



Operating Instructions

Fully-auto chemiluminescence immunoassay analyzer

Maglumi 600/800



Shenzhen New Industries Biomedical Engineering Co., Ltd (SNIBE Co., Ltd)
No.16, Jinhui Road, Pingshan New District, Shenzhen, 518122, P.R.China
Tel. + 86 755 26508518
Fax.+ 86 755 26508339



Lotus Medical Equipment Limited
26B Cameron Court, Cork Street, Dublin 8, Ireland
Tel: +00353-1-6571034
E-mail: peter@lotusme.org



Specification	Catalog Number
Maglumi 600	23020018
Maglumi 800	23020003

Information of operating instructions

Version: 2.8

Applicable Scope of Software: above 2.12.6.15

Safety Notes

1	Caution on Electromagnetic Wave Interference	2
1.1	Electromagnetic Wave Interference given by MAGLUMI® to other Equipment	2
1.2	Electromagnetic Wave Interference that may be given to the MAGLUMI® Analyzer	2
2	Installation, Movement, and Service	3
3	Other Cautions	3
3.1	Handling Chemical and Samples	3
3.2	Change of Operating Instructions	3
4	Principles for safe Use	3
4.1	Intended use / Intended Purpose	3
4.2	Common Cautions for Safety	4
5	Danger of Fire	5
5.1	Handling with Flammable Chemicals	5
6	Danger of Explosion of Flammable Vapor	5
6.1	Handling with Flammable Chemicals	5
7	Danger of Electric Shock	5
7.1	Electric Shock caused by touching the Analyzer Inside	5
7.2	Electric Shock caused by Improper Grounding	5
8	Deterioration of users state of health	6
8.1	Injury to Hand caused by Needle or Mechanism	6
8.2	Laser Burns caused by Barcode Reader	6
8.3	Chemical Burns caused by Reagents	6
8.4	Infections caused by Patient Samples	7
9	Affected processing of MAGLUMI® Diagnostic System	9
9.1	Common Cautions for Sample Station	9
9.2	Common Cautions for Reagent station	9
9.3	Common Cautions for Starter Reagents	10
9.4	Common Cautions for Waste Bag	11
9.5	Common Cautions for Wash System	11
9.6	Common Cautions for Computer system and Software	12
10	Working Conditions of MAGLUMI® Analyzer	12
11	Warning Labels on MAGLUMI® Analyzer	12

1 Caution on Electromagnetic Wave Interference

1.1 Electromagnetic Wave Interference given by MAGLUMI® to other Equipment

The use of the MAGLUMI® Analyzer may interfere with radio and television reception.

Use the cables attached at the installation for connection between the devices in the system. The proper use of the specified cables minimizes Electromagnetic Wave Interference.

Installation and service of the system or changes in the installation may never be performed by persons not authorized by SNIBE, especially never connect devices in the system with movable multiple plug sockets.

However, there is no guarantee that the MAGLUMI® Analyzer will not cause Electromagnetic Wave Interference.

- a. When the MAGLUMI® Analyzer may be the cause, turn off the power of this Instrument and check radio and television reception.
- b. If it is improved, the MAGLUMI® Analyzer probably is the cause.

1.2 Electromagnetic Wave Interference that may be given to the MAGLUMI® Analyzer

If the MAGLUMI® Analyzer is used near equipment that generates strong electric and magnetic field, noises may enter the Instrument to affect the performances and functions.

Use the cables attached at the installation for connection between the devices in the system. The proper use of the specified cables minimizes electromagnetic wave interference.

Installation and service of the system or changes in the installation may never be performed by persons not authorized by SNIBE, especially never connect devices in the system with movable multiple plug sockets.

However, there is no guarantee that the MAGLUMI® Analyzer will not be affected by Electromagnetic Wave Interference.

When some equipment may be the cause, turn off the power of the equipment and check the functions of the MAGLUMI® Analyzer. If they are improved, Interference from the equipment is probably the cause.

Try the following to correct.

- a. Move the MAGLUMI® Analyzer further away from the equipment that may be the cause.
- b. Connect the power cord of the MAGLUMI® Analyzer to an outlet that is on a different circuit from the equipment that may be the cause.
- c. Check that the other equipment, which is connected with this Analyzer, is not affected by Electromagnetic Wave Interference.

2 Installation, Movement, and Service

Installation and service may only be performed by Service Engineers of SNIBE or Technicians authorized by SNIBE, or performed under the supervision of them.

For the installation, Customers or Users should make preparation that satisfies the installation and working conditions referring to the Instruction Manual.

When moving the MAGLUMI[®] Analyzer after the delivery, contact SNIBE to avoid trouble related to the movement.

Make sure to use only equipment such as printers or screens, which have been released by SNIBE. A complete system check-up has to be performed after changes in the MAGLUMI[®] Diagnostic System.

3 Other Cautions

3.1 Handling Chemical and Samples

When performing analysis by using the MAGLUMI[®] Diagnostic System, Customers or Users should handle, keep, or process the chemicals and samples following the specified regulations etc. on their own responsibility following the suitable national regulations.

Follow the indications of each legal Manufacturer about handling, keeping, and disposal of reagent, standard solution, and sample for precision control.

3.2 Change of Operating Instructions

The contents of this Operating Instructions are subject to change without previous notice. Please get information on the actuality by Your Sales Representative.

4 Principles for safe Use

Before starting use of the MAGLUMI[®] Diagnostic System, read carefully the following Explanation for safety, and understand the contents completely.

4.1 Intended use / Intended Purpose

The MAGLUMI[®] Diagnostic System measures chemiluminescence. It is intended strictly for professional In-vitro-Diagnostic use. It is to be used only with Chemiluminescence Immunoassays, authorized by SNIBE for the MAGLUMI[®] analyzer.

4.2 Common Cautions for Safety

The MAGLUMI[®] Diagnostic System is to be used only by Professional Users.

Operate the Instrument following the indications and procedures described in Operating Instructions for the MAGLUMI[®] Analyzer. Follow all warnings, cautions, and notes indicated on the MAGLUMI[®] Analyzer and in the operating Instructions. If not, human injuries or damage to Instrument can be caused.

Caution on Safety is displayed by "Caution" or alert symbol as follows.



There is potential danger that can cause death or serious deterioration of the state of health of the patient or the user.



There is a potential danger that can prevent the instrument from intended use or intended purpose.



There is a potential danger not related to human safety directly but to create inconvenience in the use of the system.



Information needed to use the device safely and properly, especially taking account of the training and knowledge of the potential users

When using reagents or chemicals, ventilate the room well on your own responsibility. If not, trouble on health can be caused.

For keeping safety, do not modify the MAGLUMI[®] Diagnostic System, do not change the components or accessories, do not use parts either than the specified, and do not remove the safety device.

Installation at the delivery is performed by Service Engineers of SNIBE or Technicians certified by SNIBE, or performed under the supervision of them to offer a safe and precise Analyzer.

Do not perform operation and function not described in the Operating Instructions. If trouble occurs on the Diagnostic System, contact SNIBE, or Sales Agent.

Cautions indicated on the MAGLUMI[®] Diagnostic System, in Operating Instructions are prepared after careful examination; however, phenomenon beyond prediction can occur. When performing operation and maintenance, not only follow the instructions, but also pay attention always by yourself.

5 Danger of Fire

5.1 Handling with Flammable Chemicals



When using flammable chemicals such as organic solvents, there is the possibility of catching fire.

For keeping safety, only use wash buffers, starter reagents and diagnostic kits approved by SNIBE to assure not using flammable chemicals in the working process.

This instrument is not explosion-proof type. Do not use organic solvent in the direct surrounding of the analyzer whose ignition point is lower than 65°C.

6 Danger of Explosion of Flammable Vapor

6.1 Handling with Flammable Chemicals



When flammable chemicals such as organic solvents are used in the laboratory, there is the possibility of rising vapor concentrations exceeding the explosion limit concentration, explosion can be caused.

When using chemicals in the laboratory such as organic solvent, which are flammable and easy vaporized, take care of leakages and puddles, and ventilate the room sufficiently.

For keeping safety, only use wash buffers, starter reagents and diagnostic kits approved by SNIBE to assure not using flammable chemicals in the working process.

This instrument is not explosion-proof type. Do not use organic solvent in the direct surrounding of the analyzer whose ignition point is lower than 65°C.

7 Danger of Electric Shock

7.1 Electric Shock caused by touching the Analyzer Inside



When removing Cover of the MAGLUMI[®] Analyzer to work for replacing parts, cleaning etc., turn off the power, disconnect the Power Cord without fail.

7.2 Electric Shock caused by Improper Grounding



Use Power Cable furnished with the MAGLUMI[®] Analyzer. Use of Power Cable other than the specified one can cause Electric Shock.

8 Deterioration of users state of health

8.1 Injury to Hand caused by Needle or Mechanism



While running the Analyzer, do not insert your hand or anything into the Apparatus, your hand, finger or arm can be injured

Capped sample tubes can cause a crash of the needle , therefore make sure to uncap all sample tubes before the sample racks are introduced into the MAGLUMI® Analyzer. If a needle crash occurs, the procedure defined in the Chapter “Sample Station” is to be followed.

Cleaning and disinfecting actions can cause injuries by the needles, therefore cleaning and disinfecting work is to be done only if the MAGLUMI® Analyzer is not into service.
The Cleaning and Disinfection Procedure in this Operating Instructions are strictly to be followed.

8.2 Laser Burns caused by Barcode Reader



The Laser Beam of the Barcode Reader can deteriorate vision of the human eye, if the beam is focused on the retina.

While loading the Reagent Modules or the Patient Sample Racks into the MAGLUMI® Analyzer, make sure to never look into the Laser Beam of the Barcode Reader.

Fig. 8.2-1 Laser Beam Warning at the Sample Loading Area



8.3 Chemical Burns caused by Reagents



The chemical substances included in the Starter Reagents can cause chemical burns when coming in direct contact to the skin.

Before the Starter Reagents are handled or loaded into the Analyzer the package information for the starter reagents (MAGLUMI® Starter Kit) is to be read thoroughly and followed by the user.

For keeping safety, only use wash buffer and starter reagents approved by SNIBE. Loading the Starter Reagents it is

essential to ensure correct connection to starter 1 and starter 2.

Different Starter Systems can cause chemical reactions leading to chemical burns and other deteriorations of health. Loading new Starter Reagents may never be pooled.

Fig. 8.3-1: No-Pooling Warning Labels on Starter Reagent housing



8.4 Infections caused by Patient Samples



The patient samples included in the Sample Tubes can be potential infectious and therefore can deteriorate health of the users.

The reaction modules come into contact with the potentially infectious material of the patient samples, therefore the reaction modules are to be disposed of in the installed MAGLUMI® Waste Bag to avoid contact with the modules and the potentially infectious material.

The waste liquids are containing potentially infectious material of the patient samples; therefore these liquids are to be disposed according to the domestic requirements.

Cleaning and disinfecting actions can cause injuries by the needles, therefore cleaning and disinfecting work is to be done only if the MAGLUMI® Analyzer is not into service. The Cleaning and Disinfection Procedure in this Operating Instructions are strictly to be followed.

For keeping safety, the laboratory has to follow the national rules and standards for biological laboratory safety and quality control measures in diagnostic laboratories.

Fig. 8.4-1: Warning Labels on Waste Bag housing



9 Affected processing of MAGLUMI® Diagnostic System

1. For keeping safety and correctness of the MAGLUMI® Diagnostic System the Daily Maintenance and System Test with Visual inspection of needle is to be performed by the user every morning and after each exchange of starter reagents.

Additionally the Routine weekly maintenance must be performed by user according to the Operating Instructions.

2. For keeping safety and correctness of the diagnostic results, the laboratory has to use MAGLUMI® Controls according to their Information of Use.
3. The Information of Use of the used Diagnostic Kits are to be followed. The MAGLUMI® Diagnostic System may only be used under the working conditions defined in this Operating Instruction.



The detailed cleaning instruction in the Operating Instructions are to be followed strictly inclusively the choice of disinfectant.

4. Safe and intended function of the MAGLUMI® Diagnostic System can only be expected with the use of cuvettes, integrals, disposals and other accessories approved by SNIBE
5. Pooled Starter Systems can cause higher uncertainties in the creation of the diagnostic results; therefore, Starter Reagents may never be pooled.
6. Kits with different Starter Reagents may never be mixed on board of the MAGLUMI® Analyzer.
7. For keeping safety and correctness of the diagnostic results only new and non contaminated cuvettes may be used.
8. The Handling and Routine Maintenance of the Tubing System with bleaching liquid is to be done according to the MAGLUMI® Operating Instructions.
9. All produced diagnostic results should be validated by the responsible person in the validation menu of the MAGLUMI® Analyzer before release.

9.1 Common Cautions for Sample Station



1. For keeping safety and correctness of the diagnostic results only in the Operating Instruction defined Sample Tubes for the applied racks may be used.
2. The described loading and unloading procedure (never before green LED is glowing) in the Operating Instruction are to be followed.
3. The position of Sample Tube is never to be changed after loading.

9.2 Common Cautions for Reagent station



1. The description of the Integral handling before loading and the correct loading procedure in the Operating Instruction is to be followed.
2. For keeping safety and correctness of the diagnostic results the described handling and never to change the analyzer is to be followed with once opened Integrals.
3. The upgrade of a Method File may only be realized according the procedure in the Operating Instruction.

9.3 Common Cautions for Starter Reagents



1. For keeping safety of the users be sure to avoid spilling of Starter Reagents which can create harm because of their acidity.
2. The instructions in the Operating Instruction for Starter storage, handling (potentially infectious), installation and operating conditions, inclusive the expiry date for onboard stability must be realized.
3. For keeping safety, the Starter Covers are always to be closed after loading according to the Operating Instruction.
4. The formation of air bubbles is to be avoided.
5. The correct positioning of starter reagents container is to be assured.
6. The handling, maintenance and daily control of storage containers of Starter Reagents must be realized according to the Operating Instruction.

9.4 Common Cautions for Waste Bag



1. For keeping safety, only Waste Bags approved by SNIBE. may be used
2. The instructions for loading, handling and disposal of Waste Bag, in the MAGLUMI[®] Operating Instruction are to be followed..
3. Take care about the Waste Bag and make sure to empty it in time avoiding process interruptions

9.5 Common Cautions for Wash System



1. Use only MAGLUMI[®] System Liquid concentrate for the preparation under ambient operating conditions in containers approved by SNIBE
2. For keeping safety, never use freshly prepared System Liquids, but never use after defined expiry date for onboard stability.
4. Only degassed System Liquids are to be used.
5. The handling and maintenance requirements of Wash Buffer system and Wash Station inclusive description of cleaning process are to be followed.

9.6 Common Cautions for Computer system and Software



Never install Software not released by SNIBE

1. For keeping safety and correctness of the diagnostic results each Laboratory has to define a hierarchie of Access Rights for the MAGLUMI[®] Diagnostic System.
2. The instructions on "Host Connection" in the MAGLUMI[®] Operating Instruction are to be followed.
3. The Host Program is not a device manufactured and therefore not checked for compatibility with the MAGLUMI[®] Diagnostic System under the responsibility of SNIBE

There does no warrantee against data safety corruption exist.

10 Working Conditions of MAGLUMI[®] Analyzer

Operating voltage: Alternating voltage
a.c.100V-240V
Frequency
50Hz / 60 Hz

Power input: MAGLUMI 600 350VA
MAGLUMI 800 630VA

Compliance is required with the following ambient conditions during operation of the MAGLUMI[®] Analyzer:

- Application within buildings (not for outdoor use)

Temperature ranges:

- Equipment safety maintained in the range -20°C - 55°C
- Reliability of measurements maintained in the range 10°C - 30°C

11 Warning Labels on MAGLUMI[®] Analyzer

Watch out for the laser

This sign is located in the area with laser beam to the danger of the laser beam. It is on The shell of the machine



Laser window

This sign is located in the window of the machine with laser beam shooting out. It is in
The right side of the interior of the sample area



Watch out for infection

This sign is located in all area of the machine involving risk of biological infection to remind the
people around. It is on
The frontage of the waste container
The frontage of the waste tank
The right side of the sample area
The up side of the reagent area



Watch out for safety

This sign is located in the area where it is easy to get hurt to remind the safety. It is on
Below the hinge in the middle of the main support
Interior of the reagent area
Interior of the sample area



Watch out for the movement of moving component

This sign is located in the moving part of the machine to remind not touching the moving component during operation. It is in the frontage of the pipetting arm



Watch your hand

This sign is located in the component with squeezing moving part to remind the danger of clamping hand. It is on the plate covering the pipetting area



Watch out for corrosion

This sign is located in the area of the machine where the corrosive subjects are placed or it is easy to be contaminated. It is on the interior of the system liquid area(M600) and the central position of the starter area(M800)



Don't mix up

This sign is located in the area where the solution is placed to remind not mixing up the solution together. It is on

The interior of the system liquid area (M600)

The bottle of the starter

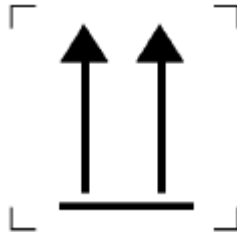


This way up

This sign is to remind the direction of the package should be upright during transport. It is on

The frontage of the package

The frontage of the wooden box



Keep away from rain

This sign is to remind keeping the package from rain during transport. It is on

The frontage of the package

The frontage of the wooden box

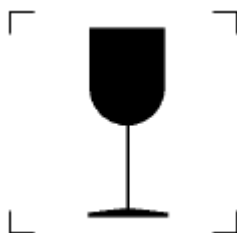


Fragile

This sign is to remind fragile subject inside, moving carefully. It is on

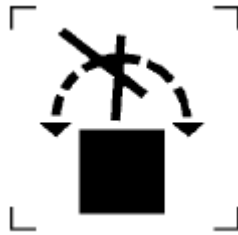
The frontage of the package

The frontage of the wooden box



Rolling is forbidden

This sign is to remind not rolling the package during transport. It is on
The frontage of the package
The frontage of the wooden box



Breaker instruction(M800)

This sign and those words like FUSE:F6AL 250V Don't cut off power when refrigerating the reagent. It is on
The above of the main switch.



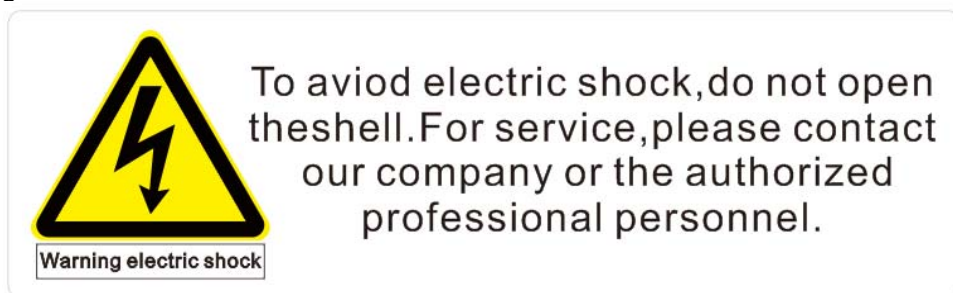
Watch out for your safety when opening the cover(M800)

This sign is to remind not opening the cover when the machine is working. It is on
The positive side of the handle on the cover



Warning for electric shock(M800)

Pay attention the words on the sign. It is on
The top right side of the shell on the back side of the machine



Content	Page
1. Intended Use	1-1
1.1 Authorization-----	2
1.2 Notation-----	2
2. Measuring Principle	2-1
2.1 Test procedure 1-step assay-----	2
2.2 Test procedure 2-step assay-----	3
2.3 Measuring Function description-----	4
2.4 Measuring principle-----	5
2.5 Calibration-----	6
3. System Description	3-1
3.1 An overview of the system components-----	2
3.2 Analyzer-----	6
3.2.1 Patients and Reagents station-----	8
3.2.2 Barcode reader and RFID reader-----	14
3.2.3 Pipetting system-----	17
3.2.4 Incubator-----	18
3.2.5 Washer-----	19
3.2.6 Measuring chamber-----	20
3.2.7 Pump systems-----	21
3.2.8 Cuvette Loader-----	22
3.2.9 Starter reagents-----	23
3.2.10 Supply connections for wash / system liquid-----	25
3.2.11 Disposal-----	27
3.2.12 Electrical and electronic connections-----	29
3.3 Computer system-----	30
3.4 Software-----	31
3.5 Connecting cables-----	32
3.6 Consumables-----	33
3.7 Analyzer Performance-----	34
3.7.1 Measuring Chamber-----	34
3.7.2 Mean Time Between Failures $\geq 1000h$ -----	34
3.7.3 Analyzer reproducibility-----	34
3.7.4 Stability test-----	34
4. Installation and Start up	4-1
4.1 Installation of the Equipment-----	2
4.1.1 Electrical connections of the system-----	3
4.1.2 Connecting supply containers for wash / system liquid and waste containers-----	4
4.1.3 Connecting starter reagents (MAGLUMI® Starter Kit)-----	4
4.1.4 Fitting the waste bag for reaction modules (MAGLUMI® Waste Bag)-----	5
4.1.5 Loading reaction modules-----	5
4.2 Switching on and starting the system-----	6
4.2.1 Starting the PC(NETBOOK) system-----	6
4.2.2 Starting the system at the beginning of the work day-----	6
4.2.3 Starting the system at the beginning of the work week-----	6
4.2.4 Starting the system after a period of three or more days of inactivity-----	7
4.3 Starting the MAGLUMI® software & system-----	9
4.4 Shutting down the MAGLUMI® software & system-----	10
4.4.1 Shutting down at the end of the work day-----	10
4.4.2 Shutting down at the end of the work week-----	10
4.4.3 Shutting down for 3 or more days inactivity-----	10

5. Operation and Structure Of The Software	5-1
5.1 Operating the software	2
5.2 Structure of the software / main menu	3
5.3 Menu items in overview	10
6. Menu [System] in detail	6-1
6.1 Menu [System] in overview	2
6.2 System Functions [Info] in detail	3
6.3 System Functions [Mode] in detail	4
6.4 System Functions [User] in detail	6
6.5 System Functions [Language] in detail	8
6.6 System Functions [Wash Pipe] in detail	8
6.7 Exiting the MAGLUMI® program	9
7. Menu [Definitions] in detail	7-1
7.1 Definitions in overview	3
7.2 <Test> icon in detail	4
7.2.1 [Assay Selection] icon, <Export> in detail	5
7.2.2 [Assay Selection] icon, <Import> in detail	5
7.2.3 [Assay Selection] icon, <TEST> in detail	7
7.2.4 [Assay Selection] icon, <Edit> in detail	7
7.3 <Control> icon in detail	19
7.3.1 [Control Selection] icon, <Add> & <Edit> in detail	20
7.3.2 [Control Selection] icon, <Delete> in detail	26
7.4 <Group> icon in detail	27
7.4.1 [Group Selection] icon, <Add>, <Insert>, <Edit> & <Copy> in detail	28
7.4.2 [Group Selection] icon, <Delete> in detail	34
7.5 <Sender> icon in detail	35
7.5.1 [Sender Selection] icon, <Add>, <Edit>, & <Copy> in detail	36
7.5.2 [Sender Selection] icon, <Delete> in detail	37
7.6 <Dilut.> Icon in detail	39
7.6.1 [Dilution] – Saving and Canceling	40
7.6.2 [Dilution] – Assay	40
7.6.3 [Dilution] – Assay Selection	40
7.6.4 [Dilution] – Dilution Selection	41
7.6.5 [Dilution] –Selected Dilutions	42
7.6.6 <Dilute> How to set a dilution	45
8. Menu [Process] in detail	8-1
8.1 Process in overview	2
8.2 <Init> icon	2
8.2.1 <Init> icon <OK> in detail	3
8.2.2 <Init > icon <Cancel> in detail	4
8.3 <Continue> icon	4
8.4 <Return Asy> icon	4
8.5 <Low Level> icon	5
8.6 < Warning Opt.> icon	5
9. Menu [System Test] in detail	9-1
9.1 System Test in overview	2
9.2 System Test in detail	2
9.2.1 [System Test] dialog [Priming] section in detail	3
9.2.2 [System Test] dialog [System test] section in detail	4
9.2.3 [System Test] dialog exiting, confirmation, and information	5
9.3 Placing Light Check on the analyzer	7

10. Menu [Report] in detail	10-1
10.1 Report in overview	2
10.2 <Journal> icon in detail	3
10.2.1 [Journal] icon <Sort> in detail.....	4
10.2.2 [Journal] icon <Print> in detail.....	5
10.2.3 [Journal] icon <Recalc.> in detail	6
10.2.4 [Journal] icon <Online> in detail.....	7
10.2.5 [Journal] icon <Edit> in detail	8
10.2.6 [Journal] icon <Delete> in detail.....	9
10.2.7 [Journal] icon <Valid> in detail	10
10.2.8 [Journal] icon < Remeasure > in detail.....	11
10.3 <Valid> icon in detail.....	12
10.3.1 [Valid] icon, <Sort> in detail.....	13
10.3.2 [Valid] icon <Online> in detail.....	14
10.3.3 [Valid] icon <View> in detail	15
10.3.4 [Valid] icon <Delete> in detail.....	16
10.3.5 [Valid] icon <Print> in detail.....	17
10.4 [Calibrator] icon in detail.....	18
10.4.1 [Calibrator] icon <Sort> in detail	19
10.4.2 [Calibrator] icon <Online> in detail	20
10.4.3 [Calibrator] icon <View> in detail.....	21
10.4.4 [Calibrator] icon <Delete> in detail	22
10.4.5 [Calibrator] icon <Print> in detail	22
10.5 [Control] icon in detail.....	24
10.5.1 [Control] icon <Sort> in detail.....	25
10.5.2 [Control] icon <Online> in detail	26
10.5.3 [Control] icon <View> in detail.....	27
10.5.4 [Control] icon <Delete> in detail	28
10.5.5 [Control] icon <Print> in detail	28
10.6 [System Test] icon in detail	30
10.7 [QC] icon in detail.....	31
10.8 [Report] icon in detail	31
11. Menu [Patients&Reagents]-Patient Section in detail	11-1
11.1 [Patients] section in overview.....	2
11.2 [Sample Loading] dialog in detail	3
11.2.1 [Rack Station] in detail.....	4
11.2.2 [Sample- ID] in detail	5
11.2.3 [Assay Group/ Assay List]	7
11.2.4 [Loading] in detail	9
11.2.5 exiting and confirmation	17
12. Menu [Patients&Reagents]-Reagent Section in detail	12-1
12.1 [Reagents]section in overview	2
12.2 [Reagent Loading] section in detail.....	3
12.2.1 [Reagent Integral Area] section in detail	4
12.2.2 [Reagent Integral Data] section in detail	8
12.2.3 [Calibration] section in detail	11
12.2.4 Exiting, Confirmation, & Information.....	19
13. Consumable Handling	13-1
13.1 Consumable handling in overview	2
13.2 Consumable handling instructions	2
13.2.1 Reaction Module handling.....	2
13.2.2 Analyzer Liquids handling	4
13.2.3 Waste Disposal	9
13.2.4 Light Check Handling	10

14. Handling Reagents	14-1
14.1 Reagent handling in overview	2
14.2 Reagent Integrals in detail	2
14.2.1 Physical Construction of the Integral.....	2
14.2.2 RFID Chip of the Integral.....	3
14.3 Loading Reagents	4
14.3.1 Integral preparation	4
14.3.2 Placing integrals on the analyzer	5
14.3.3 Particular aspects of loading reagents in combi-assays	7
14.3.4 Removing integrals from the analyzer.....	7
14.3.5 Proper storage and handling of integrals	7
14.4 Manual loading of integrals	8
15. Handling Patient Samples	15-1
15.1 Patient sample handling in overview	2
15.2 Sample racks in detail	2
15.2.1 Physical construction of the sample rack.....	2
15.2.2 Barcode layout of the sample rack	3
15.3 Loading samples	4
15.3.1 Sample rack preparation	5
15.3.2 Loading SNIBE External reagents in sample racks	7
15.3.3 Placing sample racks on the analyzer.....	7
16. Host Result Management	16-1
16.1 Host Result Management in Overview.....	2
16.2 Host Setup in MAGLUMI® software	2
16.2.1 ASTM Setup dialog	2
16.2.2 Online icons in the MAGLUMI® software.....	3
16.3 Types of possible Host Connections in MAGLUMI® software.....	4
16.3.1 Host Query	4
16.3.2 How To send results to the LIS	5
16.4 MAGLUMI® software communication format	7
16.4.1 Inquiry Reagent Information	7
16.4.2 LIS return the assay information	8
16.4.3 Sending test results.....	9
17. Quality Control	17-1
17.1 Quality Control in overview	2
18. Care and Maintenance	18-1
18.1 Care and Maintenance in overview.....	2
18.2 Daily Maintenance instructions	3
18.3 Weekly Maintenance instructions	4
18.4 Monthly Maintenance instructions.....	5
19. System Warnings and messages	19-1
19.1 System warnings and messages in overview	2
19.1.1 <Message Box > dialog, <OK> in detail.....	3
19.1.2 <Message Box > dialog, <View> in detail	4
19.1.3 <Message Box > dialog, <Print> in detail.....	5
19.1.4 <Message Box > dialog, <Delete> in detail.....	6
19.1.5 <Message Box > dialog, <Sort> in detail	8
19.2 Emergency stop of the analyzer	9
19.3 Messages, problems, and corrective action on the MAGLUMI® Analyzer.....	12
19.3.1 Common problems, and corrective action on the MAGLUMI® Analyzer.....	12
19.3.2 "System Test" <BGW> Troubleshooting on the MAGLUMI® Analyzer	13
19.3.3 "System Test" <LC> Troubleshooting on the MAGLUMI® Analyzer	14
19.3.4 Sample result Troubleshooting on the MAGLUMI® Analyzer.....	16

19.3.5 Common Error messages and solutions on the MAGLUMI® Analyzer 17
 19.4 Error messages and recovery action 18

20. Appendix A-Needle Coordinate 20-1

1.1 Preparation for coordinate 2
 1.2 Procedures of Coordinates 4
 1.3 Adjustment of reference position 4
 1.4 Adjustment of pipetting needle..... 7
 1.4.1 Adjustment of< First Sampling> position..... 8
 1.4.2 Adjustment of Second Sampling after Incubate 11
 1.4.3 Adjustment of Second Sampling after Wash..... 14
 1.5 Washing position adjust 19
 1.6 Sample Reagent area position adjust 21
 1.6.1 Sample area position adjust 22
 1.6.2 Reagent area position Adjust 26
 1.7 Z-Dispense position adjust..... 33
 1.8 Adjustment of the pipetting needle in Z- Start position 37

21. Appendix B-Software Upgrade 21-1

1.1 Operating Software Upgrade 2
 1.1.1 Kernel or structure of operating software upgrade..... 2
 1.1.2 Operating software patch update 7
 1.2 Master control PCB Programs' Upgrade..... 8
 1.2.1 M600-01-E00-COP or M800-01-E00-COP write the flash out of the upgrade program 8
 1.2.2 M600- 02~04 board or M800-02~05 program upgrade writing flash out 12

Chapter 1

Intended Use

1.1 Authorization	2
1.2 Notation.....	2

1.1 Authorization

The user manual and the operation of the MAGLUMI[®] Chemiluminescence analyzer are to be used by authorized personnel only.

The user manual is intended to be used for MAGLUMI[®] 600 /800 chemiluminescence analyzers

1.2 Notation

To facilitate the use of this handbook, the following repeatedly occurring symbols will be used:

- Names of dialog boxes, options and queries in dialog boxes are printed in bold and set in [].

Example:

Menu **[Definitions]**, dialog box **[Definition]**, **[Name]**, **[Password]**

- Inscriptions of switches are printed in bold and set in < >.

Example:

<OK> **<Add>**

- Entries made by the user are printed in bold and set in “ ”.

Example:

[Sample volume] “2” [μl]

This makes it possible to distinguish quickly between the three most important functions when operating the program:

Program defaults **[]**

Icon (button) inscriptions **<>**

User entries **“ ”**



Caution on Safety is displayed by "Caution" or alert symbol, letterform is in bold and italic

Chapter **2**

Measuring Principle of the **MAGLUMI[®]** Immunoassays

2.1 Test procedure 1-step assay	2
2.2 Test procedure 2-step assay	3
2.3 Measuring Function description	4
2.4 Measuring principle	5
2.5 Calibration	6

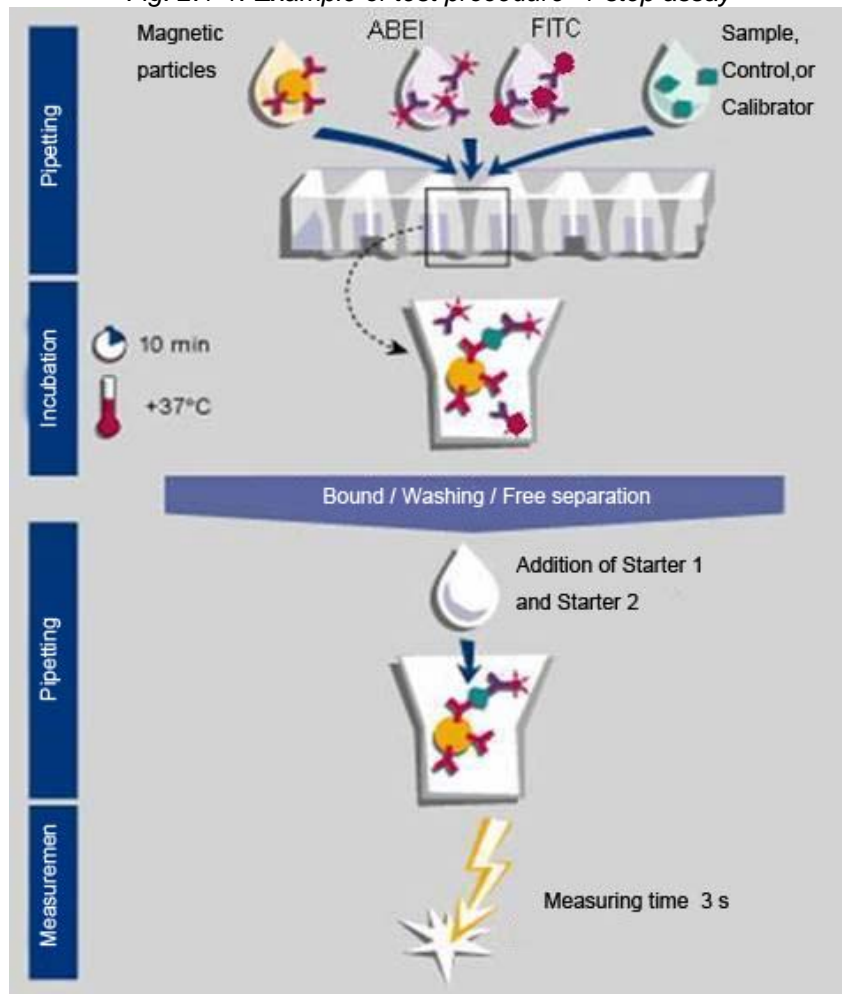
2.1 Test procedure 1-step assay

A 1-step assay refers to a test or assay that has:

- **1 incubation sequence** (the time of incubation may range depending on the assay).
- **1 wash sequence** (the amount of washing for this sequence is assay dependent).

Most assays that are 1-step have an average incubation time of 10 minutes. Fig. 2.1 -1 is only an example. Pipetting sequences are also assay dependent.

Fig. 2.1-1: Example of test procedure "1-step assay"



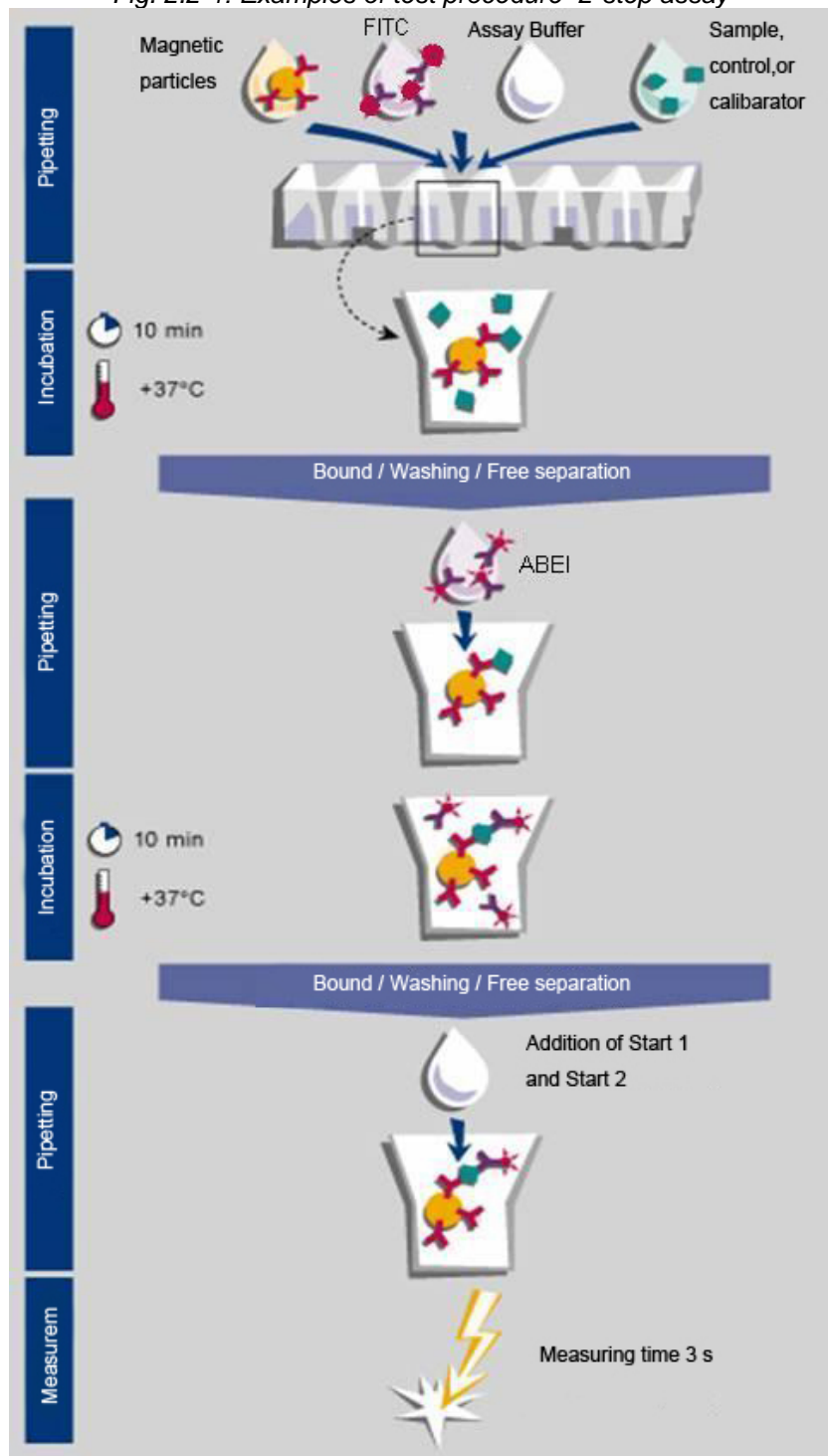
2.2 Test procedure 2-step assay

A 2-step assay refers to an assay that has:

- **2 incubation sequences** (the time of incubation may range depending on the assay).
- **2 wash sequences** (the amount of washing for each sequence is assay dependent).

Most assays that are 2-step have an average incubation time of 10 minutes each. Fig. 2.1.2-1 is only an example. Pipetting sequences are also assay dependent.

Fig. 2.2-1: Examples of test procedure “2-step assay”



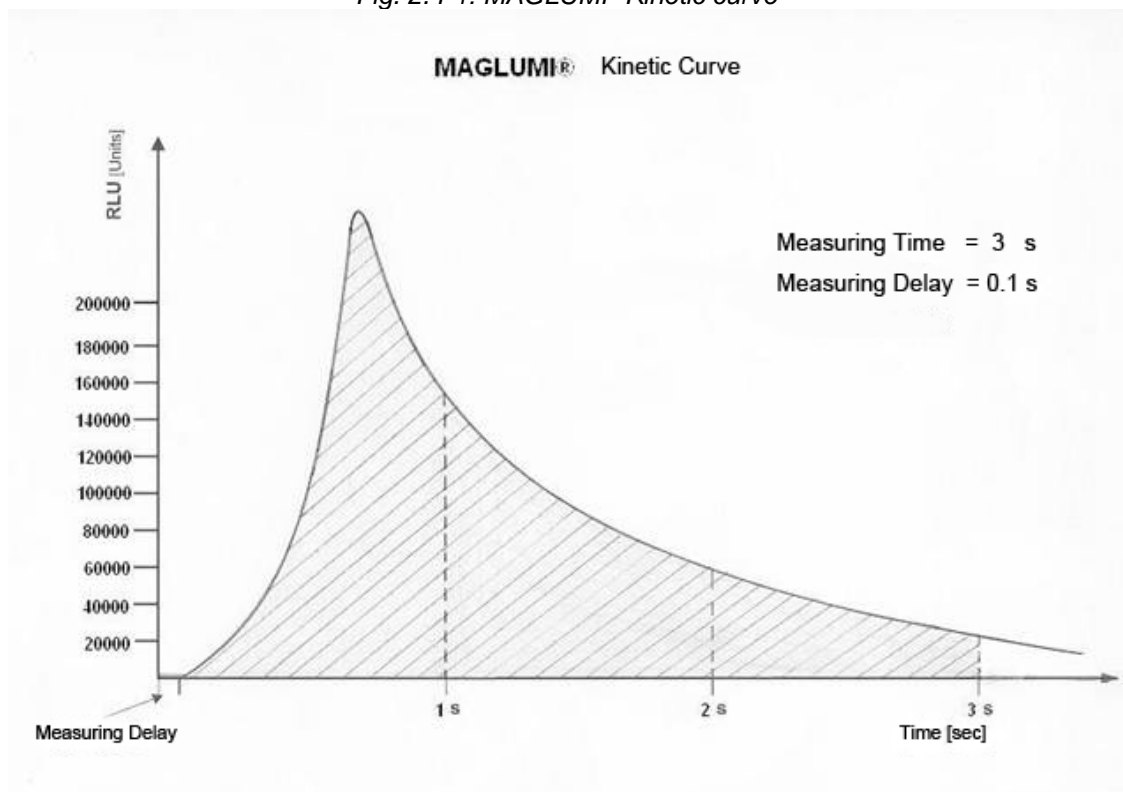
2.3 Measuring Function description

- The **chemically emitted light** is measured by a selected high-sensitive, low-noise **photo multiplier [PMT]**. The linear measuring range of the photo multiplier is 300 - 650 nm. The light peak of the chemiluminescence is emitted at a wavelength of 420 nm.
- The PMT is operating as an ultra-fast photo counter. The pulses are amplified by a rapid electronic amplifier. A circuit, which suppresses the PMT signal-noise is also implemented in the PMT box.
- Not the number of counts, but the **Relative Light Units [RLU]** are used as units of the measurement for the raw data, which is then multiplied by the RLU factor, that allows the compensation of the inevitable, individual fluctuations of the cathode sensitivity of the PMT.

2.4 Measuring principle

- After the last wash cycle has been completed, the reaction module is transported into the measuring chamber.
- When the first cavity of the reaction module reaches the position under the injection head, starter reagent 1 will be injected into the first cavity.
- After a pump delay time of 2.5 sec the starter reagent 2 will be injected into the same cavity to start the chemiluminescence reaction.
- After the measuring delay time of 0.1 sec, the measuring signal is obtained and integrated over the measuring period of 3.0 sec.

Fig. 2.4-1: MAGLUMI® Kinetic curve



2.5 Calibration

Data reduction is performed using a master curve with **2-point recalibration**.

The starting point of data reduction is the **master curve**, stored in RFID Tag of the reagent kit..

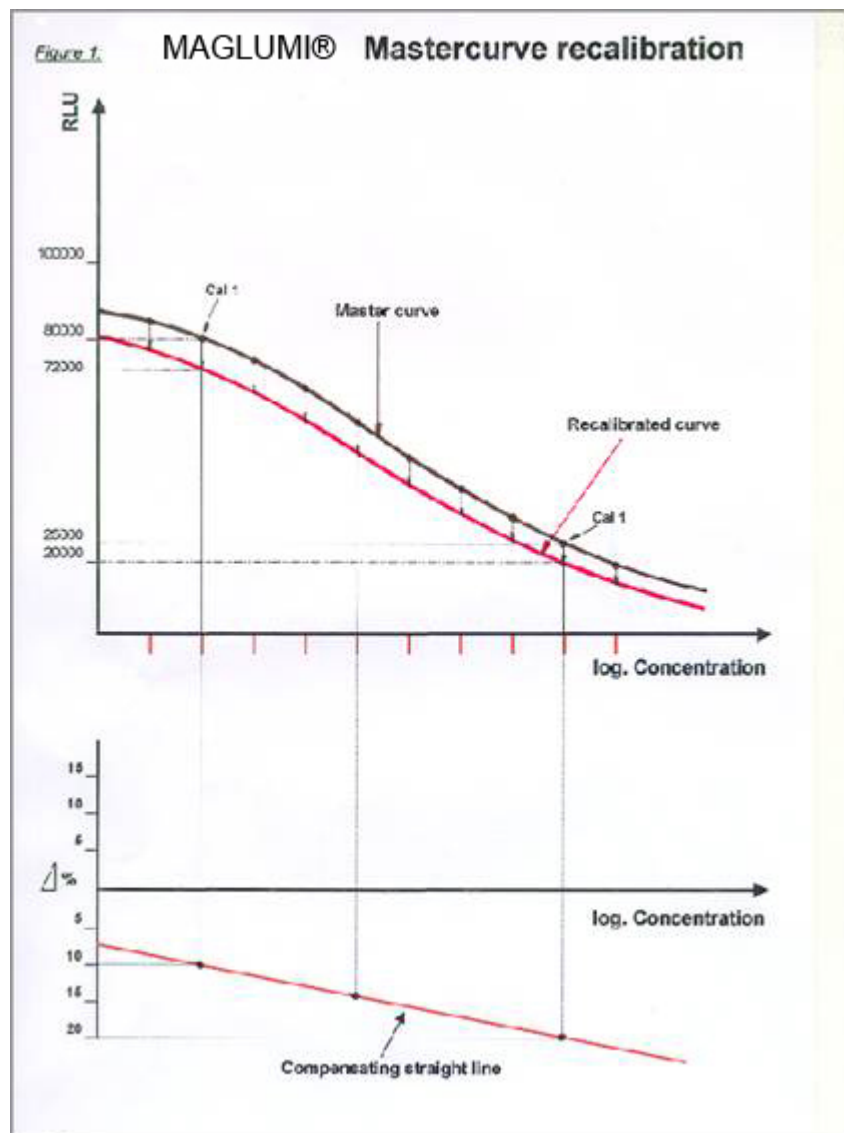
To compensate differences between reagent lots, different analyzers and environmental conditions, **assay calibration** must be run and validated according to the indications reported in the assay Instructions for Use (indications may vary per assays).

The measuring signals of the calibrators allow the shift of all master curve points to a **working curve**, corresponding with the actual conditions during measurement.

Brief description:

- The stored **master curve** is generally defined with 10 master curve base points.
- Two **calibrators** with defined concentration values are measured. These measured signals (RLU) are compared with the master curve signal of the corresponding calibrator concentrations.
- The **relative difference** between the measured RLU and the master RLU of the calibrators is calculated and a linear extrapolation is performed between the recalculated RLU (Y-axis) and the logarithmic (Log) concentrations (X-axis).
- Based on appropriate compensation factors, a **re-adjustment** of the master curve points is made in order to achieve, by a "cubic spline function", the **working curve**.

Fig. 2.5-1: Calibration concept: example



For keeping safety of the diagnostic results, quality control measures are to be realized, such as routine controls or calibration issues, which are defined in this Operating Instruction.

Chapter 3

System Description

3.1 An overview of the system components	2
3.2 Analyzer	6
3.2.1 Patients and Reagents station	8
3.2.2 Barcode reader and RFID reader	14
3.2.2.1 Barcode reader	14
3.2.2.2 RFID Reader	16
3.2.3 Pipetting system	17
3.2.4 Incubator	18
3.2.5 Washer	19
3.2.6 Measuring chamber	20
3.2.7 Pump systems	21
3.2.8 Cuvette Loader	22
3.2.9 Starter reagents	23
3.2.10 Supply connections for wash / system liquid	25
3.2.11 Disposal	27
3.2.12 Electrical and electronic connections	29
3.3 Computer system	30
3.4 Software	31
3.5 Connecting cables	32
3.6 Consumables	33
3.7 Analyzer Performance	34
3.7.1 Measuring Chamber	34
3.7.2 Mean Time Between Failures \geq 1000h	34
3.7.3 Analyzer reproducibility	34
3.7.4 Stability test	34

3.1 An overview of the system components

The MAGLUMI[®] 600/800 Analyzer is a system consisting of the following components:

- Analyzer
- LENOVO PC
- System operating software (based on Windows application)
- Connecting cable and connecting hoses
- Consumables
- Supply and waste containers

Fig. 3.1-1: The system components.

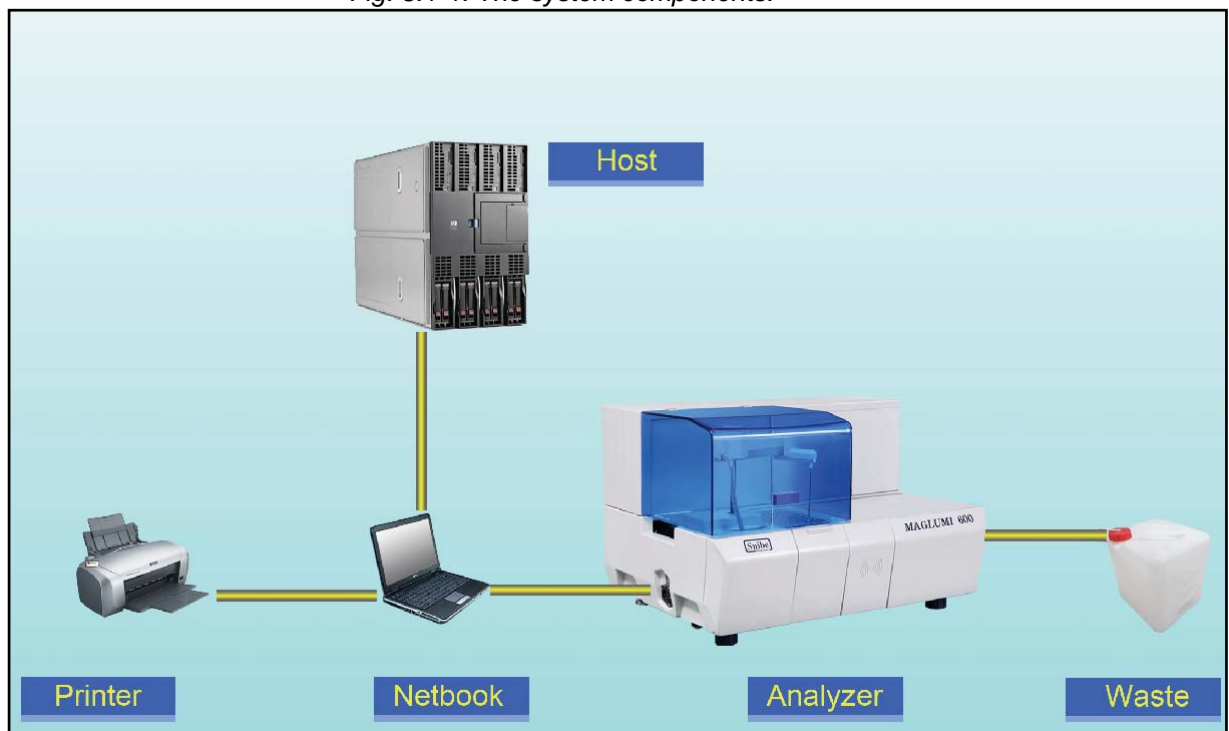


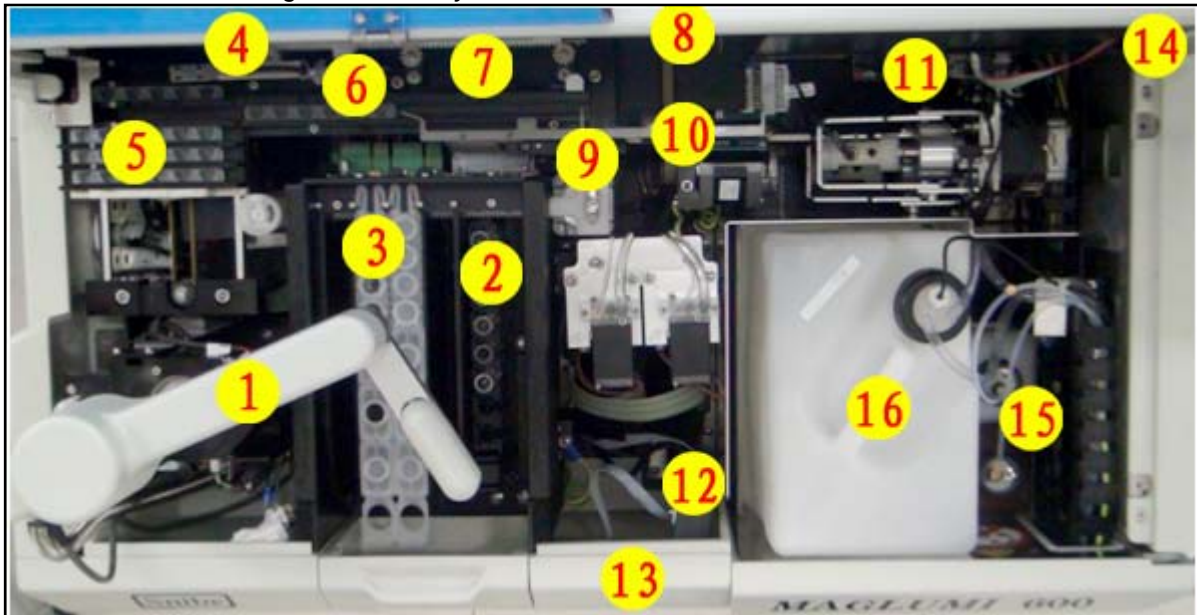
Fig. 3.1-1.1: The MAGLUMI 600 analyzer.



Fig. 3.1-1.2: The MAGLUMI 800 analyzer.

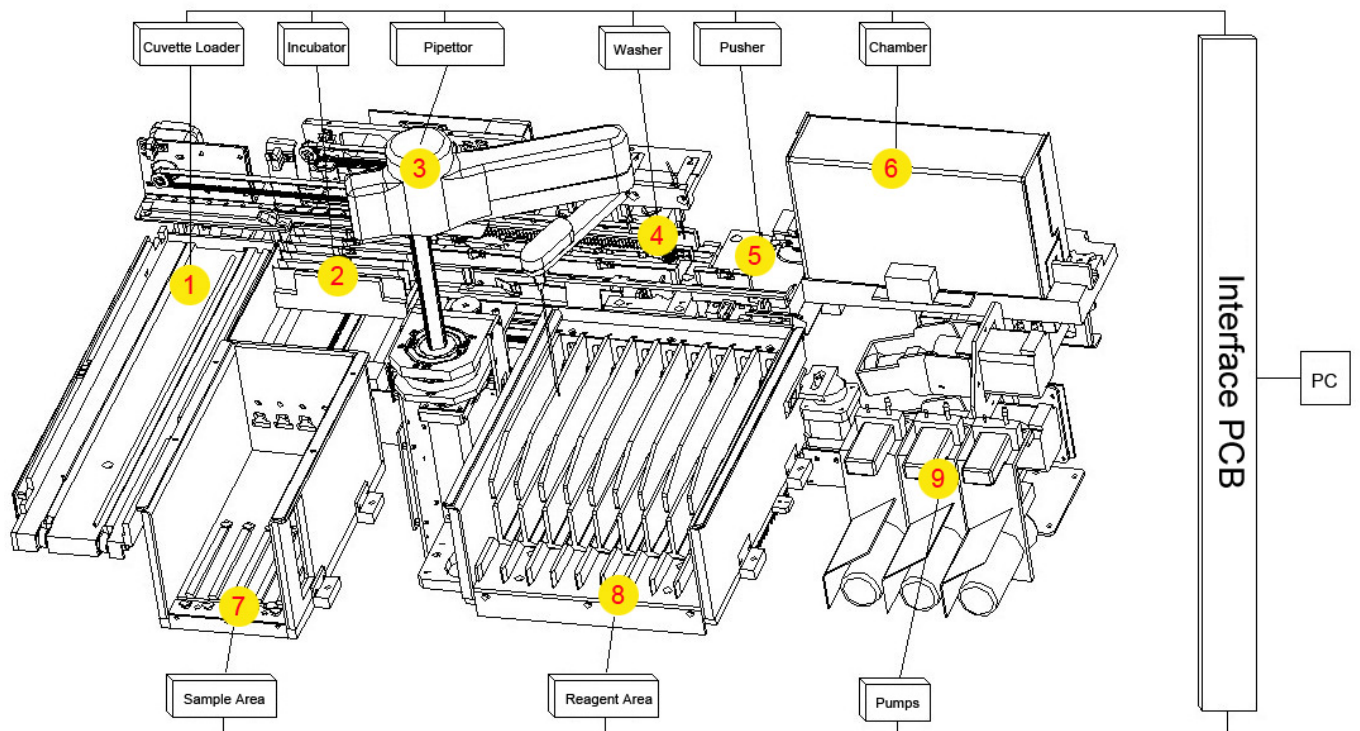


Fig. 3.1-2: The system internal assemblies MAGLUMI 600



1. Pipettor
2. Sample Area
3. Reagent Area
4. Washer loader
5. Incubator
6. Washer transport
7. Washer lift
8. Diluters
9. Back-transport
10. Pusher
11. Measuring chamber
12. Barcode reader
13. RFID reader
14. Waste bag
15. Starter Area
16. System Liquid Area

Fig. 3.1-2.1: The system internal assemblies MAGLUMI 800



1. Cuvette Loader
2. Incubator
3. Pipettor
4. Washer
5. Pusher
6. Chamber
7. Sample Area
8. Reagent Area
9. Pumps

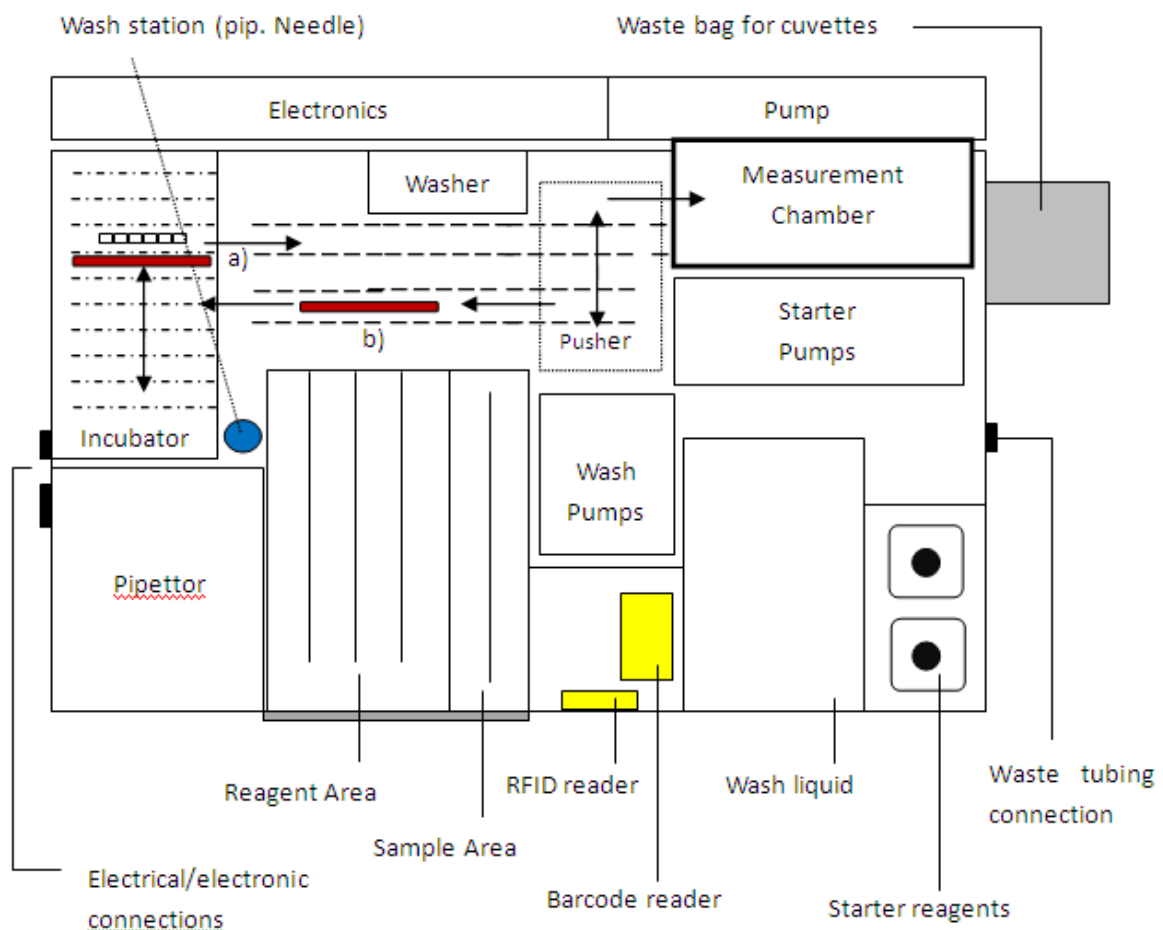
3.2 Analyzer

The MAGLUMI[®] 600/800 Analyzer is a fully automatic system, whose operation is timed in cycles. A differentiation is made between the machine cycle (duration of the processing of a reaction module) and the microcycle (1 machine cycle corresponds to 7 microcycles). The bottom bar on the screen shows the cycle that the analyzer has currently reached (e.g. **66:4** = machine cycle 66, microcycle 4) and the analyzer status. Some displays that describe the analyzer status are for example:

- **Active** Analyzer active. Tests are being processed.
- **Priming** Analyzer fluidic systems are being flushed.
- **Finished** All actions are ended.

The most important components and operation of the MAGLUMI[®] 600 Analyzer

Fig. 3.2-1: Schematic diagram of the components of the MAGLUMI[®] Analyzer (view from above without cover and pipetting units).



Pipetting area:

- a) 1st pipetting (also called left pipetting position)
- b) Pipetting for 2-step assays (also called right pipetting or mixing step)

Waste Tube connections:

- (1) Waste liquid (from pipetting system)
- (2) Waste liquid (from Washer)

Electrical / electronic connections:

- 1. Serial interface
- 2. Power connection
- 3. Power switch (main)
- 4. Power switch (deputy)

In the operating condition, the components are secured by covers and only the reaction module loader, the Patients and Reagents stations as well as the pipetting units are visible. A sheet of Plexiglas at the front of the analyzer provides protection against injury and prevents manual intervention during the automatic process.

Before shutting down the system for long periods

If the system is to be shut down for a lengthy period, refer to chapter 4 for detailed instructions.

After the system has been shut down for a lengthy period

In order to ensure that the analyzer will operate error-free, we recommend that you switch the system on 1 hour before the first measurement to allow the photomultiplier (measuring chamber) to stabilize, and enable all temperature-controlled areas to operate uniformly.

Before starting up the analyzer, see chapter 4 for detailed instructions.

3.2.1 Patients and Reagents station

The Patients and Reagents station is accessible from the front via a swivel flap.

Opening the flap automatically loads the Patients and Reagents-loading dialog in the operating software. Since the temperature of Patients and Reagents station refrigerated area which is kept within 8 – 15 °C, the flap is required to close after loading sample rack or reagent.

The Patients and Reagents station contains 2 guide rails for sample racks and a light-emitting diode (LED) for each track on the rear panel.

LED green: Track empty or sample rack already processed.

LED orange: Track currently processing and not yet finished.

Sample rack

Fig. 3.2.1-1: An example of the sample rack for 8 samples



Once a orange LED is lit for a rack in the sample area, do not pull out the sample rack or change any sample positions.

i

ing and operating the sample rack

Ensure that you fill the sample rack correctly by placing the sample tubes upright in the sample rack. The liquids to be pipetted must be free of foam and bubbles on the surface to ensure correct pipetting.

On the user side, the sample rack has a handle and on the equipment side a stud for mechanical locking. Take hold of the rack by its handle, insert it into the guide rail, and slide it into the sample station up to the limit stop. Engagement of the rack is audible and perceptible. The software detects when the sample rack is correctly inserted and displays this on the monitor screen.

CAUTION

When using barcode labels, ensure that the barcode labels face towards the right (open side of the rack) when loading. Otherwise they cannot be properly read.

Fig. 3.2.1-2: Patients and Reagents station.

**Sample loading dialog**

When a sample rack is correctly inserted, this is recognized by the operating software and displayed on the monitor screen. When barcode labels are used, the IDs of the patient samples are sent to the computer and automatically displayed in editable entry fields in the sample-loading dialog. Additional patient data can be automatically called up from a host computer or entered manually.

If no barcode labels are used, enter the data in the editable entry fields manually using your work list.



Only supplied, MAGLUMI® 600/800 approved sample racks may be used.

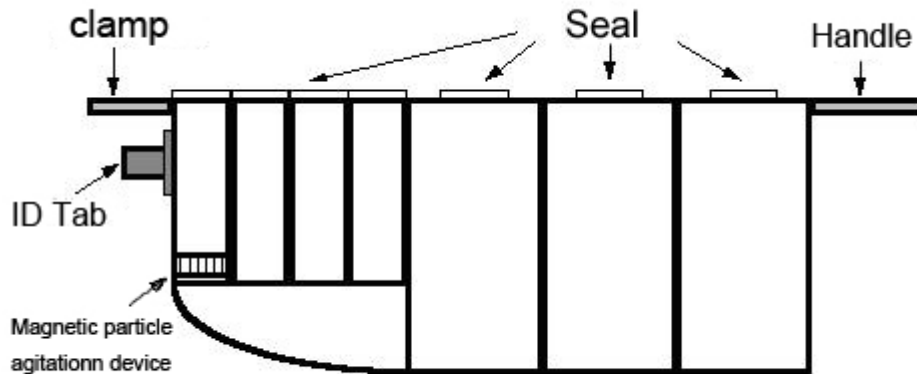
The use of unauthorized rack types are forbidden and may cause damage to the analyzer!

Refrigerated function of the Patients and Reagents Area

Reagent cooling (8-15°C) with independent power switch

The reagent station is closed at the top with a transparent Plexiglas sheet provided with holes for the pipetting needles.

Fig. 3.2.1-3: Reagent Integral



The reagent station contains 4 tracks for Reagent Integrals(9 tracks for Maglumi 800). An integral is a plastic mold that contains all reagents required for any given assay(up to 7 containers/vials). The first vial of each Reagent Integral contains the magnetic particles, which are held in suspension by a rotating gear rack when the analyzer is switched on

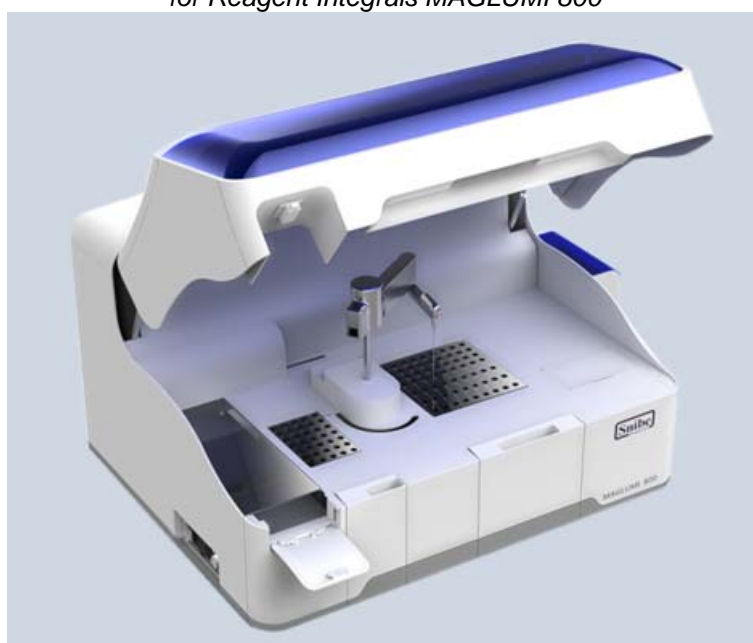
A RFID Tag ,storing all the reagent data, is located on one side of the Reagent Integral .The information can be read by RFID Reader or be entered by hand.

The handle for inserting and removing the integral from the reagent area. The clamp for correct position holding of integrals inside the reagent area.

Fig. 3.2.1-4: Patients and Reagents station with 2 sample tracks and 4 tracks for Reagent Integrals MAGLUMI 600.



Fig. 3.2.1-5: Patients and Reagents station with 5 sample tracks and 9 tracks for Reagent Integrals MAGLUMI 800



Operating the reagent station:

Open the swivel flap of the reagent station only briefly for loading purposes to maintain the refrigerated ambient of the reagent station. Remove the protection foil from the Reagent Integral. When the RFID Tag is put near the sensing area of the RFID reader, a "tick" sounds as it has been read correctly.

Take hold of the Reagent Integral (prepared according to the manufacturer's instructions) by its handle and slide it into the selected reagent station track. Insert the integral up to the limit stop. A correctly inserted integral is recognized by the software and displayed on the monitor screen.

Always allow the Reagent Integral to remain in the reagent station for a minimum of 30 minutes before use. During this time, the magnetic particles in the analyzer will be automatically set in motion and completely re-suspended.



Before using the Reagent Integrals, read the IFU (instructions for use) provided in the reagent package (storage, preparation)!

Patients and Reagents loading dialog

The tracks (1-4) on MAGLUMI 600 (tracks 1-9 on MAGLUMI 800) for Reagent Integrals are displayed in the **[Patients and Reagents Loading]** dialog. Each track occupied appears as a button and bears the assay name of the Reagent Integral and the number of remaining determinations. The calibration status is displayed by two colored windows.

When an integral is properly inserted, it is recognized by the operating software and displayed in dark gray on the monitor screen. The reagent data are sent to the computer and automatically displayed in entry fields in the **[Patients and Reagents Loading]** dialog. If the reagent data is not recognized (the button of the integral bears the designation **[Error]**). It is also possible to enter the data in the editable entry fields from the label inscription.

Integrals, which have been previously loaded and are loaded again, are recognized by the system and checked.

Fig. 3.2.1-6: Patients and Reagents loading dialog for Maglumi 600

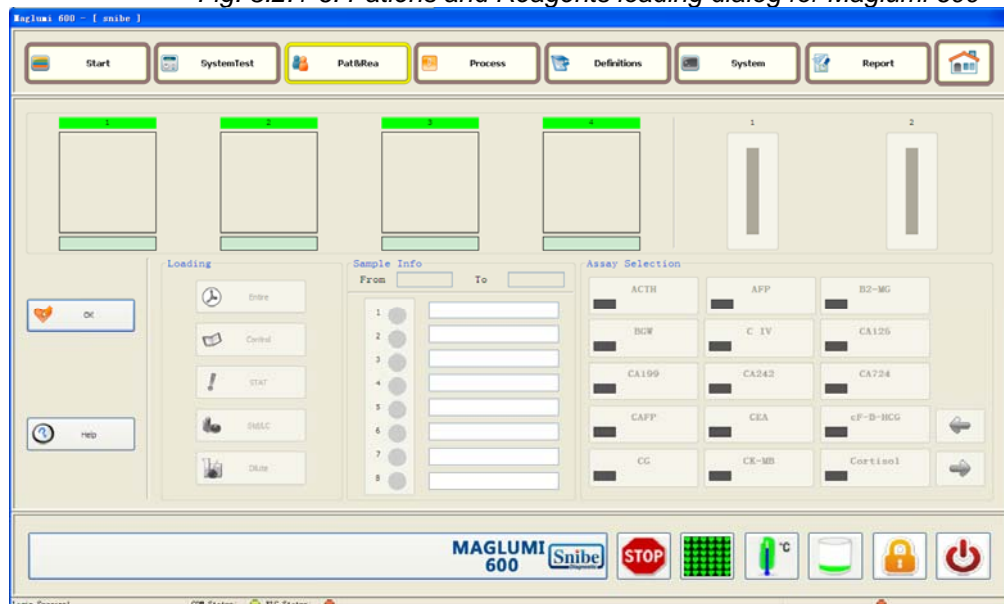
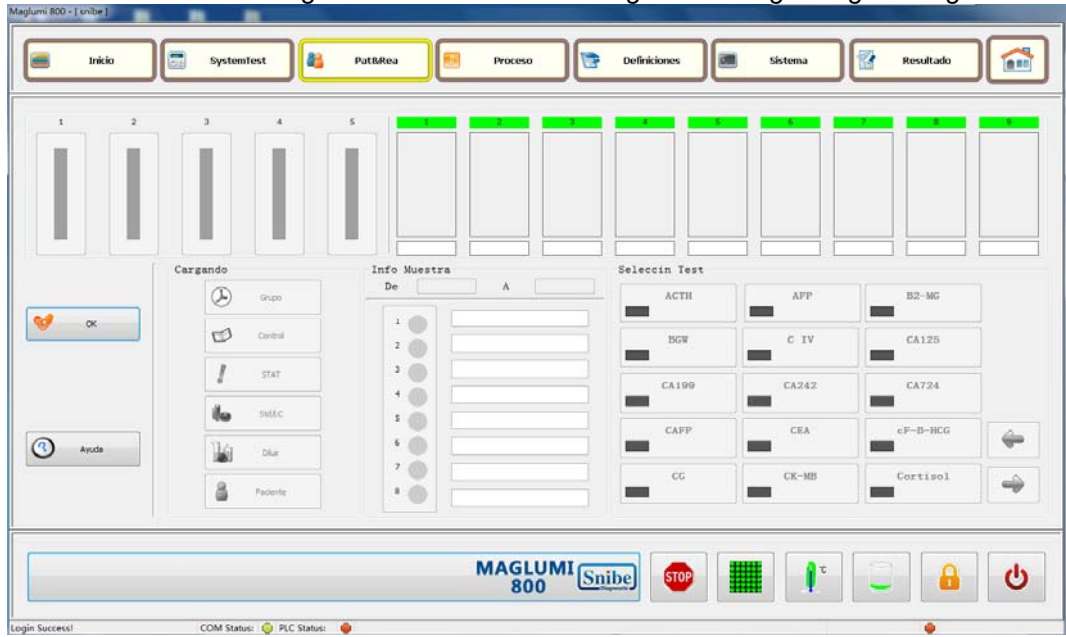


Fig. 3.2.1-7: Patients and Reagents loading dialog for Maglumi 800



3.2.2 Barcode reader and RFID reader

3.2.2.1 Barcode reader



The barcode reader is a laser beam. Never look directly into the barcode reader, as this can damage the eyes!

The barcode reader is located between the Patients and Reagents stations. Upon opening the flap of the sample station, the barcode reader switches on automatically.

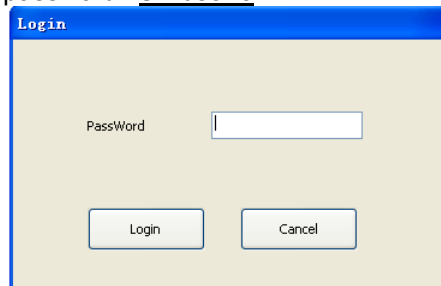
Upon inserting a sample rack, the sample rack type and the barcode labels on the test tubes are read automatically. The rack inserted is indicated on the screen in the [Sample Loading] dialog and the sample identifications are transferred to the respective entry fields.

The Requirement of barcode printing:

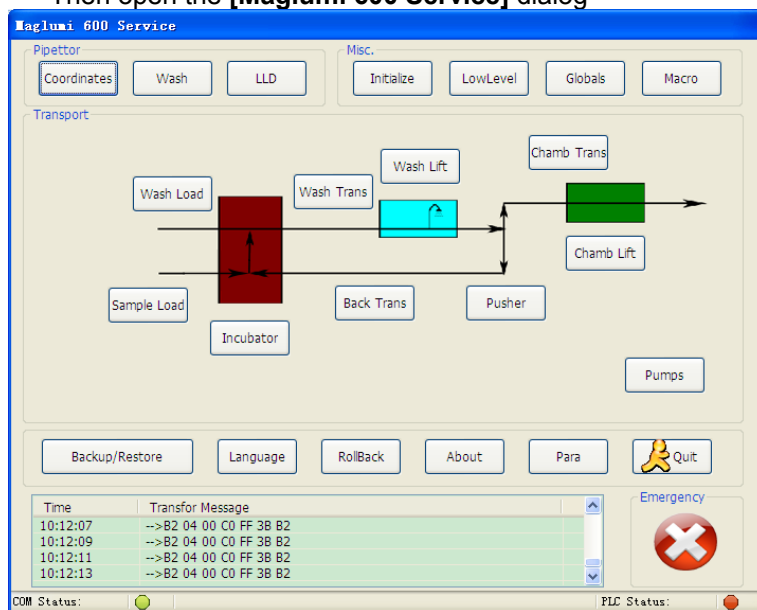
Type Of Encoding	Range of Data length	Need for check digit (y/n)	Barcode Width	Barcode height	Recommended width	Recommended height
Code128 /EAN128	1-25 characters	Y	0.3mm-0.8mm	N/A	0.33mm	10mm
Code39	1-25 characters	N	0.3mm-0.8mm	N/A	0.33mm	10mm
Codabar	1-25 characters	N	0.3mm-0.8mm	N/A	0.33mm	10mm
Code93	1-25 characters	Y	0.3mm-0.8mm	N/A	0.33mm	10mm
Code UPCA/UPCE	8 characters	Y	0.3mm-0.8mm	N/A	0.33mm	10mm
Code EAN 8/13	8 or 13 characters	Y	0.3mm-0.8mm	N/A	0.33mm	10mm
Code2/5 Interleaved	2-24 characters	N	0.3mm-0.8mm	N/A	0.33mm	10mm
The width of barcode's black area is at least seven times of the width of the barcode						

When your type of encoding is Code39, Codabar or Code2/5 Interleaved, the barcode reader couldn't recognize the check digit, In this case ,the wrong information will be read. So if you have print your barcode with a check digit, Follow the steps below :

1. Double click the  icon on the desktop to and input the password : **snibe923**



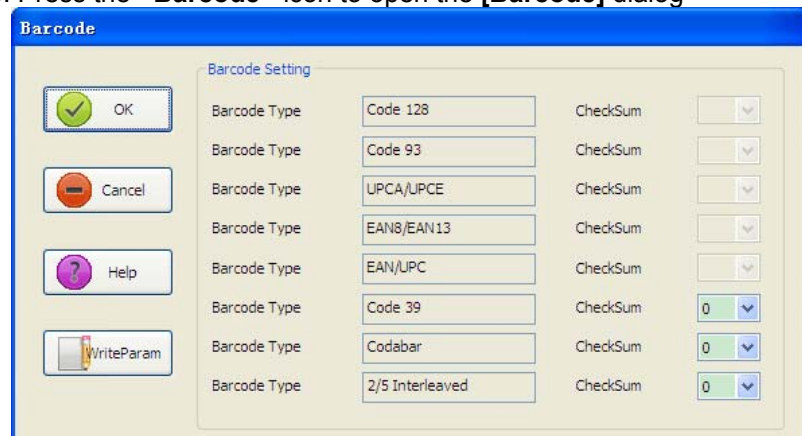
Then open the **[Maglumi 600 Service]** dialog



2. Press the **<Globals>** icon to open the **[Globals]** dialog



3. Press the **<Barcode>** icon to open the **[Barcode]** dialog



4. According to your type ,change the corresponding value of the **<Checksum>**

3.2.2.2 RFID Reader

When the RFID Tag side of the reagent kit faces the sensing area of the RFID reader within 30mm, the RFID Reader will beep once signifying a correct reading. Then choose an unoccupied lane to insert the reagent kit and the information will be shown on the **[Reagent loading]** dialog



When there are some reagent kits to be loaded, the procedure should be operated by the steps above one by one !

3.2.3 Pipetting system

The aspiration and dispensing of samples and reagents is carried out by one pipetting unit with special Teflon coated pipetting needle.

pipetting unit

Used for patient samples, controls, sample diluent and calibrators. Also it is used for reagent. The pipetting needle is primed/cleaned in wash station.

The pipetting unit is software-controlled and automatically positioned in the appropriate pipetting area.

Fig. 3.2.3-1: Pipetting needle for pipetting unit



To ensure correct aspiration, the liquids to be pipetted must have no foam on the surface!

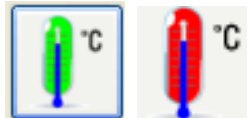
Clot detection

The left pipetting unit contains a special system allowing clots to be detected in patient samples. Upon detection or aspiration of a clot, the left pipetting unit moves immediately to the left wash station and the pipetting needle is then primed/cleaned. The pipetting process of the right pipetting unit is ended for this determination. The system will automatically start the next determination. In the event of a positive clot detection, the sample is flagged in the **[Daily Lab-Journal]** as a machine error (*), the note "failed" appears next to the measuring result, and the sample must be manually restarted.

3.2.4 Incubator

The reaction modules filled with Patients and Reagents are incubated according to the assay requirements in the incubator at $36.8^{\circ}\text{C} \pm 0.5^{\circ}\text{C}$. The incubator has 10 receptacles for the reaction modules. Loading, incubation time are controlled via the software and dependent on assay type. Deviations in temperature are signaled on the monitor screen automatically via an icon.

Status and warning display on the monitor screen



The icon (thermometer symbol) is responsible for all temperature parameters of the system and thus also for the incubator temperature

This icon combines two functions:

a) Warning display with 'traffic light' function

The color of the thermometer on the icon changes according to status:

- Green** All temperature & voltage parameters are OK
Red One or more temperature or voltage parameters are outside the defined range. Press the icon and check which temperature is outside the specified range. Notify customer service.

b) Status display

The existing temperature and voltage parameters of the system are displayed in the [System Parameter] dialog box by pressing the icon.

Fig. 3.2.4-1: [System Parameter] dialog box



3.2.5 Washer

The reaction modules are washed in the washing system (washer) where excess reaction compound is aspirated. Three independently controlled injection pumps administer the wash liquid to three separate dispensing (injection) probes. All pumps operate with a constant volume of 400 μ l.

The three aspiration (suction) probes (located beside the dispensing probes) are connected to separate tubes, but all function from one common suction pump. If no reaction module or an empty one is under the aspiration probe, only air is aspirated.

During transport of the reaction modules in the washer, the probes are automatically lifted and lowered again for suction. Suction and lowering are synchronized to limit immersion and contamination of the probes. All dispensation and aspiration probes are mounted on a common lifting carriage (Washer lift).

The four height positions of the probes are:

1. Transport position

In this position, the suction needles are lifted only enough to allow free movement of the reaction module in the washer channel (one step to the next position).

2. Injection position:

In this position, the injection needles are dipped just below the surface of the reaction module where wash liquid is then dispensed.

3. Suction position:

In this position, the suction needles drop slowly to touch the base of the reaction modules while constantly aspirating.

4. Priming position:

In this position, the suction needles are located in the recesses (priming wells) of the washer transport channel where constant dispensing and aspiration take place simultaneously.

3.2.6 Measuring chamber

The chemiluminescence measurement is carried out in the measuring chamber with the aid of a highly sensitive photomultiplier.

The measuring chamber is sealed from all outside light influences. Outside the measuring chamber are two independently controlled injection pumps* for injection of the starter reagents. Each pump operates with a constant volume of 200 µl. The starter reagents are injected into the relevant cavity of the reaction module.

The geometrical arrangement of the injector ensures that with the injection of starter 1, the reagent is injected against the wall of the cavity of the reaction module. Starter 2 is injected straight into the cavity of the reaction module. This ensures optimum re-suspension of the magnetic particles and thus precise measurement of the light signal generated. After each individual measurement, the reaction solution is drawn off by suction. After the entire reaction module has completed the measuring process, it is further transported to the waste bag.

3.2.7 Pump systems

The MAGLUMI®600/800 Analyzer is provided with a series of independently operating pump systems, which are needed for the highly precise requirements of pipetting, washing and suction.

One section of the pump systems is located on the right side of the system between starter reagent container and reagent area and is inaccessible to the user:

- 1 Bypass pump for washing and priming the pipetting needle.
- 3 Injection pumps for the washer.
- 2 Injection pumps* for measuring chamber injectors.

The second pump section is located in the rear right of the analyzer, above and beside the measuring chamber and is also inaccessible to the user:

- 1 Suction pump for the washer.
- 1 dilutor unit for the pipetting units.
- 1 Suction pump for the measuring chamber.
- 1 Suction pump for the washing station of the pipetting unit.

NOTE

The maintenance on these pumps can only be performed by authorized persons and in accordance to the maintenance handbook.

3.2.8 Cuvette Loader

The cuvette loader is located to the far left of the analyzer. It is used for the storage of reaction modules ,approximately 30 reaction modules at one time.

NOTE

MAGLUMI 600 does not include the Cuvette Loader.

Loading reaction modules

The loading station for reaction modules is on the left front side of the analyzer (see Fig. 3.2.8-1).

The reaction modules are placed in and set at right angles to the transport direction on the stationary conveyor belt. A sensor detects the presence of reaction modules and immediately moves the belt to transport the reaction modules into the stacker. As soon as the conveyor belt stops, the next set of reaction modules may be loaded.

CAUTION

The Cuvette Loader should be emptied once a month to ensure uniform quality of the reaction modules.

Fig. 3.2.8-1: Loading with reaction modules on Maglumi 800



3.2.9 Starter reagents

The reagent reservoir contains the starter reagents (MAGLUMI® Starter Kit) and is located on the right side of the analyzer. The various positions are marked S1, S2. The numbers “1” and “2” refer respectively to starters 1 and 2. A level sensor implemented in the reagent cap monitors the liquid level of the starter reagents. Exchanging the starter reagents will then require flushing with the **<System Test>** button in the main menu in order to fill the feed tubes with reagents (see chapter 13). Due to the fact that the starter reagents are light sensitive, the reagent container must always be covered by the provided removable cover.

Fig. 3.2.9-1: Starter reagent container on the right side of the analyzer.



Do not spill liquid in this area!

Status and warning display on the monitor screen



The icon (system reservoir symbol) is responsible for all reservoir parameters of the system and thus also for the starter reagent volume.

This icon combines two functions:

a) Warning display with 'traffic light' function

Green Starters reagents are $\geq 20\%$

Yellow Starters reagents are $< 20\%$. Approximately 20 minutes after turning yellow. The processing of all reaction modules currently taking place is completed. The icon will become **Red**. And the pipetting of new samples is stopped or a cycle is not started if there is no more starter reagent left

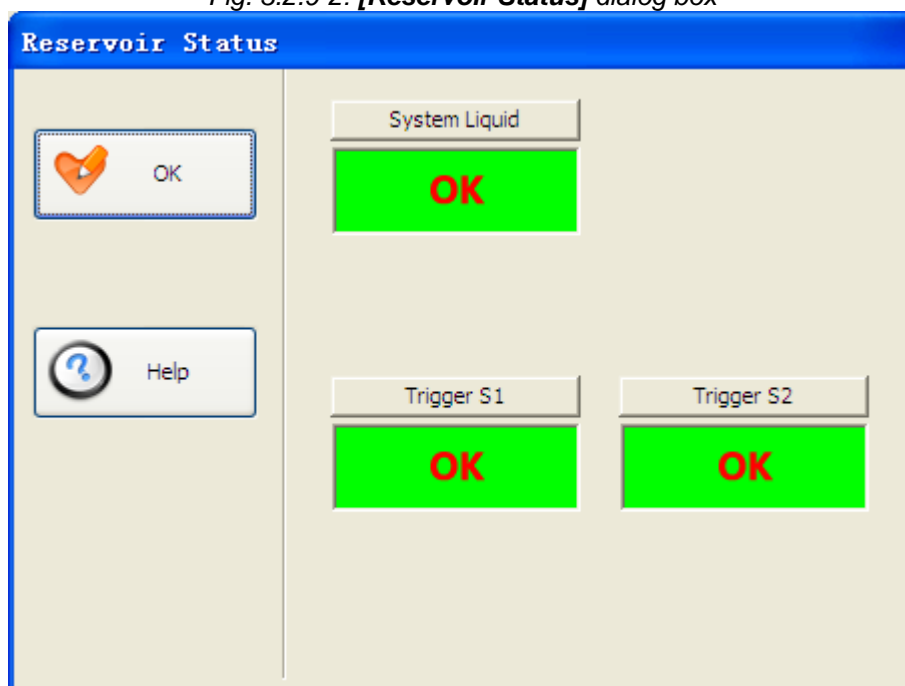
NOTE

In each case, press the icon to check which reservoir is running out and take countermeasures. There is no loss of either reagent or data when the analyzer is stopped by a system reservoir running out

b) Status display

When the icon is pressed, the dialog box **[Status Reservoir]** shows the reservoir of liquids..

Fig. 3.2.9-2: **[Reservoir Status]** dialog box

**Exchanging starter reagents**

Please refer to chapter 8 for detailed information.



Danger of chemical burns! Please read the instructions for use (IFU) concerning the starter reagents

Starter reagent consumption

200 μl per starter reagent per test, i.e. 2 x 200 μl .

3.2.10 Supply connections for wash / system liquid

The supply connections for wash / system liquid (MAGLUMI® Wash / System Liquid) are on the right side of the analyzer.

[System Liquid] for cleaning the pipetting needles and flushing the tubing system.

[Washing Solution] for washing the reaction module cavities.

The connecting sockets for the volumetric measuring instruments are also located here. The tube connections and cables go to the relevant canister covers. These together with the tubes and cables for the volumetric sensor, form a single unit.

To exchange the liquid, exchange the container or fill up with the relevant liquid.

Then start the flushing process from the main menu or by means of the **<System Test>** button to fill the tubes with liquid.

Fig. 3.2.10-1: drainage tubes for waste liquid on the right side of the analyzer.



The tubes are connected to the equipment with a tube coupling. Pressing the metal lever down opens the coupling to enable the tube to be removed.

Status and warning display on the monitor screen



The volume status of the wash / system liquid is displayed on the monitor screen by means of the system reservoir icon (reaction modules symbol).

This icon combines two functions:

a) Warning display with 'traffic light' function

Green wash / system liquid are $\geq 20\%$

Yellow wash / system liquid are $< 20\%$.Approximately 20 minutes after turning yellow. The processing of all reaction modules currently taking place is completed. The icon will become **Red**.And the pipetting of new samples is stopped or a cycle is not started if there is no more wash / system liquid left

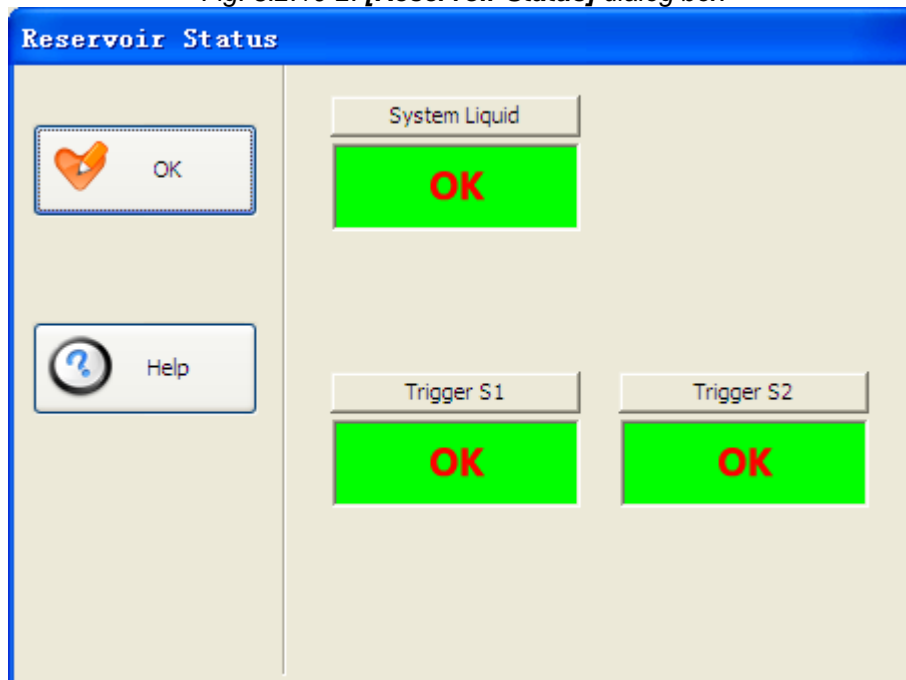
NOTE

In each case, press the icon to check which reservoir is running out and take countermeasures. There is no loss of either reagent or data when the analyzer is stopped by a system reservoir running out

b) Status display

When the icon is pressed, the dialog box **[Reservoir Status]** shows the reservoir of liquids..

Fig. 3.2.10-2: **[Reservoir Status]** dialog box



Exchanging wash / system liquid

Please refer to chapter 8 for this information: Supply with reaction modules and system liquids.

CAUTION

Please comply with the storage and manufacturer's directions included in the instructions for use (IFU) for the wash /system liquid (MAGLUMI® Wash /System Liquid).

3.2.11 Disposal

Reaction modules

The holder for the waste bag (MAGLUMI® Waste Bag) for used reaction modules is located on the right side of the analyzer next to the measuring chamber.



It is essential to ensure that the waste bag fits correctly underneath the reaction module exit, otherwise there is a risk that the analyzer operation will be interrupted due to blockage of the next reaction module at the edge of the waste bag

When the waste bag is full, it must be removed from its holder, sealed with the supplied cover and disposed of.



During testing the reaction modules come into contact with potentially infectious material and therefore must be disposed of appropriately with the waste bag

Fig. 3.2.11-1: Disposal of reaction modules



Liquids

The supply connections for wash / system liquid along with the two drain connections for waste 1 and waste 2 for liquid waste are located on the right side of the analyzer.

Waste 1 (chemical waste) originates from the measuring chamber and contains magnetic particles and starter reagents.

Waste 2 (biological waste) originates from the pipetting system and from the washer and contains wash / system liquid and liquid from the reaction modules (patient samples, assay reagents).



Biological waste must be disposed of separately according to domestic regulations.
Ensure that protective gloves are worn!

Both waste canisters contain volume status monitoring devices. The waste material status can be called up on the monitor screen with the <Waste Status> icon.

Status and warning display on the monitor screen



The <Waste Status > icon (volume container symbol) is used to observe the volume status of the liquid waste containers.

This icon combines two functions:

a) Warning display with 'traffic light' function

Green Waste container is $\geq 80\%$ full

Yellow Waste container is between 80 – 90% full.

Red Waste container is between 90 – 100% full.

The processing of all reaction modules currently taking place is completed.

The pipetting of new samples is stopped or a cycle is not started if a waste container is full, i.e. the icon is red.

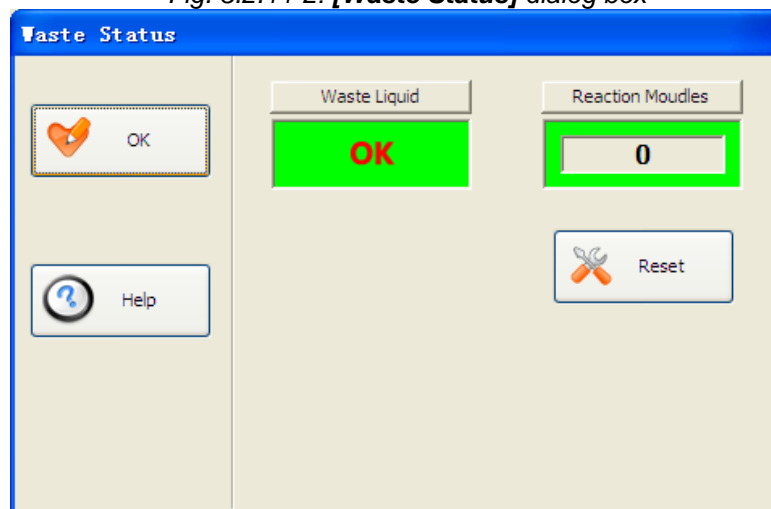
NOTE

After exchanging the waste bag, it is important to manually press the reset button in the [Status Waste] dialog box. Failure to do this can result in the postponing of jobs.

b) Status display

When the icon is pressed, the existing status of the waste container volume is shown in the [Waste Status] dialog box.

Fig. 3.2.11-2: [Waste Status] dialog box



3.2.12 Electrical and electronic connections

The connection to the serial interface (PC system), the power supply connection and the power switch are located on the left side of the analyzer.

Fig. 3.2.12-1: Electrical and electronic connections.



3.3 Computer system

Recommended requirements: Lenovo NETBOOK , including:

- Intel Pentium(R) Dual-Core CPU
- 160 GB hard drive or more
- 1G RAM or more
- Microsoft Windows 7

3.4 Software

- Windows 7
- Analyzer software V2.10 for control and operation of the analyzer.

3.5 Connecting cables

- 9 Pin RS232 Serial interface cable for NETBOOK → Analyzer
- 9 Pin RS232 Serial interface cable for NETBOOK → Host computer (**optional**)
- Power cord for MAGLUMI® 600/800 Analyzer

3.6 Consumables

Consumables with part numbers

- 1) Starter reagents (MAGLUMI[®] Starter Kit)
- 2) Wash / system liquid (MAGLUMI[®] Wash / System Liquid)
- 3) Reaction modules (MAGLUMI[®] Reaction Modules)
- 4) Reagent light check (MAGLUMI[®] Light Check)
- 5) Waste bag (MAGLUMI[®] Waste Bag)

3.7 Analyzer Performance

3.7.1 Measuring Chamber

Chamber	11/8 low-noise PMT, measuring wave-length range: 340nm~600nm
Light Sensitivity	<0.07pgATP
Measuring time	Interval : 0.1s~999s, for 1-20 optional intervals

3.7.2 Mean Time Between Failures ≥ 1000 h

3.7.3 Analyzer reproducibility

The intra-run LightCheck results are required : $CV \leq 10\%$.

3.7.4 Stability test

The inter-runs LightCheck results are required : $CV \leq 10\%$.

Chapter 4

Installation and Start up

4.1 Installation of the Equipment.....	2
4.1.1 Electrical connections of the system	3
4.1.2 Connecting supply containers for wash / system liquid and waste containers	4
4.1.3 Connecting starter reagents (MAGLUMI® Starter Kit).....	4
4.1.4 Fitting the waste bag for reaction modules (MAGLUMI® Waste Bag)	5
4.1.5 Loading reaction modules	5
4.2 Switching on and starting the system	6
4.2.1 Starting the PC(NETBOOK) system.....	6
4.2.2 Starting the system at the beginning of the work day	6
4.2.3 Starting the system at the beginning of the work week	6
4.2.4 Starting the system after a period of three or more days of inactivity	7
4.3 Starting the MAGLUMI® software & system	9
4.4 Shutting down the MAGLUMI® software & system.....	10
4.4.1 Shutting down at the end of the work day	10
4.4.2 Shutting down at the end of the work week.....	10
4.4.3 Shutting down for 3 or more days inactivity.....	10

4.1 Installation of the Equipment

The installation section of this chapter informs the user about all steps for user installation and start-up of the MAGLUMI[®]600/800 Analyzer. The original installation of the analyzer will be accomplished by a certified technician, trained in accordance with SNIBE regulations.

In this chapter, the user will be led step by step for all necessary installation processes to the setting up of the system.



For maintaining the safety of the user, the installation and start-up of the MAGLUMI Diagnostic System may only be performed by trained persons authorized by SNIBE.



The MAGLUMI Diagnostic System may only be installed and used under the working conditions (temperature, altitude, no direct sunlight exposure and humidity) defined in these Operating Instructions.

1、 Space and environment requirement :

Fig. 4.1-1 MAGLUMI[®]600



Fig. 4.1-1.2 MAGLUMI[®]800



A. Analyzer: L X W X H

Maglumi 600: L88cm x W 56cm x H50cm (including NETBOOK)

Maglumi 800: L102cm xW72cm x H56cm

The analyzer working area is required to be away from the walls of lab for more than 50cm.

The working area should be as long as 200 cm or more.

The working space should be as wide as 100 cm or more.

B. Environment: temperature 10-30 °C

Humidity ≤70%

(room aircondition is recommended)

2. Analyzer weight: 56kg(Maglumi 600)
73kg(Maglumi 800)

3. Power:

Voltage: a.c.110V -240V~

Frequency : 50Hz/60Hz;

Power input: 350VA (well grounding) for Maglumi 600.

630VA (well grounding) for Maglumi 800.

Fuse: FUSE 250V/3A;

Extra equipment: UPS 500V or above (strongly recommended)

4. Reagent and consumables :

Reagent : kits of 1-step assay and 2-step assay

Consumables: Wash/System liquid

Starter 1 and 2

Reaction Module

4.1.1 Electrical connections of the system

Arrangement of the equipment from left to right: PC(NETBOOK) – Analyzer

PC(NETBOOK) Connections

1. Install the supplied power cables to the PC(NETBOOK).
2. Connect the supplied RS232-USB cable to USB port of the PC(NETBOOK).

Analyzer Connections

1. Connect the remaining end of the RS232-USB cable to the analyzer RS232 port located on the left side of the analyzer beside the power switch.
2. Connect the supplied power cable to the analyzer.
3. Connect all power cables to the voltage supply.

4.1.2 Connecting supply containers for wash / system liquid and waste containers

The supply connections for wash / system liquid (MAGLUMI® Wash / System Liquid) are on the right inner side of the analyzer. The system liquid should be prepared in accordance with the delivered IFU (Instructions For Use).

Container Connections

1. Install the System liquid cap to the container marked "**System Liquid**"
2. Install the Waste cap to the liquid container marked "**Waste**"
3. Connect the two tubes of the system liquid cap to the analyzer connections marked "**System Liquid 1**". & "**System Liquid 2**".
4. Connect the two tubes of the waste liquid cap to the analyzer connections marked "**Waste Liquid 1**" & "**Waste Liquid 2**".
5. Insert the cable connectors of the system liquid cap into the receptacle marked "**System Liquid Sensor**".
6. Insert the cable connector of the waste liquid cap into the receptacle marked "**Waster Liquid Sensor**".

4.1.3 Connecting starter reagents (MAGLUMI® Starter Kit)

The reagent reservoir contains the starter reagents (MAGLUMI® Starter Kit) and is located on the right side of the analyzer.

Starter Reagent Connections

1. Remove the protection cover from the starter reagent reservoir.
2. Place the screw connection with the white tube labeled "S 1", on the bottle marked "**MAGLUMI® Starter 1**".
3. Place the screw connection with the white tube labeled "S 2", on the bottle marked "**MAGLUMI® Starter 2**".
4. Connect the sensor cable labeled "S 1" of the starter reagent reservoir to the pin on the cap of the bottle marked "**MAGLUMI® Starter 1**".
5. Connect the sensor cable labeled "S 2" of the starter reagent reservoir to the pin on the cap of the bottle marked "**MAGLUMI® Starter 2**".
6. Reinstall the cover for the starter reagent reservoir.

4.1.4 Fitting the waste bag for reaction modules (MAGLUMI® Waste Bag)

The holder for the waste bag (MAGLUMI® Waste Bag) for used reaction modules is located on the right side of the analyzer next to the measuring chamber.

Waste Bag Installation

1. Remove the cover of the waste bag support on the right side of the analyzer.
2. Install one of the supplied MAGLUMI® waste bags
3. Fit the waste bag with support and close it off with the support cover.



Ensure that the waste bag is correctly fitted in and underneath the holder; otherwise the analyzer may stop due to jamming of the following of reaction modules at the edge of the waste bag.

When the waste bag is full, it must be removed from the holder, sealed with the waste bag cover provided and disposed of according to local regulations.

4.1.5 Loading reaction modules

Reaction modules are plastic containers with 6 cavities each where the sample reaction occurs and is measured.

Reaction Module Installation

1. Open a pack of MAGLUMI® Modules as directed and remove a set (8 modules) of reaction modules from the pack.
2. Manually insert the cuvettes to the incubator located on the left side of analyzer. Make sure each cuvette should be inserted completely
3. The analyzer will automatically correct the cuvette position which is present in the incubator.
4. Repeat this process until the incubator is sufficiently full. Its maximum capacity is 10 reaction modules.

4.2 Switching on and starting the system

Before the system may be turned on, it is necessary to ensure that all steps in section 4.1.1 “**Electrical connections of the system**” have been completed.

There are several different processes when starting the MAGLUMI[®] system. The type of start is dependent on the amount of time the MAGLUMI[®] analyzer was shut down.

Types of start up

- Initial Starting the PC(NETBOOK) system
- Daily Starting the system on at the beginning of the work day
- Weekly Starting the system on at the beginning of the work week
- Prolonged Starting the system after a period of more than 2 days of inactivity

4.2.1 Starting the PC(NETBOOK) system

Turn on the PC(NETBOOK). Wait for the system to start (this is completed when the “Desktop” window appears).

4.2.2 Starting the system at the beginning of the work day

Upon starting the working day, the following steps should be completed:

1. Turn on the monitor.
2. Follow the “**Daily Maintenance Instructions**” found in chapter 18 (the maintenance may be accomplished either at the end or beginning of the working day).
3. Complete the “**System Test**” according to chapter 9.

4.2.3 Starting the system at the beginning of the work week

Upon starting the working week (consisting of no more than two consecutive days of inactivity), the following steps should be completed

1. Turn on the monitor.
2. Double click on the “**Maglumi User**” icon by using either the mouse or the touch screen.
3. Enter the user name & password in the [**Login**] dialog, and press <OK>. The software will start.(you can select check “ ✓ ” for the <**Initialization With Cuvette(s) Clear**> in the [**Login**] dialog , refer to section 8.2.1.)
4. Turn on the analyzer ,then the initialization will execute automatically . If you have select check “ ✓ ” for the <**Initialization With Cuvette(s) Clear**> in the [**Login**], The analyzer will begin to clear all working channels in the system to ensure no collisions occur during normal operation.

The system is ready when no further pop-ups appear on the monitor.

1. Insert all necessary integrals in the analyzer according chapter 14.
2. From the **[Main Menu]** select the icon **<System Test>**, and follow the instructions listed in chapter 9.

4.2.4 Starting the system after a period of three or more days of inactivity

Upon initiation of the working day whereas the analyzer was inactive for a period of three or more days (consisting also of prolonged weekends) the following steps should be completed:

1. Before the work session can be started:
 - a. Replace the tank of distilled H₂O with a tank of Wash/System Liquid; ensuring preparation is in accordance to chapter 13.2.2.1.
 - b. Replace the two starter reagent containers of distilled H₂O with two original starter reagent containers.
2. Turn on the PC(NETBOOK) & Monitor. Wait for the PC(NETBOOK) to start (this is completed when the "Desktop" window appears).
3. Double click on the "**Maglumi User**" icon by using either the mouse or the touch screen.
4. Enter the user name & password in the **[Login]** dialog, and press **<OK>**. The software will start.(you can select check " ✓ " for the **<Initialization With Cuvette(s) Clear>** in the **[Login]** dialog , refer to section 8.2.1.)
5. Turn on the analyzer ,then the initialization will execute automatically . If you have select check " ✓ " for the **<Initialization With Cuvette(s) Clear>** in the **[Login]**, The analyzer will begin to clear all working channels in the system to ensure no collisions occur during normal operation.
6. The system is ready when no further pop-ups appear on the monitor.Insert all necessary integrals in the analyzer according chapter 14
Execute "**System Test**" selecting the values listed in the Fig 4.2.4-1

Fig 4.2.4-1: Start up Priming Table (1st run)

Section	Type	Values
Cycles	Pipettor	3
	Washer	3
	Chamber Set A	3
Reaction modules	BGW	0
	LC	0

7. When the Priming has been completed, repeat the “**System Test**” in accordance to values listed in the Fig 4.2.4-2.

Fig 4.2.4-2: Start up Priming Table (2nd run)

Section	Type	Values
Cycles	Pipettor	0
	Washer	0
	Chamber Set A	0
Reaction modules	BGW	1
	LC - le	1

4.3 Starting the MAGLUMI® software & system

The normal icon for entering the MAGLUMI® software is located directly on the windows desktop.

When entering the software anytime the analyzer has been shut off, it must be ensured that the analyzer remains off until prompted to do so.

1. Double click on the icon in figure 4.4-1 by using either the mouse or the touch screen.

Fig 4.3-1: MAGLUMI® 600 software access example



2. Before the software can be accessed, a user name and password must be given. The user can change the software access to accept any name and password wished (see Chapter 6 section 6.4).

Fig. 4.3-2 User login

A screenshot of the 'Login' dialog box. The title bar is blue and contains the word 'Login' in white. The main area has a light beige background. On the left, there are two buttons: 'OK' with a key icon and 'Help' with a question mark icon. On the right, there are two text input fields: 'User' and 'Password'. At the bottom, there is a checkbox labeled 'Initialization With Cuvette(s) Clear'.

3. Enter the user name & password. The software will start.
4. When the message "**No connection to device**" appears, turn on the analyzer and wait until the LED's of all free tracks in the patient area have changed from red to green.
5. **Afterwards** press <OK>. The analyzer will begin to clear all working channels in the system to ensure no collisions occur during normal operation.

The system is ready when no further pop-ups appear on the monitor.

4.4 Shutting down the MAGLUMI® software & system

There are several different processes when shutting down the MAGLUMI® software & system. The type of shut down preparation is dependent on the future usage of the MAGLUMI® analyzer.

Types of shut down

- Daily Shutting down for the end of the work day
- Weekly Shutting down for the end of the work week
- Prolonged Shutting down for 3 or more days of inactivity


4.4.1 Shutting down at the end of the work day

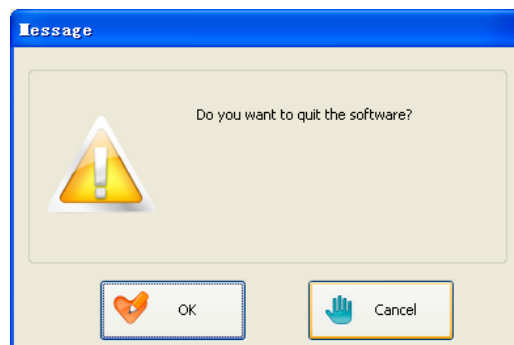
Upon completion of the working day, the following steps should be completed:

1. Turn off the monitor.
2. Follow the “**Daily Maintenance Instructions**” found in chapter 18 (the maintenance may be accomplished either at the end or beginning of the working day).

4.4.2 Shutting down at the end of the work week

Upon completion of the working week (consisting of no more than two consecutive days), the following steps should be completed;

1. Select the icon  at the right bottom of the main menu, a message box will appear in the middle of the **[Main Menu]**.
2. The message box appears as shown below.



3. Select the icon  and the software will be closed.

4. Turn off the monitor.

4.4.3 Shutting down for 3 or more days inactivity

Upon completion of the working day whereas the analyzer will be inactive for a period of more than two days (consisting also of prolonged weekends) the following steps should be completed:

It is possible to carry out this procedure for short periods of inactivity too (for example, during weekends).

1. When the work session is finished:
 - a. Rinse and fill two empty starter reagent bottles with distilled H₂O, preferably at 35° - 40°C.
 - b. Replace the starter reagents bottles with the two bottles of distilled H₂O.
 - c. Replace the Wash/System Liquid tank with a tank of distilled H₂O.
 - d. Execute "**System Test**" selecting the values at least equal to the following (see Fig 4.4.3-1):

Fig 4.4.3-1: Decontamination Priming Table

Section	Type	Values
Cycles	Pipettor	3
	Washer	3
	Chamber Set A	3
Reaction modules	BGW	0
	LC	0

2. Follow the normal shutting down procedure (see section 4.4.2).

Chapter 5

Operation and Structure of the Software

5.1 Operating the software	2
5.2 Structure of the software / main menu	3
5.3 Menu items in overview	10

5.1 Operating the software

The analyzer software has a clearly presented structure, which simplifies operation with visual and functional aids. The software can be operated with mouse and keyboard.

Mouse operation

The usual conventions of mouse operation are supported.

- Click to select a function or option.
- Double click to select a file and load it.
- Drag to select an entry or range.

Text is entered via the keyboard after the desired entry field is activated.

Keyboard operation

Operation of the software from the keyboard supports operation via the touch-screen monitor and the mouse.

Alphanumeric entries are always made via the keyboard.

Select the desired function in the dialog boxes by pressing the **<Tab>** key repeatedly until the desired option or button is selected. Then actuate the function by pressing the **<Enter>** key. The entry fields are also actuated in the same way. When text is already entered in an entry field and activated by pressing the **<Tab>** key, the text is simultaneously selected and can be deleted by pressing the **** key.

5.2 Structure of the software / main menu

Three levels can be distinguished in the analyzer software: The **main menu**, which displays the system status and from which all functions can be selected, the **loading dialogs** for loading samples and reagents, and the **dialog boxes** for defining parameters.

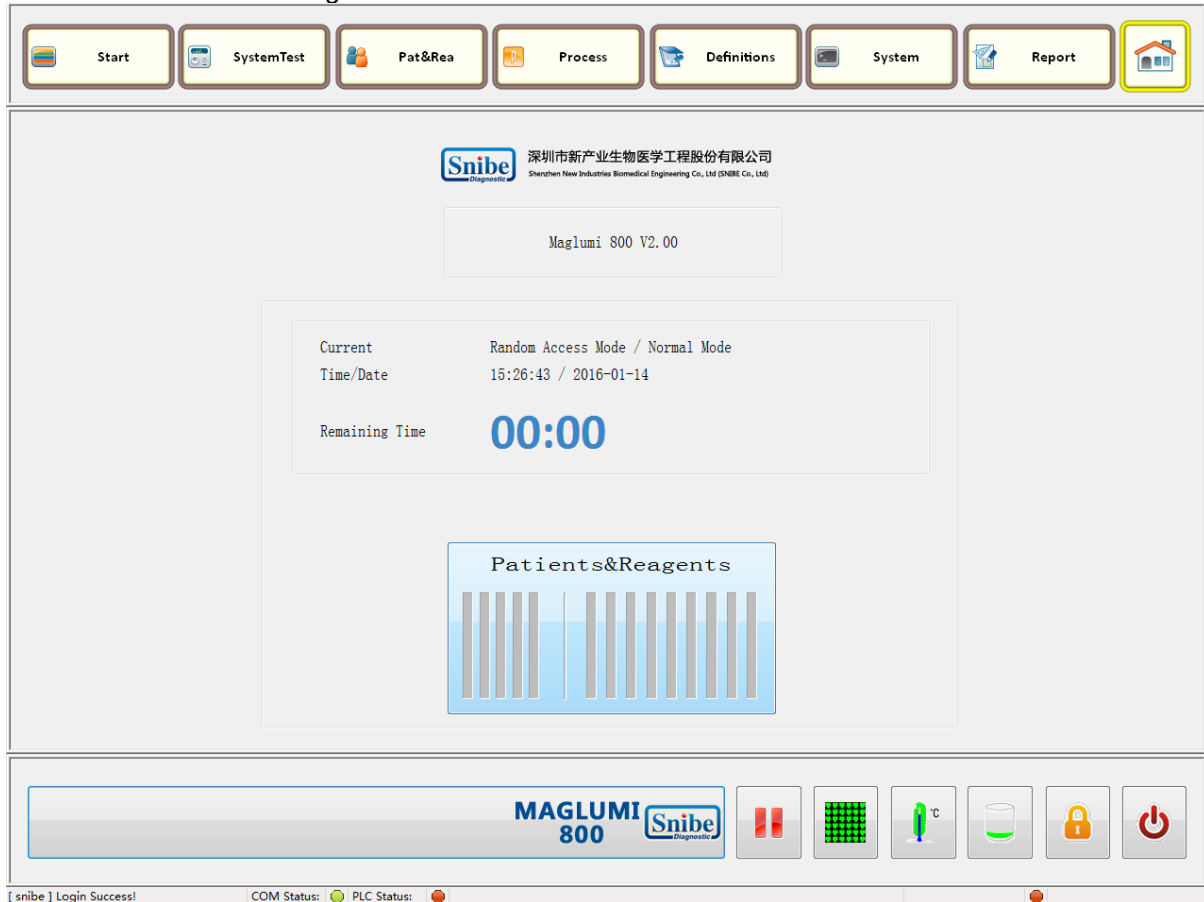
Main menu

In the main menu, the depicted functions of the analyzer are shown schematically.

Fig. 5.2-1: The main menu of the MAGLUMI® 600 software



Fig. 5.2-2: The main menu of the MAGLUMI® 800 software



There are nine buttons at the top of the screen that lead to the individual menus.

On the bottom-right of the [Main Menu] screen there are six icons.



<STOP> is for emergency stop of the analyzer.



<Reservoir Status >indicates the status of the starters and system liquid.



<System Parameter> indicates the temperature of each part of the analyzer.



<Waste Status> indicates the status of waste liquid and reaction modules.



<User Lock> used for locking the software.



<EXIT> used for exiting the software.

The existing status of the analyzer is portrayed by the symbols on the icons and the colors green, yellow and red as well as the symbolic displays indicating full, almost empty, and empty.

On the bottom-left of the screen is a button to open the list of system and error messages [Message Box]

LOADING DIALOGS

<Patients and Reagents> is icon that simultaneously provide on board information.

Patient dialog color identification viewed from the **[Main Menu]**. The sample station loading is displayed via the **<Patients and Reagents >** icon. The sample racks inserted are color-coded at two different levels **[Main Menu]** & **[Patient and Reagent]** dialog. The colors below describe the view only from the **[Main Menu]**.

- Red** The sample rack has not been correctly recognized on insertion.
- Green** The sample rack has been correctly recognized on insertion.

Reagent dialog color identification viewed from the **[Main Menu]**. The reagent station loading is displayed via the **< Patients and Reagents>** icon. The Reagent Integrals inserted are color-coded only at the **[Main Menu]** level.

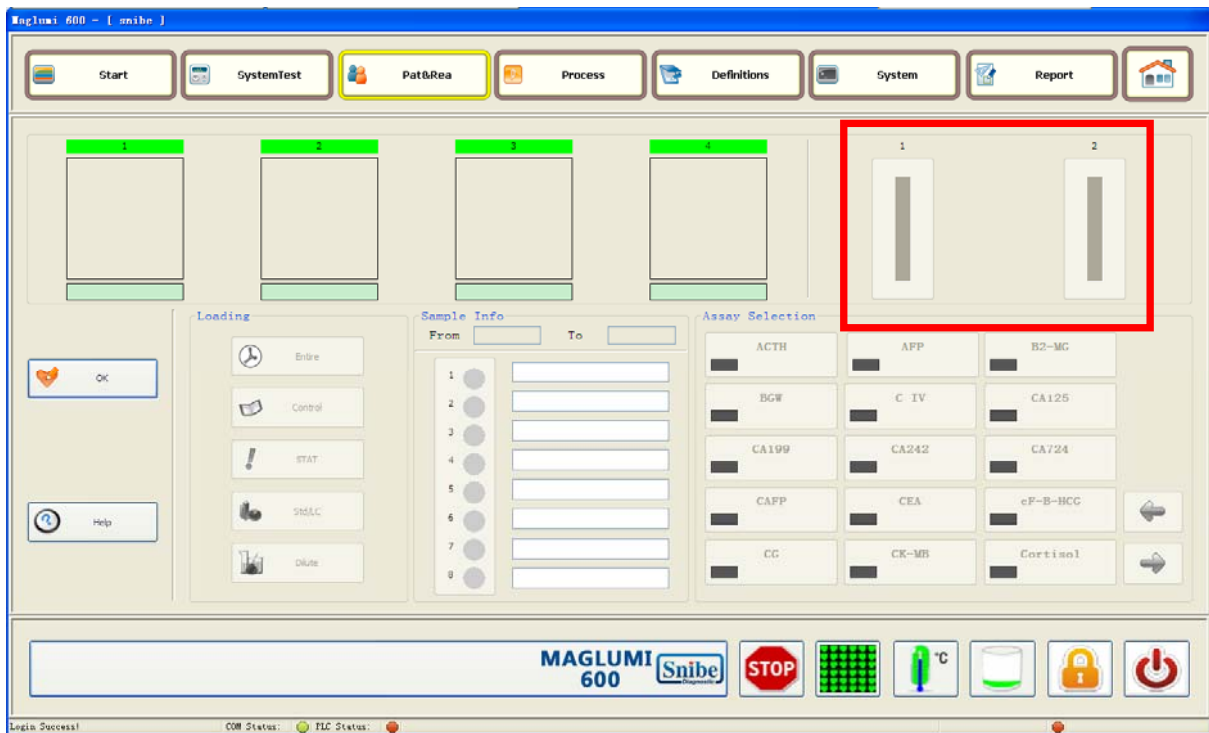
- Red** The Reagent Integral has not been correctly recognized upon insertion.
- Yellow** The Reagent Integral has been correctly recognized upon insertion. It has no valid calibration or it is using a calibration from another integral (shared working curve).
- Green** This Reagent Integral has been correctly recognized on insertion and has a valid calibration.
- Purple** This Reagent Integral has been correctly recognized on insertion and has a expired calibration.
- Black** This Reagent Integral has been correctly recognized on insertion and has a expired kit integral.

The analyzer interactive button is the **<Patients & Reagents>** Icon in the main menu. Opening the door activates the pertaining screen in the software.

[Sample loading] section

Opening the cover of the Sample loading station or by pressing the **<Patients & Reagents >** button in the main menu opens the **[Sample and Reagent loading]** dialog.

Fig. 5.2-3: Sample loading Section



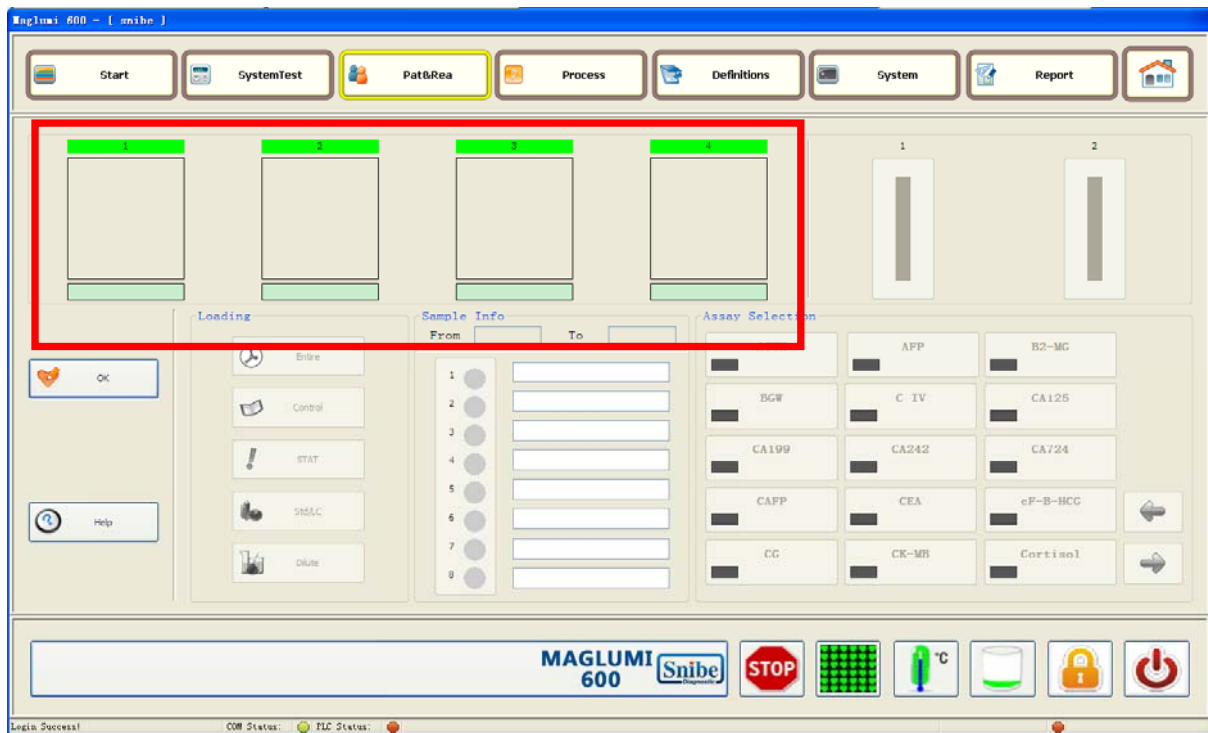
- Red** The sample rack has not been correctly recognized upon insertion.
- Green** The sample rack has been correctly recognized upon insertion.
- Blue** The sample rack has been correctly recognized upon insertion and has been selected.

The tracks of the sample racks are shown schematically in the sample loading dialog and the existing load is displayed. There is a button for each track occupied and each patient sample, which is actuated when selected. This enables each individual sample to be processed.

[Reagent loading] section

Opening the cover of the reagent loading station or by pressing the **< Patients & Reagents >** button in the main menu opens the [Reagent-loading] section.

Fig. 5.2-4: Reagent loading Section



Gray (+ name) The integral rack has been correctly recognized upon insertion.

Gray (+ Error) The integral rack has not been correctly recognized upon insertion.

Dark Gray(+ name) The integral rack has been correctly recognized upon insertion and has been selected.

Dark Gray(+ Error) The integral rack has not been correctly recognized upon insertion and has been selected.

The tracks of the Reagent Integrals are shown schematically in the reagent loading dialog and the existing load is displayed. Each track occupied, i.e. each Reagent Integral, represents its own actuating button and can be processed by this means.

DIALOG BOXES

Pressing a button always leads to a dialog for the definition of detailed information. The dialog can cover one or more dialog boxes.

Two types of dialog box can be differentiated:

- a) Dialog boxes for parameter definition

Here for example, assays are selected, controls selected, data entered etc. They have entry fields, option fields, control fields, list fields and buttons etc.

Fig. 5.2-5: Example of a dialog box for parameter definition.

The screenshot shows a software dialog box titled "User Specific Assay Data". It is divided into several functional areas:

- Left Panel:** A vertical stack of buttons: "Save" (with a heart icon), "Cancel" (with a hand icon), "Help" (with a question mark icon), "MasterCurve" (with a graph icon), "Qualit.Ibl" (with a red bar icon), and "Format" (with a green bar icon).
- Main Content Area:**
 - Name:** "Adrenocorticotrophic Hormone" and "055"
 - Abbreviation:** "ACTH" and "Snibe"
 - Unit:** "pg/mL" x "1" = "pg/mL"
 - Samples:** "Replication" set to "1"
 - Calibration:** "Replication" set to "2", "Calibrate" set to "15" days
 - Normal Range:** "6" ... "80"
 - Assay Range:** "0.2" ... "2000"
 - Reflex Range 1:** "0" ... "0"
 - Reflex Range 2:** "0" ... "0"
 - Controls:** An "Active" checkbox and a table with columns "Name" and "Lot-No".
 - Determinations:** A group of checkboxes: "Every", "Batch begin", "End of batch", "After Calibra", "With STATs", "Determinations", and "Hours".
- Right Panel:** Three buttons: "AutoDil.", "Reflex 1", and "Reflex 2", each with a red bar below it.

- b) Dialog boxes which have only buttons

Some dialogs are so extensive that they have additional branching. For example, after pressing the **<Definitions>** button in the main menu, the **[Definition]** dialog box appears, which has only buttons that lead to additional dialogs.










Fig. 5.2-6: Example of a dialog box with buttons.



5.3 Menu items in overview

The following menus and functions can be selected in the main menu:

Buttons for program operation

 Start	<Start>	Starting a run(measurement of patient samples or controls)
 SystemTest	<System Test>	System test functions e.g. flush tube system and carry out internal test measurements.
 Process	<Process>	Process functions e.g. automatic clearance of the reaction modules.
 Definitions	<Definitions>	User settings of assays, controls, dilutions, assay groups and assay profiles, sample senders.
 System	<System>	Displays system parameters as well as selection of operating modes.
 Report	<Report>	Result management (output of the results and validation possibilities).
	<STOP>	Stopping a run.
	<Home>	Return to the main menu.
 Pat&Rea	<Pat&Rea>	Patient information

Chapter 6

Menu [System] in detail

6.1 Menu [System] in overview	2
6.2 System Functions [Info] in detail	3
6.3 System Functions [Mode] in detail.....	4
6.4 System Functions [User] in detail	6
6.5 System Functions [Language] in detail	8
6.6 System Functions [Wash Pipe] in detail.....	8
6.7 Exiting the MAGLUMI® program	9

6.1 Menu [System] in overview


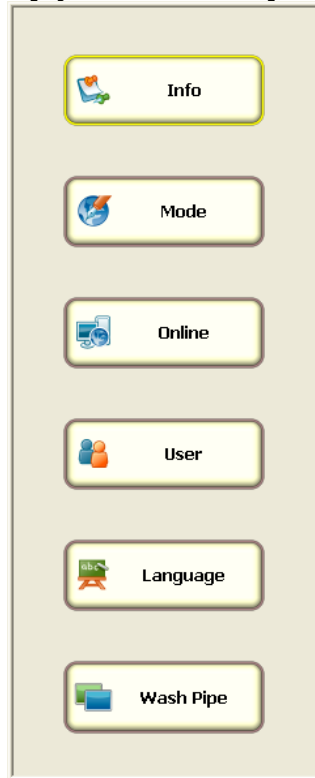
A series of functions is available for setting-up and testing the software which appears in the **[System Functions]** dialog box when pressing the  button in the main menu.

Fig. 6.1: **[System Functions]** dialog box



- <Info> Containing System information
- <Mode> Selection of operating mode
- <Online> Basic setting for connection to a host computer
- <User> User management
- <Language> Chinese, English and Spanish operation interfaces are available.
- <Wash Pipe> Washing the pipeline of the system.

6.2 System Functions [Info] in detail


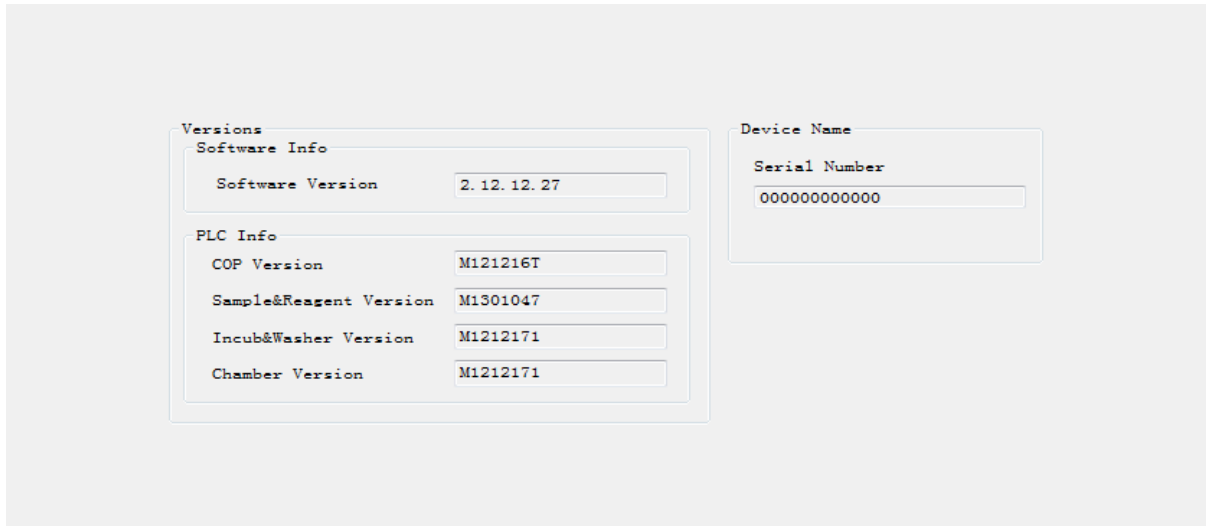
Selecting the  button in the **[System Functions]** dialog box opens the **[System Information]** dialog box.

Fig. 6.2-1: **[System Information]** dialog box



The dialog box contains the version numbers under **[Versions]** for:

[Software Info] area:

- **[Software Version]**

[PLC info] area:

- **[COP Version]** the communications processor
- **[Sample&Reagent Version]**
- **[Incubator & Washer Version]**
- **[Chamber Version]**

[Device Name] area:

- **[Serial Number]** = Manufacturer production number

6.3 System Functions [Mode] in detail


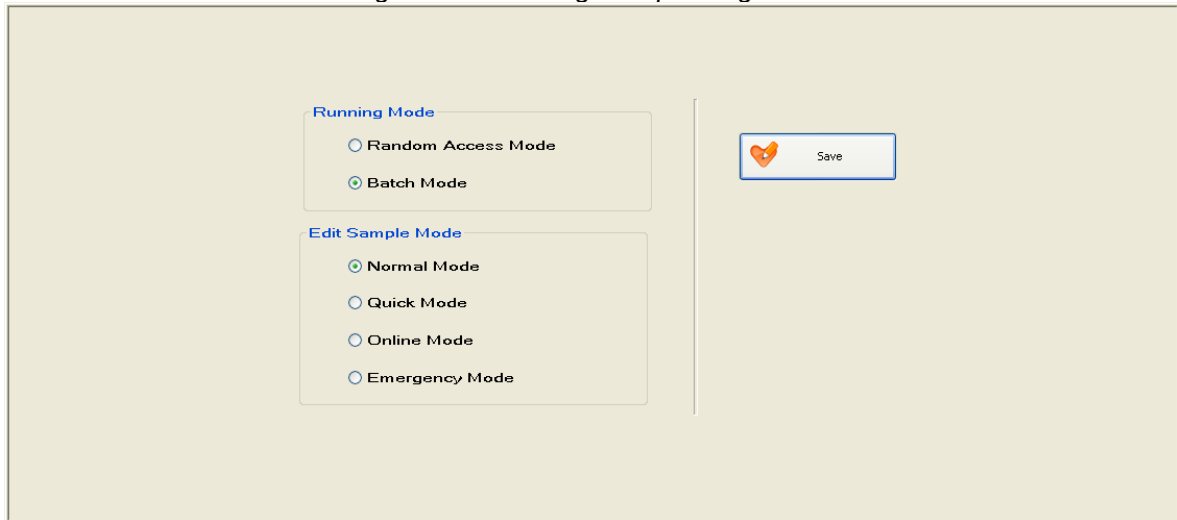
1. Press the  button in the [System Functions] dialog box.
2. The [System Mode Selection] dialog box appears.
3. Select the mode you require. This is marked with a green diamond.
4. Confirm the entry with <Save >. The mode selected is notified to the system and set.

Fig. 6.3-1: Selecting the operating mode.



a) Running Mode:

[Random access]

In Random Access mode all tests are scheduled “by Rack”, i.e. the scheduler tries to process all tests within a rack first before continuing with the next rack. The tests are prioritized in the following order:

- a. STAT priority
- b. Auto Reflex- and Auto Dilution jobs
- c. Sample rack position (track number from left to right)
- d. Incubation time (longest first)
- e. Assay abbreviation (alphabetically, A-Z)
- f. Sample tube position within rack

Advantage: Fastest possible processing of an individual sample rack. (Quicker rack release)

Use: This operating mode is used when many different tests are processed or many different senders require fast results.

[Batch]

In Batch mode all tests are scheduled “by Bay” (the entire patient area), i.e. the scheduler optimizes throughput using all tests in the complete patient area. The tests are prioritized in the following order;

- a. STAT priority
- b. Auto Reflex- and Auto Dilution jobs
- c. Assay abbreviation (alphabetically, A-Z)
- d. Incubation time (longest first)
- e. Sample tube position (from left to right, within rack from back to front)

Advantage: Best possible utilization of the reaction modules and high throughput.

Use: This operating mode is used when only a few different tests are processed with a high sample throughput.

b) **Edit Sample Mode:**

[Normal]

Read ID of sample from barcode and manually enter assay entry

[Quick]

Generate ID of sample by software and manually enter assay entry

[Online]

Get information of the sample from Network (the information includes sample ID , patients' data , etc)

[Emergency]

To enable the analyzer work without the function of sample&reagent flap and barcode reader.

6.4 System Functions [User] in detail

User management

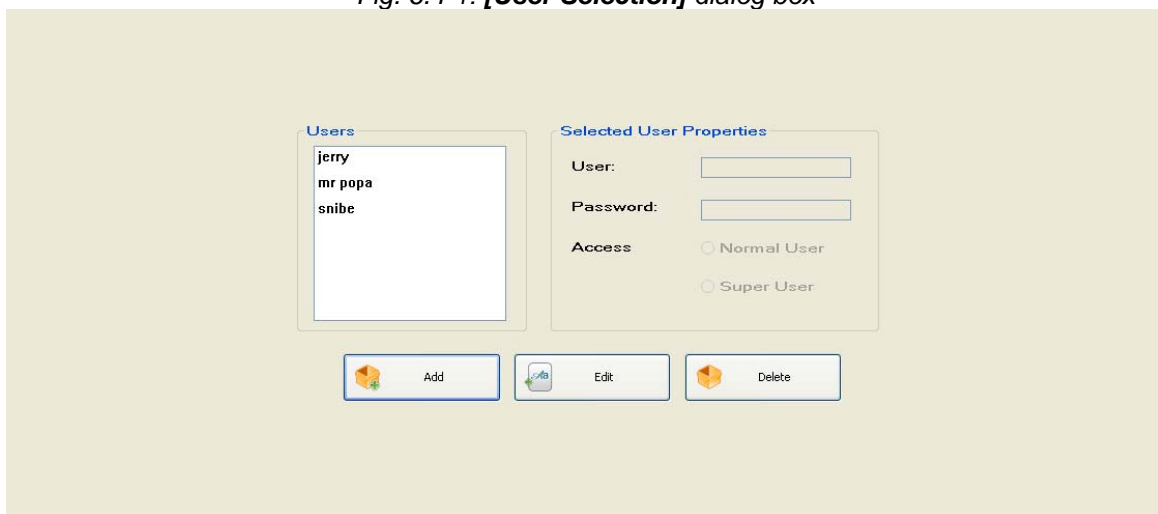
The software provides a user management system, which allows authorized system managers to create and assign certain access rights to users. The user data can be edited.

Select the **<System>** button in the main menu and press the



button in the **[System Functions]** dialog box. The **[User Selection]** dialog box then appears.

Fig. 6.4-1: **[User Selection]** dialog box



[Users]

Showing a list of users entered that are available.

[Selected User Properties]

Displaying the access data of the user selected in the **[User]** list.

<Add>

Adding users.

<Edit>

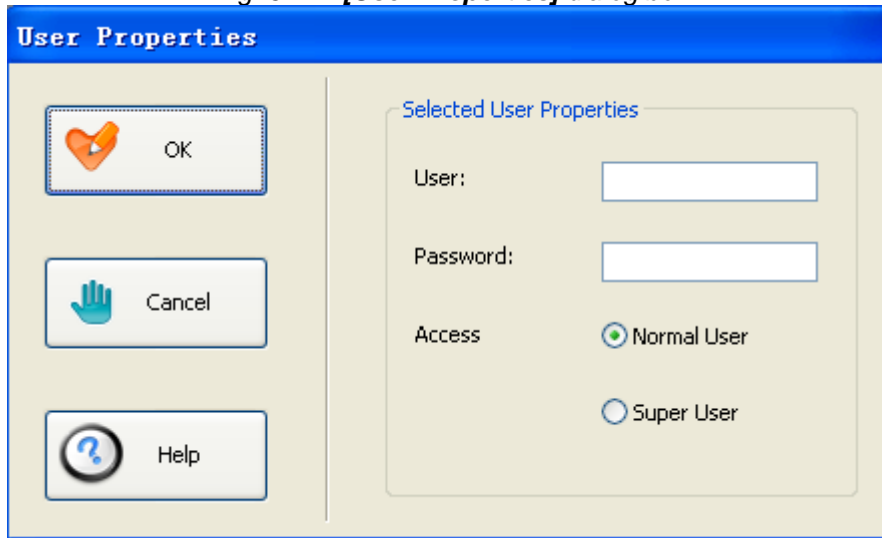
Editing the selected users data.

<Delete>

Removing users.

When **<Add>** is selected, the **[User properties]** dialog box appears for entry of the user data.

Fig. 6.4-2: [User Properties] dialog box



[User] Name of the future user. This forms part of the future password for this user.

[Password] Password

[Access] Rights of the user. The Super User obtain all the functions ,whlie some functions are inaccessible to the Normal User

The new user data is saved with **<OK>**.

<Cancel> returning the program to the **[User Properties]** dialog box without saving.

<Edit> Selecting a user from the **[User]** list in the **[User Properties]** dialog box. Pressing **<Edit>** produces the **[User Properties]** dialog box, in which the data of the user can be corrected (see Fig. 6.2-2).

Save the corrected user data with **<OK>**.

<Cancel> returning to the **[User Properties]** dialog box without saving.

<Delete> Selecting a user from the **[User]** list in the **[User Properties]** dialog box. The user is deleted from the list by pressing **<Delete>** and then confirming with **<OK>**.

Quit the **[User Properties]** with **<OK>**.

6.5 System Functions [Language] in detail

Language setting

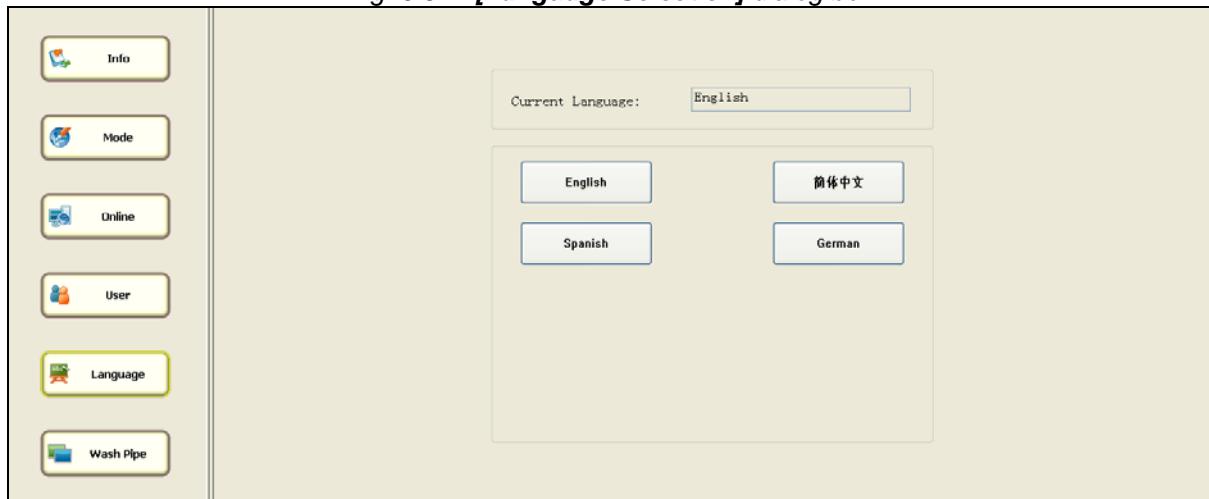
The software provides language versions for selection

Select the **<System>** button in the main menu and press the



button in the **[System Functions]** dialog box. The language setting dialog box then appears.

Fig. 6.5-1: **[Language Selection]** dialog box



6.6 System Functions [Wash Pipe] in detail

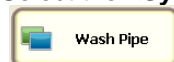
The MAGLUMI System tubing cleaning solution is useful to minimize reagent carryover by reducing protein in the tubing, and improve routine maintenance of the MAGLUMI system. It intervenes to clean the pipettor and the washer needles with cleaning program.

Insert the empty reagent integral filled with MAGLUMI System tubing cleaning solution integrally in the reagent area track 1.

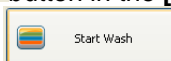
NOTE

Please read the IFU of the MAGLUMI System tubing cleaning solution to understand how to prepare the reagent integral before using.

Select the **<System>** button in the main menu and press the



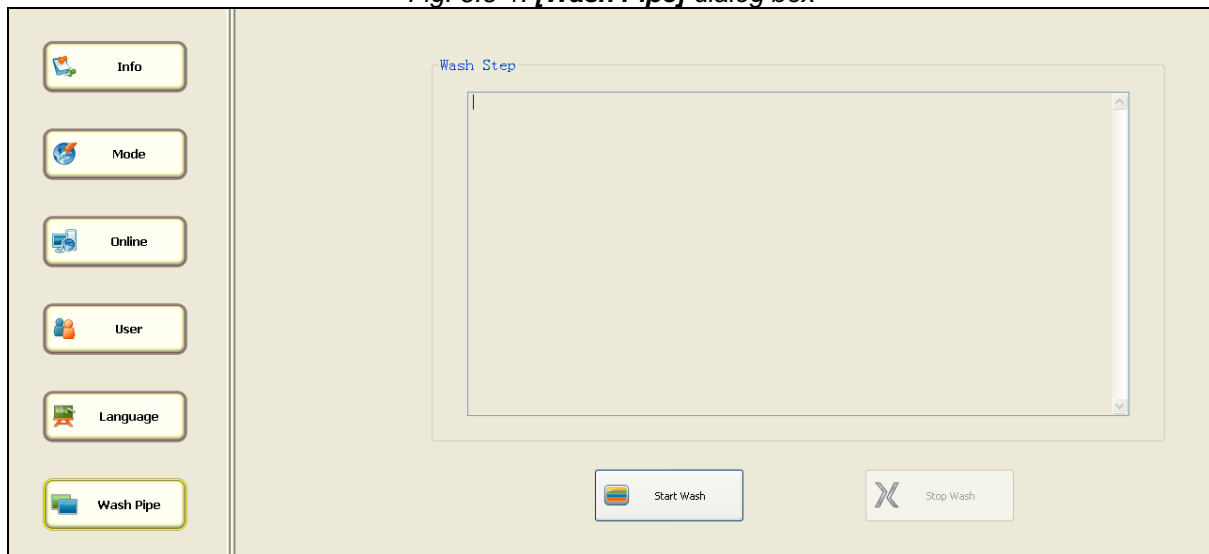
button in the **[System Functions]** dialog box.



Then click the button to start the washing procedure.

Note: Do not conduce emergency stop during the washing process is runing.

Fig. 6.6-1: [Wash Pipe] dialog box



6.7 Exiting the MAGLUMI® program


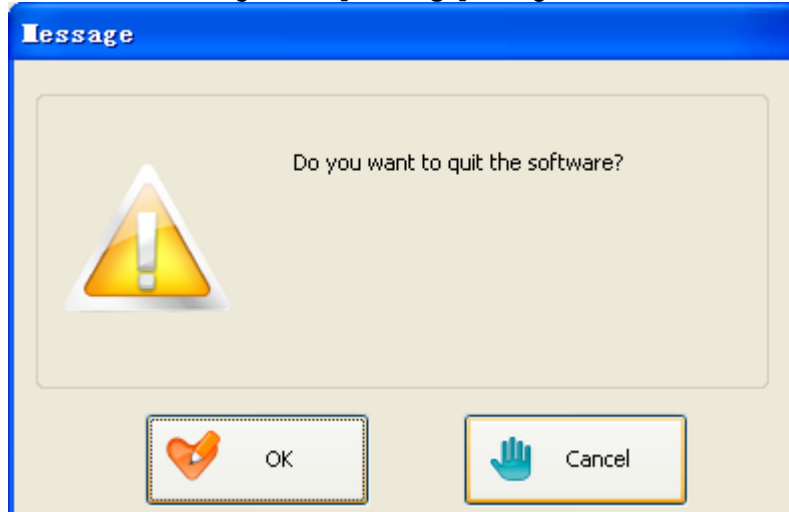
Press the exit button  in the right bottom of the main menu and a message box will appear.
Select the <OK> to exit the MAGLUMI® software.

Fig. 6.7-1: [Message] dialog box




Chapter 7

Menu [Definitions] in detail

7.1 Definitions in overview	3
7.2 <Test> icon in detail	4
7.2.1 [Assay Selection] icon, <Export> in detail	5
7.2.2 [Assay Selection] icon, <Import> in detail	5
7.2.3 [Assay Selection] icon, <TEST> in detail	7
7.2.4 [Assay Selection] icon, <Edit> in detail	7
7.2.4.1 [User Specific Assay Data] – Saving and Canceling	9
7.2.4.2 [User Specific Assay Data] – Information section	9
7.2.4.3 [User Specific Assay Data] – range settings	10
7.2.4.4 [User Specific Assay Data] – automatic retesting	11
7.3 <Control> icon in detail	19
7.3.1 [Control Selection] icon, <Add> & <Edit> in detail	20
7.3.1.1 [Control Data Input] – Saving and Canceling	20
7.3.1.2 [Control Data Input] – control specification	21
7.3.1.3 [Control Data Input] – Selection of the assay	21
7.3.1.4 [Control Data Input] – Control detailed descriptions	22
7.3.1.5 [Control Data Input] – Procedure for adding a control	25
7.3.2 [Control Selection] icon, <Delete> in detail	26
7.4 <Group> icon in detail	27
7.4.1 [Group Selection] icon, <Add>, <Insert>, <Edit> & <Copy> in detail	28
7.4.1.1 [Group Selection] – saving and canceling	28
7.4.1.2 [Group Selection] – [Selected Assay]	28
7.4.1.3 [Group Selection] – Assay Selection	29
7.4.1.4 [Group Selection] – [Assay Group]	30
7.4.1.5 [Group Selection] – Procedure for assigning an assay to an existing group	31
7.4.1.6 [Group Selection] – Procedure for assigning a new group to the database	31
7.4.1.7 [Group Selection] – Procedure for inserting a new group to the database	33
7.4.1.8 [Group Selection] – Procedure for copying an existing group to the database	33
7.4.2 [Group Selection] icon, <Delete> in detail	34
7.5 <Sender> icon in detail	35
7.5.1 [Sender Selection] icon, <Add>, <Edit>, & <Copy> in detail	36
7.5.2 [Sender Selection] icon, <Delete> in detail	37
7.6 <Dilut.> Icon in detail	39
7.6.1 [Dilution] – Saving and Canceling	40
7.6.2 [Dilution] – Assay	40
7.6.3 [Dilution] – Assay Selection	40
7.6.4 [Dilution] – Dilution Selection	41
7.6.5 [Dilution] – Selected Dilutions	42

7.6.5.1 [Selected Dilutions] - <Edit> in detail -----	42
7.6.5.2 [Selected Dilution] - <Delete> in detail-----	43
7.6.6 <Dilute> How to set a dilution -----	45


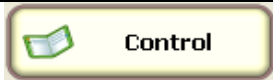



7.1 Definitions in overview

By pressing the  button from the main menu it is possible to access certain test to alter some settings. This section describes which settings can be altered and the proper process in doing so.

When the **<Definitions>** button is pressed from the main menu, the **[Definition Functions]** area appears on the left of the monitor (see Fig. 7.1-1 Definition Functions).

Fig. 7.1-1: Definition Functions



	Access button for specific assay settings.	7.2 <Test> icon in detail
	Selection, modification, or insertion of a control	7.3 <Control> icon in detail
	Allows a user to create a selection page for the patient dialog.	7.4 <Group> icon in detail
	Allows the user to enter an origin(sender) of received samples.	7.5<Sender> icon in detail
	Allows the user to set self defined dilutions.	7.6 <Diluter> icon in detail

7.2 <Test> icon in detail

Access levels:

All user levels may view tests but editing access is restricted. See user access table.

Select **<Definitions>** in the main menu to bring up the **[Definition**


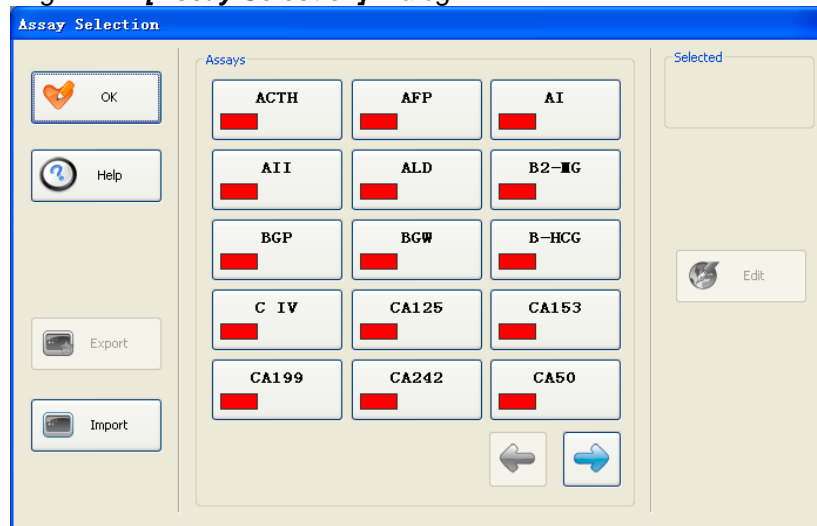





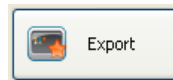
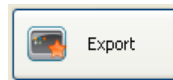
Functions] dialog box. Then press . This opens the **[Assay Selection]** dialog box for selecting the desired test. (See fig.7.2-1)

Fig. 7.2-1: **[Assay Selection]** Dialog

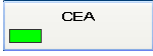
	This button is used for exporting files from the MAGLUMI [®] software.	7.2.1 [Assay Selection] icon, <Export> in detail
	This button is used for inserting assay method files into the MAGLUMI [®] software.	7.2.2 [Assay Selection] icon, <Import> in detail
	Using this type of icon in combination with the <Edit> icon accesses the [User Specific Data] dialog.	7.2.3 [Assay Selection] icon, <TEST> in detail
	This icon can only be used to enter the [User Specific Data] dialog (but only after selecting a test).	7.2.4 [Assay Selection] icon, <Edit> in detail
	By using the arrows, the user can search page by page for the assay to be selected.	

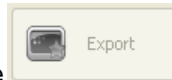
7.2.1 [Assay Selection] icon, <Export> in detail

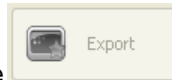


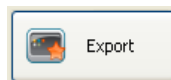
The  icon will save any selected assay file to a floppy disk. Only one assay file may be selected at a time.

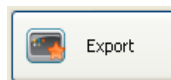
Procedure

a. Select the appropriate assay file by pressing the name of the test and the LED will turn from red to green. 




b. The  icon changes to active only after a test has been selected.



c. Press the  icon. the assay file will be exported to a folder you want.


7.2.2 [Assay Selection] icon, <Import> in detail



The  icon will load any selected assay file to the MAGLUMI[®] software. Only one assay file may be selected at a time.

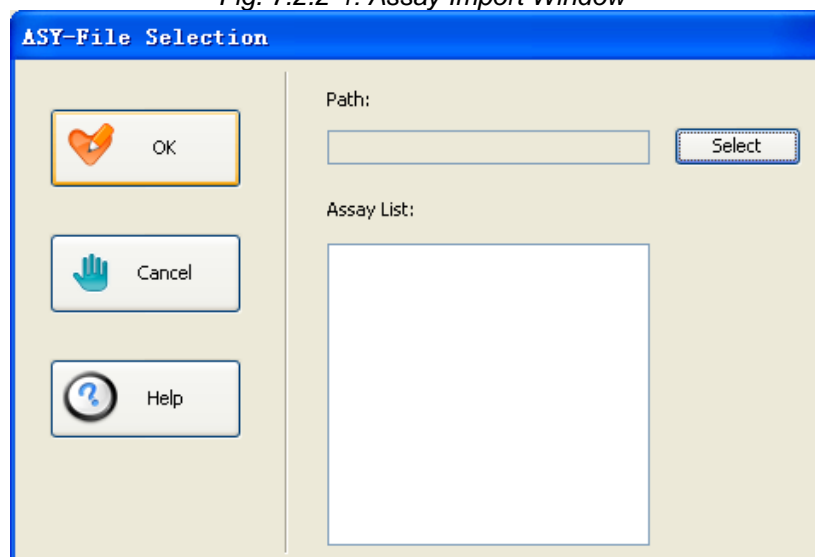
Procedure:



a. Press the  icon.

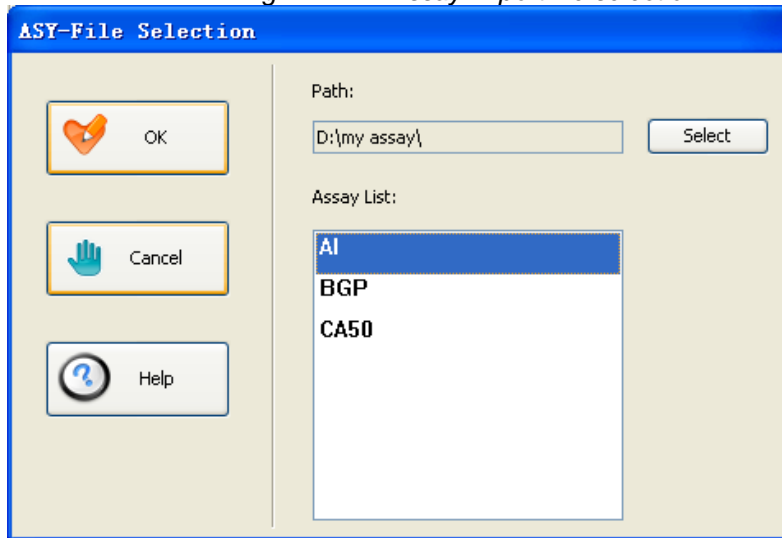
b. The following window will appear. Using the mouse, select the drop down arrow and select the appropriate assay file under the path.

Fig. 7.2.2-1: Assay Import Window



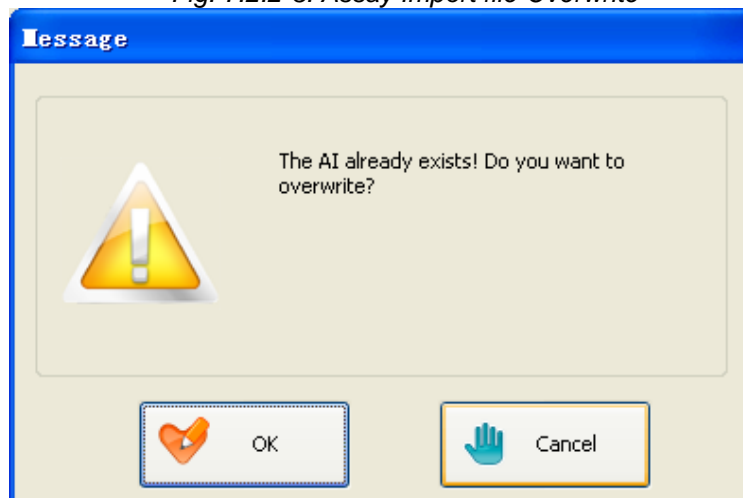
- c. then press “**OK**” to import the assay selected. (See Fig. 7.2.2-2: Assay Import file selection)

Fig. 7.2.2-2: Assay Import file selection



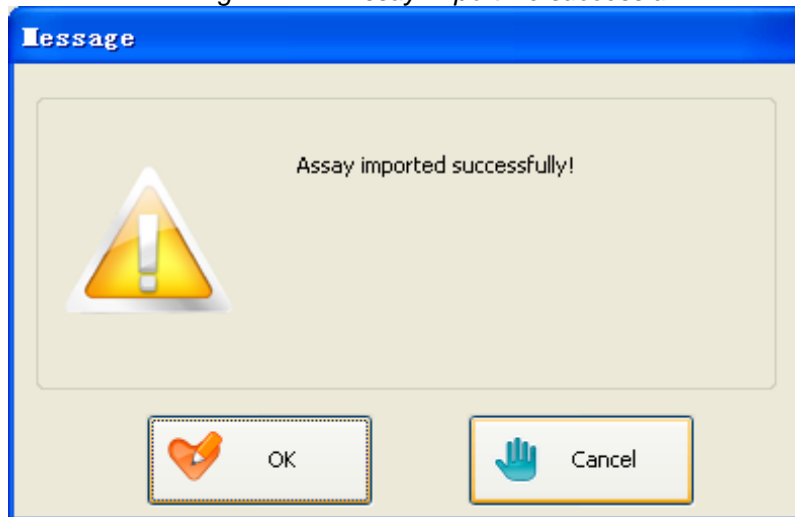
- d. If the assay file previously exists, the software will ask for confirmation of overwriting.
 - a. Press <OK> to overwrite **or**
 - b. Press <Cancel> to cancel.

Fig. 7.2.2-3: Assay Import file Overwrite



- c. If the assay file has been successfully imported, the following pop-up window will appear.

Fig. 7.2.2-4: Assay Import file successful




Each time after running [import] function, the assay **SHOULD** be re-specified relevantly:

- Controls definition
- Dilution definition
- Group definition
- Profile definition


7.2.3 [Assay Selection] icon, <TEST> in detail



The purpose of the  (test selection) icon is to allow the user to choose a specific test to be customized. These test selection icons are found in many sub-dialogs of the MAGLUMI[®] software.


When the user has chosen the required test the icon will change



from red to green . Afterwards the <Edit> icon must be pressed. (See 7.2.4)

7.2.4 [Assay Selection] icon, <Edit> in detail



The purpose of the  icon is to allow the customer to customize the previously chosen test. This icon is also found in many sub-dialogs of the MAGLUMI[®] software.

After the specific test has been selected according to section 7.2.3, the <Edit> icon must be pressed to customize tests. The **[User Specific Assay Data]** dialog will appear as shown in Fig. 7.2.4

This dialog is divided into sections that are explained below by the color-coordinated boxes.

Fig. 7.2.4 [User Specific Assay Data]

The screenshot shows the 'User Specific Assay Data' dialog box. It is divided into several sections:

- Left Panel (Red Box):** Contains 'Save', 'Cancel', 'Help', and 'Master Curve' buttons.
- Top Section (Blue Box):** Basic information including Name (Adrenocorticotrophic Hormone), Abbreviation (ACTH), Unit (pg/mL), Samples Replication (1), Calibration Replication (2), and Calibrate (7 Days).
- Range Settings (Green Box):** Includes Normal Range (6 to 80), Assay Range (0.2 to 2000), Reflex Range 1 (0 to 0), and Reflex Range 2 (0 to 0).
- Right Panel (Purple Box):** Contains 'Auto Dil.', 'Format', 'Qualit. Lbl', 'Reflex 1', and 'Reflex 2' buttons, each with a colored indicator.

Callout boxes provide further details:

- Red Box:** This section is used for saving and canceling changed data. See 7.2.4.1.
- Blue Box:** This section is the basic information section of the assay. See 7.2.4.2.
- Green Box:** This section is used for certain range settings on the assay results. See 7.2.4.3.
- Purple Box:** This section is for setting an **automatic retesting** on the specific assay, set **qualitative result labels, result formats, and viewing master curve information**. See 7.2.4.4.

In general, the assay-specific parameters need be entered only once; they will then be available for all subsequent measurements and processes.

The [User Specific Assay Data] dialog already contains basic assay parameters preset by SNIBE.Co.,Ltd. These form the basis for your special assay data.

It is advisable to back up all changes and definitions regularly by saving the database.



Changes in the definitions in this dialog box can be made only when no Reagent Integral of the corresponding assay is in the reagent station. If a Reagent Integral for the corresponding assay is loaded in the reagent station, then the <OK> button for saving the entries and exiting the dialog is not operational.

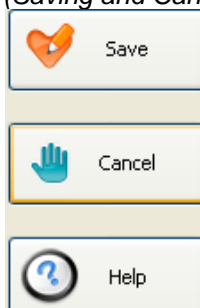
7.2.4.1 [User Specific Assay Data] – Saving and Canceling

The saving and canceling section of the **[User Specific Assay Data]** dialog (see fig. 7.2.4.1) contains the buttons to either:

- 1) **<SAVE>** = Exit the dialog and accept the changes that were made (if any), or
- 2) **<Cancel>** = Exit the dialog without saving any changes that were made.

The **<Help>** icon is not active.

Fig 7.2.4.1 (Saving and Canceling)



7.2.4.2 [User Specific Assay Data] – Information section

The information section of the **[User Specific Assay Data]** dialog (see fig. 7.2.4.2) contains all information concerning the assay identity as set by SNIBE.Co.,Ltd.

Fig. 7.2.4.2: **[User Specific Assay Data]** dialog – information section

Name:	Adrenocorticotropic Hormone	055
Abbreviation:	ACTH	Snibe
Unit:	pg/mL	x 1 = pg/mL
Samples		Calibration
Replication	1	Replication 2
		Calibrate 15 days

[Name:] - The name of the assay (not changeable) and the same line contains the identifier number of the assay.

[Abbreviation:] - The short name form found on the assay icon throughout the software (changeable but not recommended) and the same line contains the manufacturer of this test.

[Unit:] - The given unit of measurement for this assay. The unit of measurement is changeable but it must be ensured that the chosen unit of measurement is converted equally to the original unit of measurement. See the example below:



If the unit of measurements is changed, it is required to also change the range and threshold settings to accommodate the unit of conversion. (See “range settings” 7.2.4.3 & “Qualitative labels” 7.2.4.4.3.1)

[Samples] – The number of replications for each patient result for this assay.

[Calibration] – The number of replications for each calibration result (for this assay) and the number of days a calibration will be valid. This data is changeable only when entering the software using the highest user password.



The calibration data should remain at default as set by the manufacturer. SNIBE.Co.,Ltd . is not liable for results obtained through improper use of calibration settings.

7.2.4.3 [User Specific Assay Data] – range settings

The range settings section of the **[User Specific Assay Data]** dialog (see fig. 7.2.4.3) contains all information concerning the ranges of the assay.

Fig. 7.2.4.3: **[User Specific Assay Data]** dialog – range settings section

The screenshot shows a dialog box with four sections, each with a title and two input fields separated by an ellipsis (...):

- Normal Range**: Input fields contain '6' and '80'.
- Assay Range**: Input fields contain '0.2' and '2000'.
- Reflex Range 1**: Input fields contain '0' and '0'.
- Reflex Range 2**: Input fields contain '0' and '0'.

Normal Range – The expected range for non-pathological samples (this definition may not be clinically applicable to all assays). Measured values which lay outside the range specified here are marked in the **[Daily Lab-Journal]** and **[Valid -Journal]** with “<” or “>” respectively.

Assay Range: - Measuring range limits specified by the reagent manufacturer. Measured values, which exceed this range, are recorded in the **[Daily Lab-Journal]** and **[Valid -Journal]** with “<<” or “>>” respectively.

Reflex Range 1: - A range that may be set by the user to have an additional different test automatically start for a particular sample whose original result falls within the entered reflex range. Measured

values which fall inside this range are marked in the **[Daily Lab-Journal]** and **[Valid -Journal]** with “&”. See the example below:

A reflex range for **<PSA>** is given as shown and the **<reflex Test>** selected is **<fPSA>** (See automatic retesting 7.2.4.4).

When a patient(s) result falls within the range from 3.1 to 5, an automatic start of the test **<fPSA>** will occur for the sample(s). Once a **[Reflex Range]** is activated, it can only be de-activated by removing the **[Reflex Test]** (See automatic retesting 7.2.4.4).

[Reflex Range 2:] - See definition for **[Reflex Range 1]**.



If the unit of measurements is changed, it is required to also change the range and threshold settings to accommodate the unit of conversion.

7.2.4.4 [User Specific Assay Data] – automatic retesting

The automatic retesting section of the **[User Specific Assay Data]** dialog (see fig. 7.2.4.5) contains a selection of tests to be restarted.

AutoReflex and AutoDilution Tests are pooled to form definable groups. When the default is reached these assays are automatically started with STAT priority.

The default setting is stipulated in the “LIA32D.INI” file.

Fig. 7.2.4.4: **[User Specific Assay Data]** dialog – automatic retesting section

7.2.4.4.1 [AutoDilution]

Auto Dilution tests are determinations (assays) that initiate a predefined dilution of the same patient’s sample automatically after a preset value has been exceeded.

For each assay, a concentration as threshold value and the desired dilution level can be preset. If a measured value exceeds this threshold value, the appropriate dilution is automatically started with STAT priority.

When a sample result falls within the range for an Auto Dilution determination, but the selected sample tube is no longer located in the patient area, the test is placed in the Daily Journal with a **[To_Do]** status.

- Auto Dilution determinations are performed independently from manually initiated dilutions.
- The result of a manually pre-selected dilution does not trigger an Auto Dilution function.

The dilution used to perform an Auto Dilution Test is also stipulated.

By pressing the **<AutoDil.>** button, the following dialog box is opened.

Fig. 7.2.4.4.1 **[Auto Dilution Settings]** dialog box

[Threshold concentration] This is the maximum concentration of an undiluted sample result. Any result exceeding this value will be diluted to the given value.

[1st Dilution step]

Sample volume: Amount of the sample volume

Buffer volume: Amount of the buffer volume

All dilutions that exceed a volume of 500 µl, must be performed in two steps (1st and 2nd Dilution steps)

[2nd Dilution step]

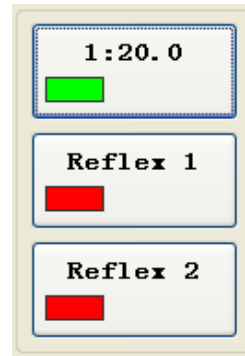
Vol. from 1st step: Amount of the sample volume

Buffer volume: Amount of the buffer volume

[Dilution]

Display of the dilution level (calculated from sample and buffer volumes)

Upon closing the **[Auto Dilution Settings]** dialog box by pressing the **<OK>** button, the previously defined dilution is saved and displayed as pictured below.



If **<Cancel>** is pressed the dialog will close without saving any defined dilutions.

7.2.4.4.2 [AutoReflex]

Auto Reflex tests are determinations which are automatically started by default settings after one assay has been completed. Auto Reflex tests are performed using STAT Priority.

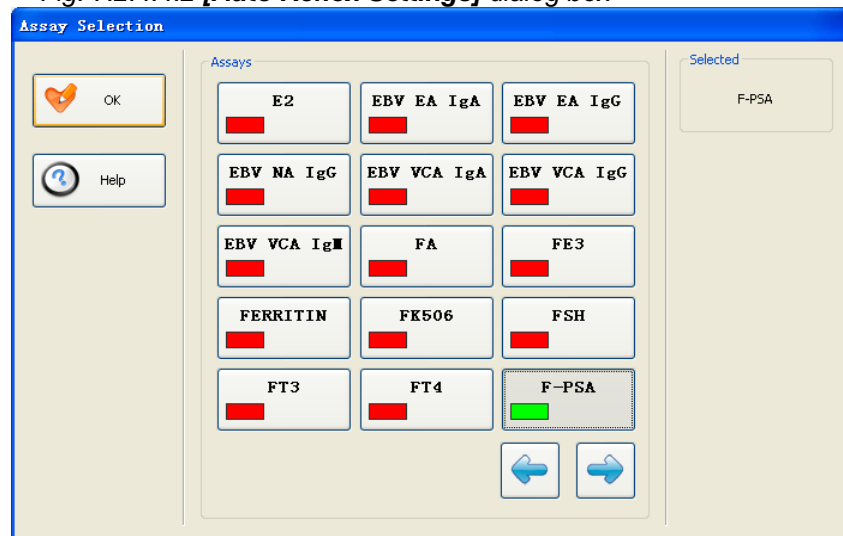
For each assay only 2 ranges (Reflex Ranges [see 7.2.4.4.2]) with corresponding reflex tests can be defined.

Example: A Reflex Range can be set for PSA and assigned to the fPSA assay. If the PSA result falls within the Reflex Range, a fPSA determination is automatically started. When a sample result falls within the range for an Auto Reflex determination, but the selected sample tube is no longer located in the patient area, the test is placed in the Daily Journal with a [**To_Do**] status.

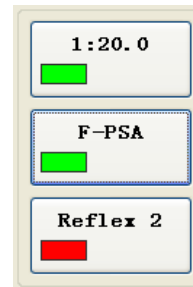
The tests to be selected for Auto Reflex are found in this dialog box. Up to 2 tests can be defined, for each assay, by using the **<Reflex1>** and **<Reflex2>** buttons.

Upon depressing the **<Reflex 1>** button the following dialog box opens.

Fig. 7.2.4.4.2 [Auto Reflex Settings] dialog box



By selecting the appropriate assay button, and afterwards pressing **<OK>**, the AutoReflex Test is confirmed and displayed in the reflex section as shown below (in the example shown F-PSA).



To cancel an already selected entry, press the button of the assay until it turns from green to red.
If **<OK>** has already been selected, press the displayed assay once and the **[Reflex 1]** icon will reappear.

7.2.4.4.3 [User Specific Assay Data] – Qualitative result labels, result format, master curve information

The qualitative result labels, result format & master curve information section of the **[User Specific Assay Data]** dialog (see fig. 7.2.4.4.3) contains all information concerning the result appearance and master curve information of the assay.

Fig. 7.2.4.4.3: **[User Specific Assay Data]** dialog – Qualitative result labels, result format and master curve



7.2.4.4.3.1 <Qualitative Labels>

All result displays (in all journals, detailed dialogs and print-outs) can be assigned an additional qualitative label.

Only the calculated mean value is labelled (marked)
Individual values (*single replicates*) are not labelled (marked).

Up to 3 threshold values and 4 different labels (designations) can be set for each assay.

These label designations can be labelled with max. 5 alphanumeric characters.

When using the maximum amount of characters, the display label in the [Daily Lab – Journal] will be set against the next display field.

By pressing the <Qualit.Ibl> button, the following dialog box (see Fig. 7.2.4.4.3.1) is opened.

Fig. 7.2.4.4.3.1. [Qualitative Settings] dialog box

[Number Of Thresholds] Definition of the number of the threshold values

[Thresholds] Actual threshold value in unit of measurement

[Labels] Input of the alphanumeric label designations



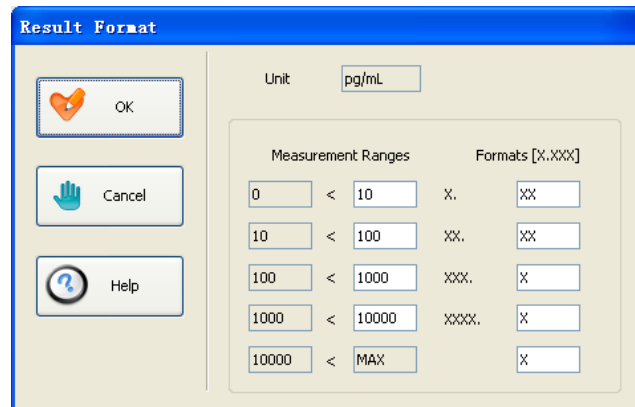
If the unit of measurements is changed, it is required to also change the range and threshold settings to accommodate the unit of conversion. (See “information section” 7.2.4.2 & “Range settings” 7.2.4.3)

7.2.4.4.3.2 <Format>

All result displays (in all journals, detailed dialogs and print-outs) can be assigned an assay specific format.

To change the measuring range limits, press the <Format> button.

Fig. 7.2.4.4.3.2: **[Result Format]** dialog box for defining the measuring range limits and numerical formats.



<Format> Pressing **<Format>** produces the **[Result Format]** dialog box. Entry of the particular upper range limit automatically changes the lower limit of the next higher range. Range-specific numerical formats can be defined for these ranges.

Example: "x.xx" signifies: with a single digit value, 2 decimal places are included and shown in the **[Daily Lab-Journal]**. Confirm the entry and return to the **[User Specific Assay Data]** dialog box by pressing **<OK>**.

7.2.4.4.3.3 **<MasterCurve>**

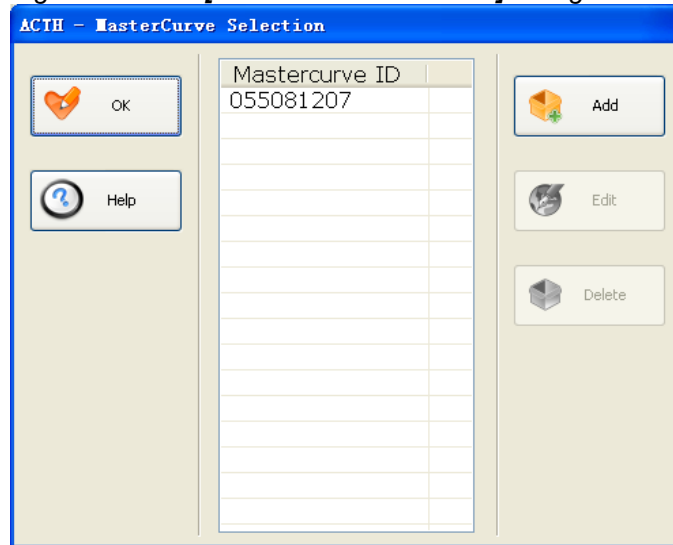
The basis of the working curve calibration is the master curve valid for the assay concerned, whose data are specified by the reagent manufacturer.

The master curve may change from lot to lot for any given assay. When a master curve change is necessary for an assay, the method file for that assay must be overwritten. The new method file will always accompany the assay integral in the form of RFID tag.

The master curve applicable in each case is marked with ID numbers on every Reagent Integral.

When **<MasterCurve>** is pressed, the **[Mastercurve Selection]** dialog box appears.

Fig. 7.2.4.4.3.3: [Mastercurve Selection] dialog box



The master curves are displayed line-by-line with Identification numbers [**Mastercurve ID**].

<Add> the icon used when entering a new master curve.

<Edit> the icon used for editing an existing master curve.

<Delete> the icon used when deleting a master curve.

<OK> the icon used for exiting the dialog and reentering into the "User Specific Assay Data" dialog.

How to:

Add a master curve:

Press <Add> to open the [**Loading Of Master Curve**] dialog box. Information can then be entered in the empty fields as pictured in fig. 7.2.4.4.3-3.

Edit a master curve:

Select a master curve and press <Edit>. The [**Loading Of Master Curve**] dialog box appears.

Delete a master curve:

After selecting a master curve and pressing <Delete>, the master curve is deleted after confirmation with <OK>.

Fig. 7.2.4.4.3.4: [Loading Of Master Curve] dialog box

No.	RLU	Conc.
1	4473	0.000
2	5306	0.050
3	7500	0.129
4	10572	0.334
5	16943	0.865
6	34587	2.236
7	64103	5.782
8	134136	14.953
9	294080	38.670
10	601299	100.000

[Data of master curve]

Entry of individual master curve values. These are entered in lines point by point. A master curve with max. 10 points on the curve can be entered.

[Identifier]

Entry of the ID number of the master curve **[Mastercurve ID]**.

[Lot-No.]

Lot number

[RLU]

Entry of RLU values.

[Concentration]

Entry of associated concentration values.

[No. of points]

Number of points on the master curve.

<Recalc.>

After entry of the data, press **<Recalc.>** to calculate and display the master curve.

<Print>

Print the master curve and the data.

<OK>

Press to return to the **[Mastercurve Selection]** dialog box and after confirming once more with **<OK>**, the **[User Specific Assay Data]** dialog box re-appears.

<Cancel>

Press to return to the **[Mastercurve Selection]** dialog box without any changes being saved.

7.3 <Control> icon in detail

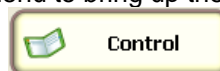
Access levels: Only the highest user password may enter & edit controls. All other user levels may only delete expired controls.

The control icon is used to enter, edit, and delete controls in the software.

If a control is not entered in the databank, the software will not recognize the control as an actual control and will process the control as a patient.

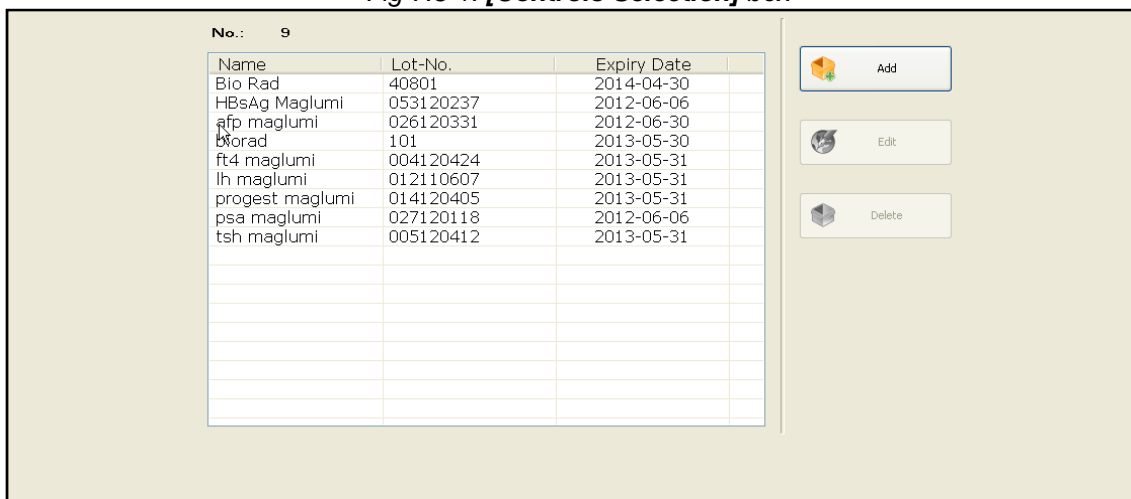
If the QC program is utilized and the control is not registered in the databank, the control result will not be transferred to the QC databank.

Select <Definitions> in the main menu to bring up the [Definition



Functions] dialog box. Then press and open the control selection box. (See fig.7.3-1)

Fig 7.3-1: [Controls Selection] box



	This button is used for adding a new control to the databank of the MAGLUMI® software.	7.3.1 [Contro Selection] icon, <Add> & <Edit> in detail
	This icon can only be used to enter the [Control Data Input] dialog (but only after selecting a control).	7.3.1 [Control election] icon, <Add> & <Edit> in detail
	This icon is used for deleting a selected control from the databank of the MAGLUMI® software.	7.3.2 [Control election] icon, <Delete> in detail

7.3.1 [Control Selection] icon, <Add> & <Edit> in detail



The **Add** icon is to be used when adding a new control to the databank. Only one control may be added at a time.



The **Edit** icon is to be used when editing an existing control in the databank. Only one control may be edited at a time. When **<Add>** or **<Edit>** are pressed, the following dialog appears (see fig. 7.3.1.1-1):

This dialog is divided into sections that are explained below by the color-coordinated boxes.

Fig 7.3.1-1 <Add> ([Control Data Input] dialog)

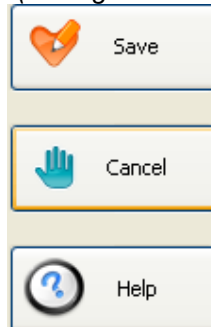
7.3.1.1 [Control Data Input] – Saving and Canceling

The saving and canceling section of the **[Control Data Input]** dialog (see fig. 7.3.1.1-1) contains the buttons to either;

- 1) **<OK>** = Exit the dialog and accept the changes that were made (if any), or
- 2) **<Cancel>** = Exit the dialog without saving any changes that were made.

The **<Help>** icon is not implemented.

Fig 7.3.1.1-1 (Saving and Canceling)



7.3.1.2 [Control Data Input] – control specification

The control specification section of the **[Control Data Input]** dialog (see fig. 7.3.1.1-1) contains basic information concerning the control identity as set by the manufacturer.

Fig. 7.3.1.2-1 **[Control Data Input]** dialog – **[Control Specification]** section

 The screenshot shows a dialog box titled 'Control Specification'. It contains three input fields:

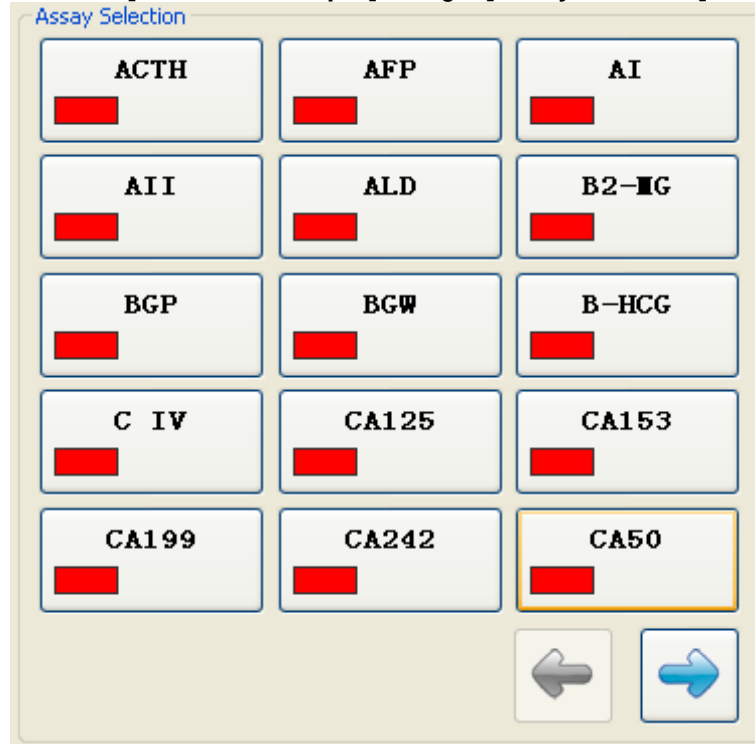
- Name:** A text input field.
- Lot-No.:** A text input field.
- Expiry Date:** A date selection field showing '2011- 4- 2' with a dropdown arrow.

- Name:** - The name of the control (max. 15 characters). This field is changeable in case a mistake has been made.
- Lot-No.:** - The lot number of the control (max. 14 characters). See control IFU for SNIBE.Co.,Ltd manufactured controls.
- Expiry Date:** - The date of expiry for the given control (see specific control IFU). When entering a control for the first time the current date +1 year will be shown and must be changed to the actual expiry date. SNIBE.Co.,Ltd supplied controls should be set to the expiry date stated in the control IFU.

7.3.1.3 [Control Data Input] – Selection of the assay

The assay selection section of the **[Control Data Input]** dialog (see fig. 7.3.1.3-1) contains a list of all assays that can be defined to controls.

Fig. 7.3.1.3-1 [Control Data Input] dialog – [Assay Selection] section



The available assays are displayed in this area in the form of icons. Each control must be assigned to at least one assay.

How To:

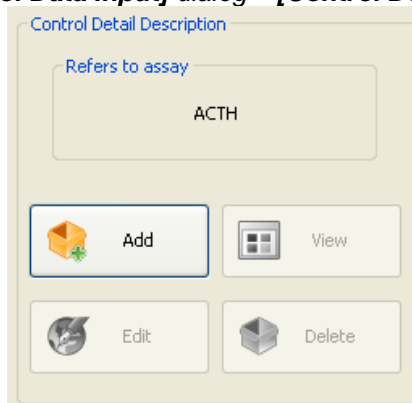
Select an assay for the control displayed by pressing the corresponding button. The color of the button window will then change from red to green, and the assay selected will be displayed in the [Refers to assay] entry field of the [Control Detail Description] section.

Pressing the assay button again cancels the assay assignment and the color of the button window changes back to red.

The arrow buttons are used to page through the assay selection pages.

7.3.1.4 [Control Data Input] – Control detailed descriptions

Fig. 7.3.1.4-1 [Control Data Input] dialog – [Control Detail Description] section



- <Add>** Button for entering detailed control data. The **[Control Detail Description]** dialog box appears when pressing this icon, and the fields are open for entering values.
- How to:**
- See: “**Procedure for adding a Control**”
- <View>** Button to view existing control data without being able to change this data. The **[Control Detail Description]** dialog box appears when pressing this icon, and the value fields are closed and can only be viewed.
- How To:**
- Select an assay assigned to the control to be tested in the **[Assay Selection]** area. The assay buttons are shown in dark gray with a red window. On selecting a button, the window changes to green and the assay appears in the **[Refers to assay]** entry field. Then press **<View>**. The **[Control Detail Description]** dialog box appears with the corresponding control data. The data can only be viewed and not editable.
- <Edit>** Button for editing or viewing existing detailed ranges for the selected control. The **[Control Detail Description]** dialog box appears when pressing this icon, and the value fields are open for editing values.
- How To:**
- Select an assay assigned to the control to be edited in the **[Assay Selection]** area, and then press **<Edit>**. The **[Control Detail Description]** dialog box with the corresponding control data then appears and can be changed as required.
- <Delete>** Button for deleting the ranges settings for this specific control and this specific test in the **[Control Detail Description]** dialog box.
- How To:**
- After selecting a control and the associated assay, the control ranges are deleted by pressing the **<Delete>** button and confirming with **<Yes>**. New control ranges can be entered after pressing **<Add>**.
- <OK>** Pressing **<OK>** confirms the entry and exits this dialog to the **[Controls Selection]** dialog box.
- <Cancel>** Pressing **<Cancel>** exits the dialog without saving the entries and returns to the **[Controls Selection]** dialog box.

7.3.1.4.1 [Control Data Input] – Control detailed descriptions

Fig. 7.3.1.4.1-1 [Control Data Input] dialog – [Control Detail Description] dialog

[Refers to Assay] Non-changeable information referring to the selected assay.

[Control Data] Non-changeable information referring to the selected control.

[Accuracy Control] An accuracy control (A) constitutes a control whose set value and range are preset.

[Precision Control] A precision control (P) constitutes a control whose set value and range are computed through a number of preceding control measurements in the pre-period.

[Replications:] Number of replications the control will run when selecting this assay related control. (The replication value can be set between 1-3)

[Range:] The given expected range of the assay related control is entered here. The first field is for the lower value and the second field is for the higher value.

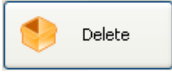
[Target CV [%]:] A target value constitutes a value that is expected as a result for a control. A maximum significant deviation of the control result from the target value is set here as a percentage in CV.

[Ref. Range:] A customer specific range is allowed to be entered in these fields.

7.3.1.5 [Control Data Input] – Procedure for adding a control

- a. Press the **<Add>** icon in the **[Controls Selection]** dialog (fig. 7.3-1) and the dialog **[Control Data Input]** (fig. 7.3.1-1) will appear.
- b. In the **[Control Specification]** area enter the name, Lot-No., Expiry Date, and Barcode-ID (see section 7.3.1.2).
- c. Select the appropriate assay file by pressing the name of the appropriate test in the **[Assay Selection]** area (see section 7.3.1.3).
- d. The test will appear in the **[Control Detail Description]** area (see section 7.3.1.4).
 - d.1. Select **<Edit>** to enter into the **[Control Detail Description]** dialog (see fig 7.3.1.4.1-1 **[Control Data Input]** dialog – **[Control Detail Description]** dialog).
 - d.2. Enter the required data as described in section 7.3.1.4.1 (see relevant control IFU for required ranges).
 - d.3. After all required fields have been completed, press **<OK>** to exit the dialogs.

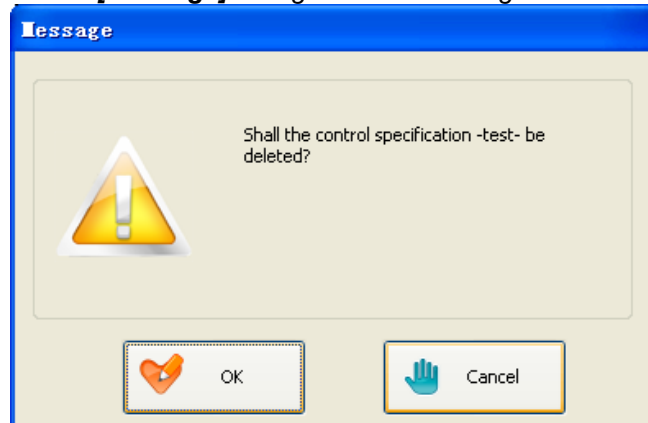
7.3.2 [Control Selection] icon, <Delete> in detail

Pressing the icon  from the [Control Selection] dialog deletes the complete selected control.

How To:

Select the appropriate control in the [Controls Selection] dialog, and then press <Delete>. The message in fig 7.3.2-1 will appear.

Fig 7.3.2-1: [Message] dialog – Delete message



If the control should actually be deleted confirm the deletion with <OK>. If an error has been made and the wrong control has been selected, the operation can be canceled by pressing <Cancel>.

NOTE

The item cannot be recovered once it has been deleted.

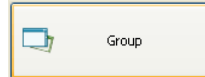
7.4 <Group> icon in detail

Access levels: All user levels may enter & edit and delete tests from groups.

The group icon is used to enter, edit, and delete tests from assigned groups in the software.

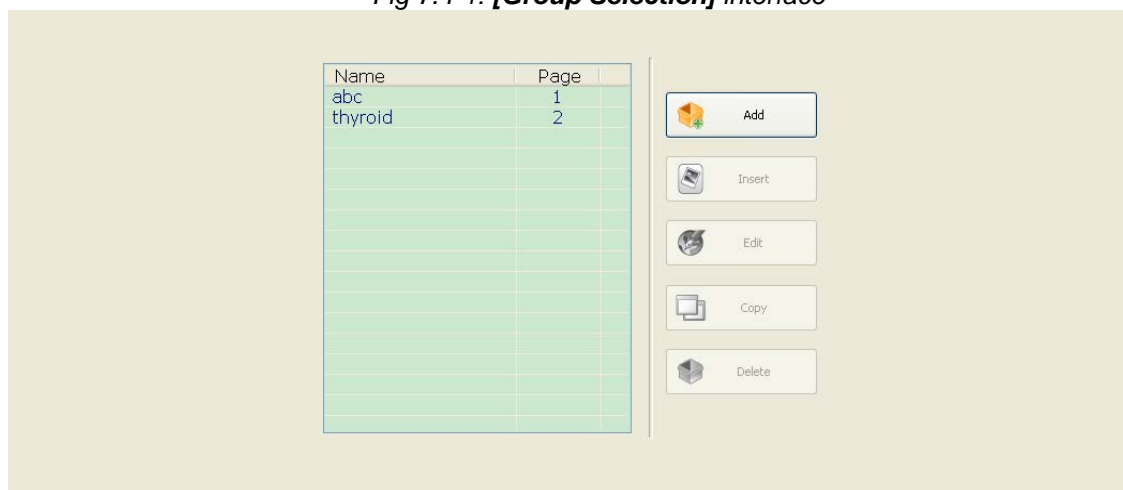
If a test is not assigned to a group, the test will not be visible in the patient dialog, and therefore will not allow the assignment of this test to a patient sample.



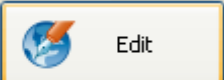
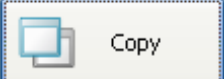

Select **<Definitions>** in the main menu and then press



. This opens the **[Group Selection]** interface for selecting the desired test. (See fig.7.4-1)

Fig 7.4-1: **[Group Selection]** interface

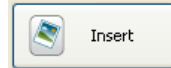


 Add	This button is used for adding a new group to the databank of the MAGLUMI® software.	7.4.1 [Group Selection] icon, <Add>, <Insert>, <Edit> & <Copy> in detail
 Insert	This icon can be used to insert an existing group to a certain page in the [Assay Group Definition] dialog (but only after selecting a group).	7.4.1 [Group Selection] icon, <Add>, <Insert>, <Edit> & <Copy> in detail
 Edit	This icon can be used to edit an existing group in the [Assay Group Definition] dialog (but only after selecting a group).	7.4.1 [Group Selection] icon, <Add>, <Insert>, <Edit> & <Copy> in detail
 Copy	This icon can be used to copy an existing group in the [Assay Group Definition] dialog (but only after selecting a group).	7.4.1 [Group Selection] icon, <Add>, <Insert>, <Edit> & <Copy> in detail
 Delete	This icon is used for deleting a selected group from the databank of the MAGLUMI® software.	7.4.2 [Group Selection] icon, <Delete> in detail

7.4.1 [Group Selection] icon, <Add>, <Insert>, <Edit> & <Copy> in detail



The **Add** icon is to be used when adding a new group to the databank. Only one group may be added at a time and this group will always be added at the end of the page list.



The **Insert** icon is to be used when inserting a new group between two pages (reorganizing pages). Only one group may be inserted at a time.



The **Edit** icon is to be used when editing any existing control in the databank. Only one control may be edited at a time.



The **Copy** icon is to be used when copy any existing group in the databank (with the intention to edit). Only one group may be copied at a time.

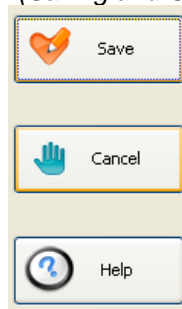
When any of these four icons are pressed, the following dialog appears:

7.4.1.1 [Group Selection] – saving and canceling

The saving and canceling section of the **[Assay Group Definition]** dialog (see fig. 7.4.1-1) contains the buttons to either:

- 1) **<Save>** = Exit the dialog and accept the changes that were made (if any), or
- 2) **<Cancel>** = Exit the dialog without saving any changes that were made. The **<Help>** icon is not active.

Fig 7.4.1.1-1 (Saving and Canceling)



7.4.1.2 [Group Selection] – [Selected Assay]

The **Selected Assay** section of the “**Assay Group Definition**” dialog (see fig. 7.4.1-1) contains the name of the currently selected assay.

Fig. 7.4.1.2-1 “Assay Group Definition” dialog – Selected Assay section

Assay Group Definition

Selected Assay

Assay Selection

ACTH	AFP	ALD
B2-MG	BGP	BGW
C IV	CA125	CA153
CA199	CA242	CA50
CA724	CAFP	CEA

Assay Group

Name:

Page:

1	2	3
4	5	6
7	8	9
10	11	12
13	14	15

Selected Assay: CMV IgG

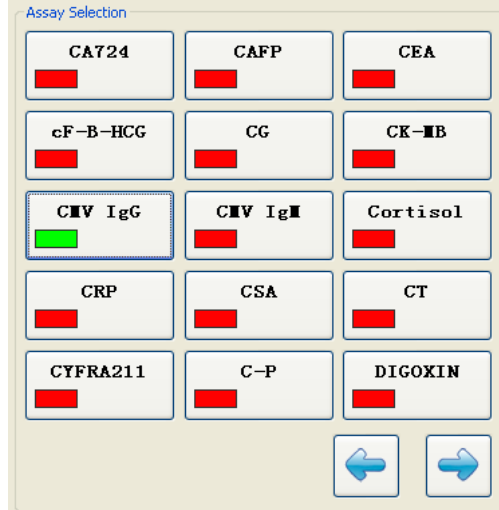
Assay Selection

CA724	CAFP	CEA
cF-B-HCG	CG	CK-MB
CMV IgG	CMV IgM	Cortisol
CRP	CSA	CT
CYFRA211	C-P	DIGOXIN

7.4.1.3 [Group Selection] – Assay Selection

The [Assay Selection] section of the [Assay Group Definition] dialog (see fig. 7.4.1.3-1) contains a list of all assays that can be assigned to a group.

Fig. 7.4.1.3-1 [Assay Group Definition] dialog – [Assay Selection] section



The available assays are displayed in this area in the form of icons.

NOTE *Each assay must be assigned to at least one group.*

How To:

Select an assay for the group displayed by pressing the corresponding button. The color of the button window will then change from red to green, and the **[Assay Group]** section will also change from inactive to active.

Pressing the assay button again cancels the assay assignment. The color of the button window changes back to red, and the **[Assay Group]** section will also change from active to inactive.

The arrow buttons are used to page through the assay selection pages.

7.4.1.4 [Group Selection] – [Assay Group]

The **[Assay Group]** section is where the group name can be:

- Entered when “Adding a Group”
- Edited when “Editing a Group”
- Renamed when “Copying a Group”

The number of the assigned page can be located in the field **[Page:]**. The contents of the group are displayed as numbered icons (red) where no assay is present and assay names (green) where an assay has been assigned to that position. (see fig. 7.4.1.4-1)

Fig. 7.4.1.4-1 [Assay Group Definition] dialog – [Assay Group] section

7.4.1.5 [Group Selection] – Procedure for assigning an assay to an existing group

- In the **[Group Selection]** dialog, select a group where the assay should be added.
- Press the **<Edit>** icon and the **[Assay Group Definition]** dialog (fig. 7.4.1-1) will appear.
- Select the appropriate assay from the **[Assay Selection]** section. (see section 7.4.1.3).
- Select any non-occupied position (numbered icon) in the **[Assay Group]** section and the icon will change to the name of the selected assay (see section 7.4.1.4).
- Repeat steps a-d for any additional assays.

NOTE

If an assay is placed into a group by mistake, the assay can be removed by pressing the appropriate icon in the [Assay Group] section.

7.4.1.6 [Group Selection] – Procedure for assigning a new group to the database

- In the **[Group Selection]** dialog, select the **<Add>** icon and the **[Assay Group Definition]** dialog (fig. 7.4.1-1) will appear.
- Enter a name for the group in the **[Name:]** field of the **[Assay Group]** section (see section 7.4.1.4).
- Select the appropriate assay from the **[Assay Selection]** section (see section 7.4.1.3).
- Select any non-occupied position (numbered icon) in the

Assay Group section and the icon will change to the name of the selected assay (see section 7.4.1.4).

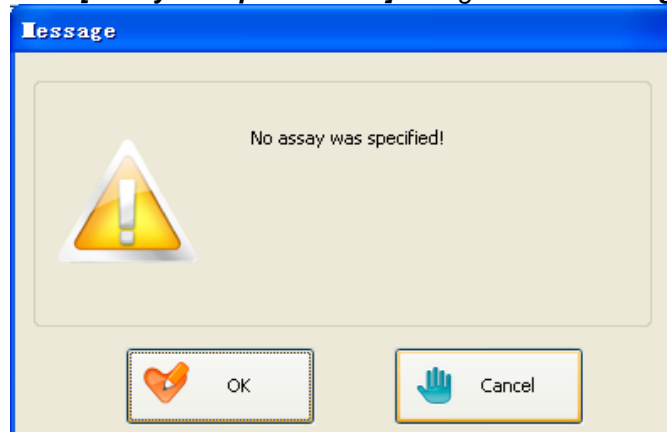
- e. Repeat steps a-d for any additional assays.

NOTE

If an assay is placed into a group by mistake, the assay can be removed by pressing the appropriate icon in the [Assay Group] section.

A group that contains no assays cannot be added to the database. An error message will appear informing the user that no assays have been assigned to this group (fig. 7.4.1.6-1). Pressing **<OK>** cancels the error message, but it will not be possible to exit the **[Assay Group Definition]** dialog with **<OK>**.

Fig. 7.4.1.6-1 **[Assay Group Definition]** dialog – **Error message**



7.4.1.7 [Group Selection] – Procedure for inserting a new group to the database

- a. In the **[Group Selection]** dialog, select the page that would be after the new group.
- b. Select the **<Insert>** icon and the **[Assay Group Definition]** dialog (fig. 7.4.1-1) will appear.
- c. Enter a name for the group in the **[Name:]** field of the **[Assay Group]** section (see section 7.4.1.4).
- d. Select the appropriate assay from the **[Assay Selection]** section (see section 7.4.1.3).
- e. Select any non-occupied position (numbered icon) in the **[Assay Group]** section and the icon will change to the name of the selected assay (see section 7.4.1.4).
- f. Repeat steps a-d for any additional assays.

NOTE

If an assay is placed into a group by mistake, the assay can be removed by pressing the appropriate icon in the [Assay Group] section.

A group that contains no assays cannot be added to the database. An error message will appear informing the user that no assays have been assigned to this group (fig. 7.4.2.6-1). Pressing **<OK>** cancels the error message, but it will not be possible to exit the **[Assay Group Definition]** dialog with **<OK>**.

7.4.1.8 [Group Selection] – Procedure for copying an existing group to the database

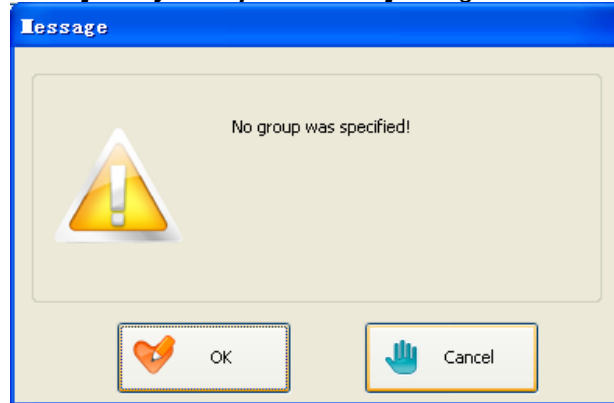
- a. In the **[Group Selection]** dialog, select the group that should be copied.
- b. Select the **<Copy>** icon and the **[Assay Group Definition]** dialog (fig. 7.4.1-1) will appear.
- c. Enter a name for the group in the **[Name:]** field of the **[Assay Group]** section (see section 7.4.1.4).
- d. Add or remove required assays to the **[Assay Group]** section (see section 7.4.1.4).
- e. Repeat steps a-d for any additional assays.

NOTE

If an assay is placed into a group by mistake, the assay can be removed by pressing the appropriate icon in the [Assay Group] section.

A copied group that contains no name cannot be added to the database. An error message will appear informing the user that no name has been assigned to this group (fig. 7.4.1.8-1). Pressing **<OK>** cancels the error message, but it will not be possible to exit the **[Assay Group Definition]** dialog with **<OK>** until a name is given.

Fig. 7.4.1.8-1 [Assay Group Definition] dialog – Error message



7.4.2 [Group Selection] icon, <Delete> in detail

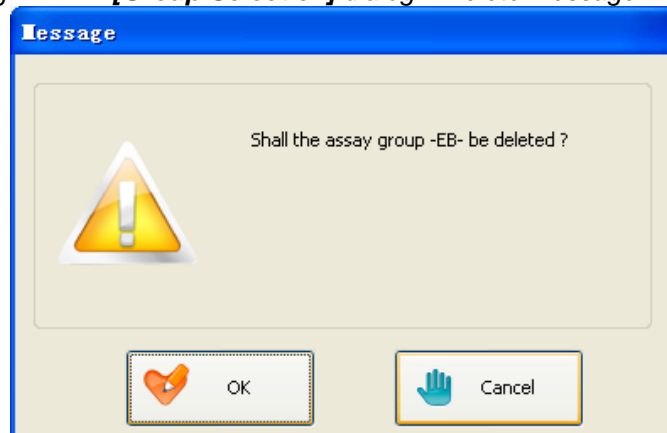


Pressing the icon from the [Group Selection] dialog deletes the complete selected Group including all assay assignments to that group.

How To:

Select the appropriate group in the [Group Selection] dialog, and then press <Delete>. The message in fig 7.4.2-1 will appear.

Fig 7.4.2-1: [Group Selection] dialog – Delete message



If the group should actually be deleted confirm the deletion with <OK>.

If an error has been made and the wrong group has been selected, the operation can be canceled by pressing <Cancel>.

NOTE

An item cannot be recovered once it has been deleted.

7.5 <Sender> icon in detail

Access levels:

All user levels may utilize all functions of the senders.

The definition of the sender icon is to create reference list for external/internal clinics /laboratories. This feature is useful for larger institutions that receive patient samples for testing from smaller institutions or departments on a regular basis.

Any individual patient sample can be assigned to a sender (provided senders are previously listed), which in turn will appear in the "Detailed Sample Result" dialog located in the "Daily Journal" (see chapter 10).

The software is delivered with no senders inserted. They must be set by the user.

The sender icon is used to enter, edit, copy, and delete senders from the software database.

The "Sender" function is strictly an option and is not required for the normal functionality of the MAGLUMI[®] system.

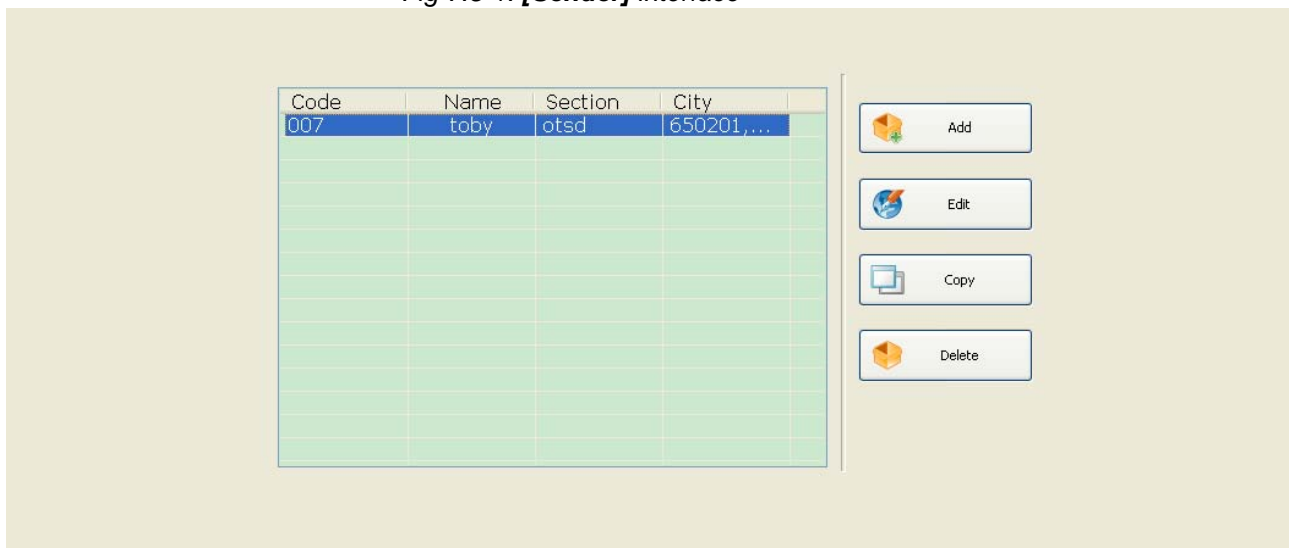
Select **<Definitions>** in the main menu and then press



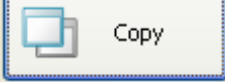
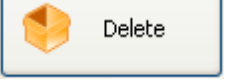


opens **[Sender]** interface for adding, editing, or


deleting senders. (See fig. 7.5-1)


Fig 7.5-1: **[Sender]** interface

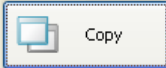


	<p>This button is used for adding a new sender to the databank of the MAGLUMI® software.</p>	<p>7.5.1 [Sender Selection] icon, <Add>, <Edit> & <Copy> in detail</p>
	<p>This icon can be used to edit an existing sender in the sender list (but only after selecting a sender).</p>	<p>7.5.1 [Sender Selection] icon, <Add>, <Edit> & <Copy> in detail</p>
	<p>This icon can be used to copy an existing sender in the sender list (but only after selecting a sender).</p>	<p>7.5.1 [Sender Selection] icon, <Add>, <Edit> & <Copy> in detail</p>
	<p>This icon is used for deleting a selected sender from the databank of the MAGLUMI® software.</p>	<p>7.5.2 [Sender Selection] icon, <Delete> in detail</p>

7.5.1 [Sender Selection] icon, <Add>, <Edit>, & <Copy> in detail

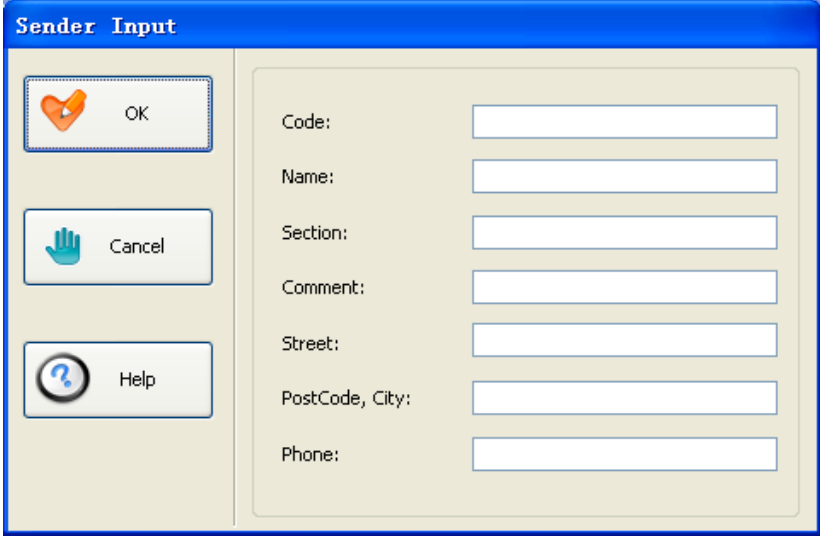
The  icon is to be used when adding a new sender to the databank. Only one sender may be added at a time.

The  icon is to be used when editing any existing sender in the databank. Only one sender may be edited at a time.

The  icon is to be used when copy any existing sender in the databank (with the intention to edit). Only one sender may be copied at a time.

When any of these three icons are pressed, the following dialog appears:

Fig 7.5.1-1: [Sender Input] Dialog



[Code] a client identification code may be entered in this field.

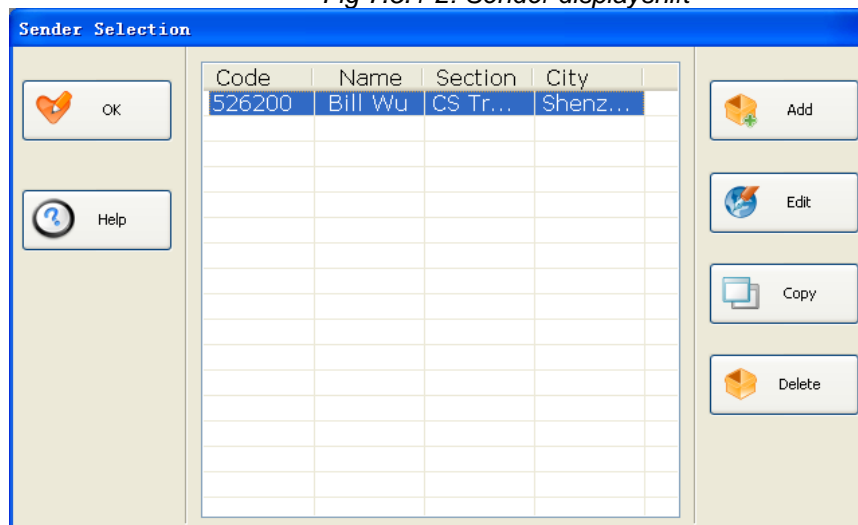
[Name]	the name of the laboratory, clinic, or doctor may be entered in this field.
[Section]	When a certain section or department is available; the department name may be entered here.
[Comment]	any special comments pertaining to this client may be entered here.
[Street]	the street name and number should be entered in this field.
[Postcode, city]	the postal code and the city name are given in this field.
[Phone]	a contact number to the client may be entered in this field.

For the application of the sender see chapter 11

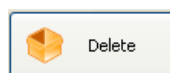
NOTE

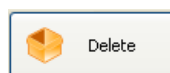
If there are too many characters in any field, the display position may shift to the right (see fig 7.5.1-2).

Fig 7.5.1-2: Sender displayshift



7.5.2 [Sender Selection] icon, <Delete> in detail

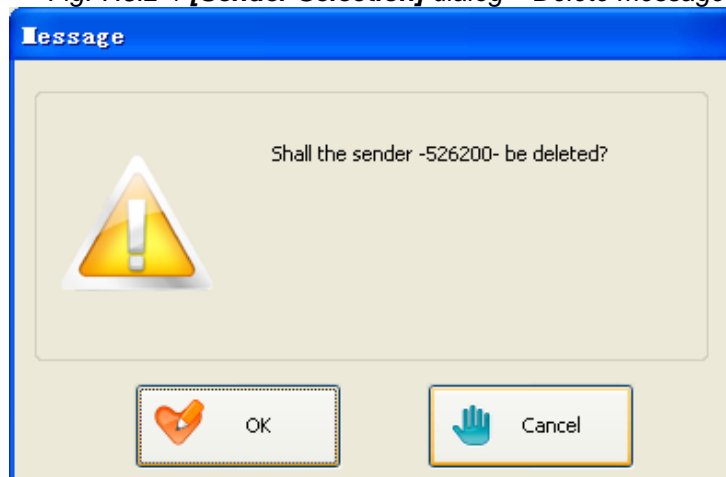


Pressing the icon  from the **[Sender Selection]** dialog deletes the selected sender.

How To:

Select the appropriate client in the **[Sender Selection]** dialog. The selected will be highlighted in blue. Then press **<Delete>**. The message in fig 7.5.2-1 will appear.

Fig. 7.5.2-1 [Sender Selection] dialog – Delete message



If the sender group should actually be deleted, confirm the deletion with **<OK>**.

If an error has been made and the wrong client has been selected, the operation can be canceled by pressing **<Cancel>**.

NOTE

An item cannot be recovered once it has been deleted.

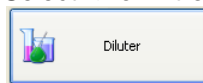
7.6 <Dilut.> Icon in detail

Access levels: Access for this icon is restricted to the highest user level.

The definition of the dilution icon is to assign customer specified dilutions to individual assays/tests. This process provides the user with a selection in the sample loading dialog box for programming the samples. A maximum of 9 dilution steps can be assigned to each assay and an overall maximum of 1:2500 may be diluted on this system. An individual dilution can be assigned to a test, which in turn will appear in the **[Dilution]** section located in the **[Patient Area]** dialog (see chapter 11).

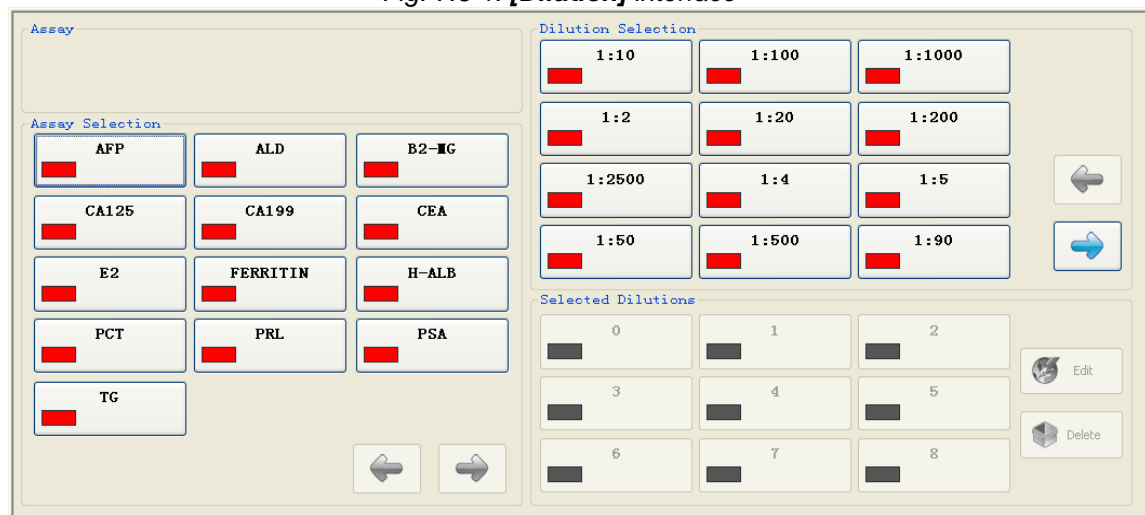
The dilution icon is used to enter, edit, and delete dilutions from the software database.

Select **<Definitions>** in the main menu and then press



to open the **[Dilution]** interface for adding, editing, or deleting dilutions. (See fig. 7.6-1)

Fig. 7.6-1: **[Dilution]** interface



This interface consists of five sections that are explained on the next page by the color-coordinated boxes.

The **Assay** section is for viewing the selected assay. See 7.6.1.

The **Assay Selection** section is used for selecting the appropriate assay to add/remove/edit a dilution. See 7.6.2.

The **Dilution Selection** section is used for selecting a predefined dilution as defined by the reagent manufacturer. See 7.6.3.

The **Selected Dilutions for XXX** section is used for entering/editing, and deleting a dilution for the given assay (whereas "XXX" is the name of the selected assay). See 7.5.2.3.

7.6.1 [Dilution] – Saving and Canceling

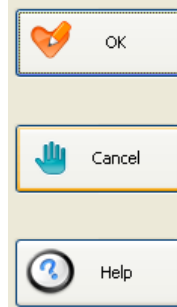
The saving and canceling section of the **[Dilution]** dialog (see fig. 7.6.1-1) contains the button **< OK>**, **< Cancel>** and **<Help>**

1) **<OK>** = Exit the dialog and accept the changes that were made (if any) If any changes are not to be accepted they should be deleted before exiting this dialog.

2) **<Cancel>** = Exit the dialog without saving any changes that were made.

3) The **<Help>** icon is not active.

Fig 7.6.1-1 (Saving and Help)



NOTE

Also when the <Esc> key on the keyboard is pressed, the changes will be confirmed.

7.6.2 [Dilution] – Assay

The **[Assay]** section of the **[Dilution]** interface (see fig. 7.6.2-1) contains a display of the currently selected assay. When an assay is selected in the **[Assay Selection]** section, the assay will also be displayed here.

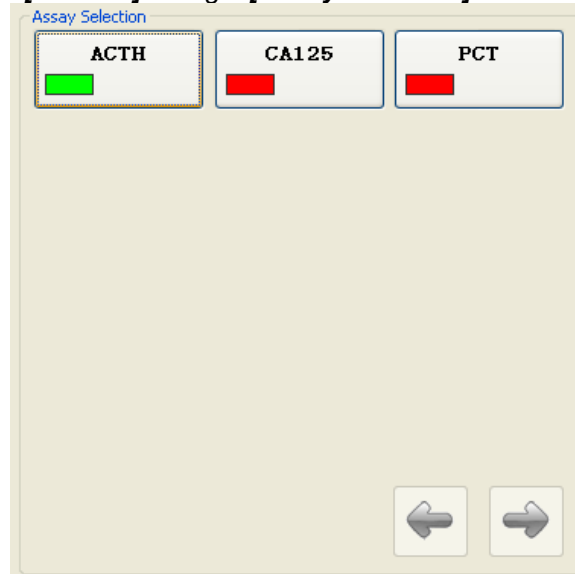
Fig 7.6.2-1 Assay section



7.6.3 [Dilution] – Assay Selection

The **[Assay Selection]** section of the **[Dilution]** interface (see fig. 7.6.3-1) contains a list that a dilution may be assigned to. Some assays may not be selectable due to manufacturer settings.

Fig. 7.6.3-1 [Dilution] dialog – [Assay Selection] section



The available assays are displayed in this area in the form of icons.

How To:

Select an assay that a dilution is needed for by pressing the corresponding assay button. The color of the button window will then change from red to green, and the **[Assay]** section will then contain the name of the selected assay.

Pressing the assay button again cancels the assay assignment. The color of the button window changes back to red, and the name of the selected assay will no longer appear in the **[Assay]** section. The arrow buttons are used to page through the assay selection pages.

7.6.4 [Dilution] – Dilution Selection

The **[Dilution Selection]** section of the **[Dilution]** interface (see fig. 7.6.4-1) contains the possible assignment of dilutions as set by the manufacturer for the selected assay.

There is no limit to the amount of dilutions that may be placed by the manufacturer in this field.

Some assays do not contain the option to dilute. In these certain cases, all dilution icons are inactivated in the **[Dilution Selection]** section.

Fig. 7.6.4-1 [Dilution] interface – [Dilution Selection] section



7.6.5 [Dilution] –Selected Dilutions

The **[Dilution Selection]** section of the **[Dilution]** dialog (see fig. 7.6.5-1) contains the name of the selected assay in the section title and a list of all dilutions that have been assigned to this certain assay.

Only 9 dilution selections may be assigned to an assay.

The dilutions may appear as opted by the user.

This section also contains the icons **<Edit>** & **<Delete>**.

Fig 7.6.5-1 [Selected Dilutions]



7.6.5.1 [Selected Dilutions] - <Edit> in detail

When a certain dilution is needed but not present in the **[Dilution Selection]** section, the user can add it.

By pressing a numbered icon in the **[Selected Dilutions]** section and afterwards pressing “**Edit**” (shown in fig 7.6.5-1) the **[Dilution Specification]** window will appear (see fig 7.6.5.1-1).

Fig 7.6.5.1-1 [Dilution Specification]

The dilution can be defined in two steps, **[1st Dilution Step]** and **[2nd Dilution Step]**, in which one step allows maximum dilution by 50 times (max. overall dilution 1:2500).

[Name]	Name of the dilution step (max. 6 characters).
[Sample volume]	Sample volume in µl.
[Buffer volume]	Buffer volume in µl.
[Vol. from 1st step]	Volume in µl of the dilution from step 1.
[Buffer volume]	Buffer volume in µl.
[Dilution Factor]	Automatic display of the total dilution factor calculated.

Note the sample volume of the assay to be pipetted! (Take account of the residual volume!)

The maximum capacity of the dilutor syringes of 380 µl!
The maximum capacity of the reaction module cavities is 600 µl!

Once the wished values have been entered, press **<OK>** to save the dilution specification for this assay. The program returns to the **[Dilution Definition]** dialog box.

Press **<OK>** to save the assignment of the dilutions to this assay. Or press **<Cancel>** to cancel the setting without saving.

7.6.5.2 [Selected Dilution] - <Delete> in detail

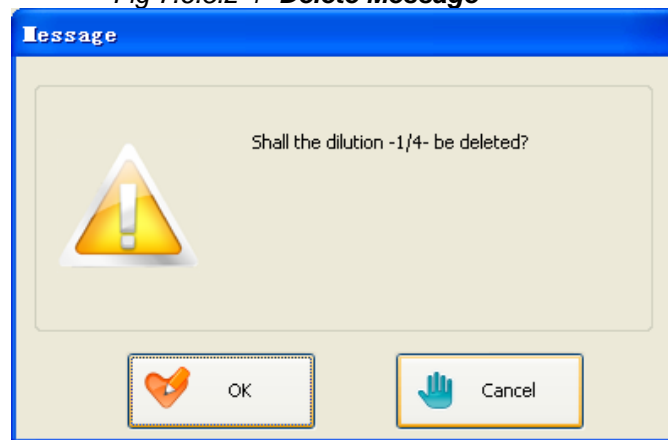


Pressing the icon in the **[Selected Dilutions]** section deletes the selected dilution from the active list for a particular assay.

How To:

Select the appropriate dilution (see fig. 7.6.5-1) in the [**Selected Dilutions**] section. The selected icon will be highlighted in green. Then press **<Delete>**. The message in fig 7.6.5.2-1 will appear.

Fig 7.6.5.2-1 "Delete Message"



If the dilution should actually be deleted, confirm the deletion with **<OK>**.

If an error has been made and the wrong dilution has been selected, the operation can be canceled by pressing **<Cancel>**.

NOTE

The item cannot be recovered once it has been deleted!

7.6.6 <Dilute> How to set a dilution

Dilution steps assigned to an assay in the sequence defined here will appear in the **[Dilutions]** section located in the **[Patient Area]** dialog (see chapter 11).

1. Select an assay in the **[Assay Selection]** area by pressing the appropriate icon. The assay appears with a green window. All icons in the sections **[Dilution Selection]** & **[Selected Dilutions]** are thereby activated (provided dilutions can be assigned to this assay).
2. The dilutions already predefined by the reagent manufacturer appear as dark gray buttons in the **[Selected Dilutions]** section. Proceed as follows for assigning further dilutions to the assay.
3. Press the button with the dilution step you require in the **[Dilution Selection]** section. Buttons not selected appear with a red window and selected buttons appear with a green window.
4. Now position the dilution selected in the **[Selected Dilutions]** section by pressing one of the numbered icons. The dilution name will then be transferred to this icon. This dilution step will appear in the sample-loading dialog at the position defined here once dilutions have been selected for this specific assay.
5. Repeat steps 1-4 for each new dilution.

Each dilution step selected in the **[Dilution Selection]** area can be viewed by pressing **<Edit>** in the **[Selected Dilutions]** area and the dilution parameters changed in the **[Dilution Specification]** dialog box.

Chapter 8

Menu [Process] in detail

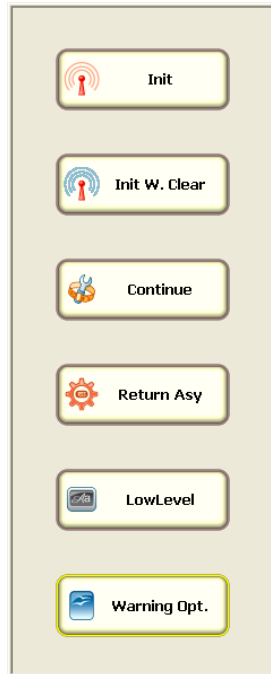
8.1 Process in overview	2
8.2 <Init> icon	2
8.2.1 <Init> icon <OK> in detail	3
8.2.2 <Init > icon <Cancel> in detail.....	4
8.3 <Continue> icon	4
8.4 <Return Asy> icon	4
8.5 <Low Level> icon	5
8.6 < Warning Opt.> icon.....	5

8.1 Process in overview



When the **Process** button is pressed from the main menu, the [Process Functions] sub-window appears on the left of the monitor (see Fig. 8.1-1 Process Functions).

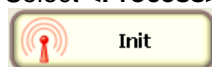
Fig. 8.1-1: Process Functions



	Button for the initialization of the instrument	8.2 <Init> icon in detail
	Button for the initialization of the instrument with cuvette clear	8.2 <Init W. Clear> icon in detail
	Press it to continue the processing for the instrument/assay blocked previously	8.3 <Continue> icon in detail
	Press it to return the determinations of the undone test	8.4 <Return Asy> icon in detail
	Commands to control the assemblies. Intended for the service technician.	8.5 <Low Level> icon in detail
	Warning options of the analyzer	8.6 <Warning Opt.> icon in detail

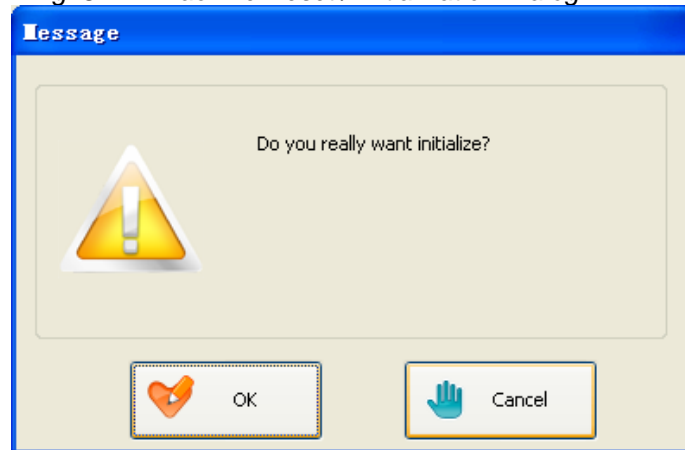
8.2 <Init> icon

Select **<Process>** in the main menu and then press the

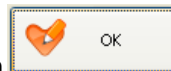


Init icon to open the **[Initialization Dialog]** dialog box with a warning message before executing the initialization. (See fig 8.2-1)

Fig. 8.2-1: Machine Reset / Initialization Dialog



8.2.1 <Init> icon <OK> in detail



Pressing the icon from the <Init> dialog includes the testing of all functions of the analyzer, all assemblies and resetting to the start position. After an <Init> has been performed, the analyzer cycle (shown at the bottom of the monitor screen) is automatically set to "0:1" (Inactive).

NOTE

Please proceed initialization procedure once the analyzer is re-started.

The analyzer is required initialization if there are critical errors occur or the connection of the software and instrument fails.

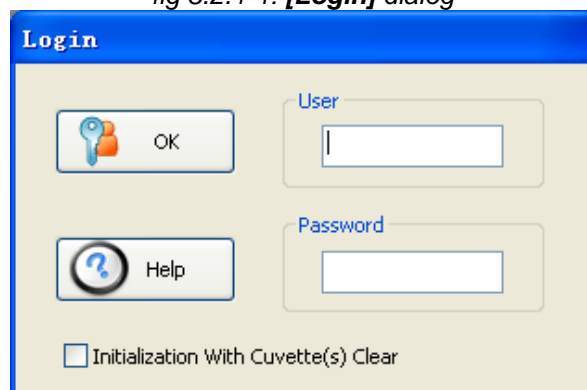
<Initialization With Cuvette(s) Clear> function:

When the analyzer is stopped in mid-run and shut down before the last exit of the software is achieved, there is the possibility that some stray reaction modules are present anywhere in the normal paths of operation on the analyzer. In the case, the <Initialization With Cuvette(s) Clear> function could be proceed.

Procedure:

1. Starting the PC system
2. Double click on the icon < User.exe > to open the MAGLUMI system software. The [Login] dialog displays. (see fig 8.1-2)

fig 8.2.1-1: [Login] dialog



- Input the assigned User name and Password. Check (✓) is selected for <Initialization With Cuvette(s) Clear> and press <OK> to execute initialization of the instrument.

8.2.2 <Init > icon <Cancel> in detail



The icon exits the dialog and returns to the **[Process Functions]** dialog.

8.3 <Continue> icon

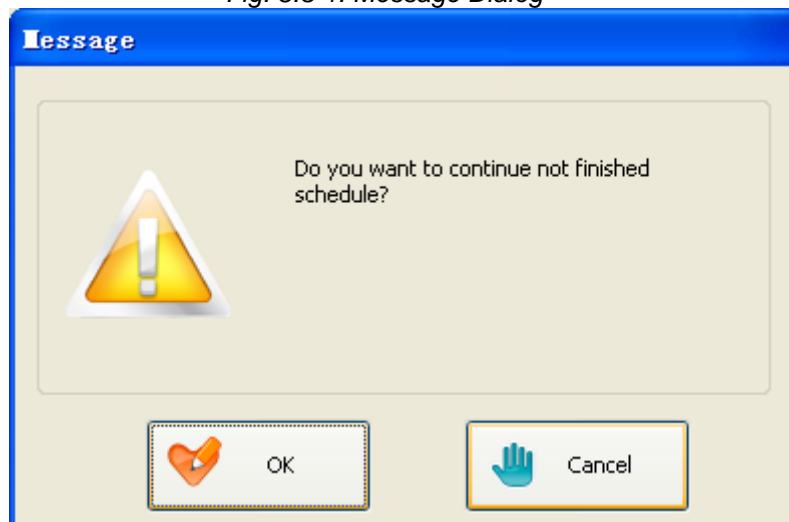
Select **<Process>** in the main menu and then press the



icon to open the **[Continue]** dialog box in order to continue analyzer operations for the instrument/assay interruption or an error message appeared previously (see Fig. 8.3-1)

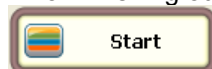
[Continue] icon for continuing analyzer operations after an error message has appeared.

Fig. 8.3-1: Message Dialog

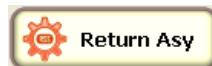


8.4 <Return Asy> icon

When finishing editing the samples and items and press

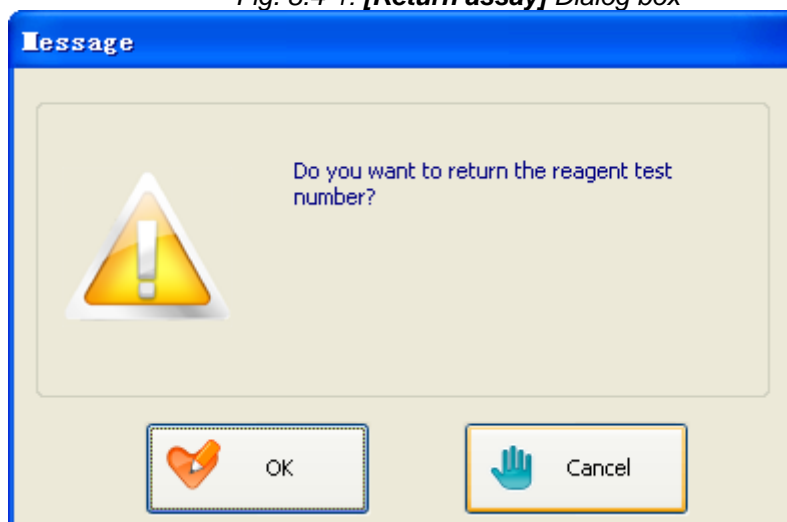


in the main menu, the analyzer will automatically deduct the corresponding number of tests of the reagent kit. If the analyzer shuts down for various reasons without finishing the test, the user can press **<Return Asy>** icon to return the undone tests. Select **<Process>** in the main menu and then press the



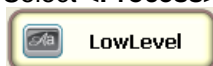
icon to open the **[Return assay]** dialog box with a warning message. (See fig 8.4-1)

Fig. 8.4-1: [Return assay] Dialog box



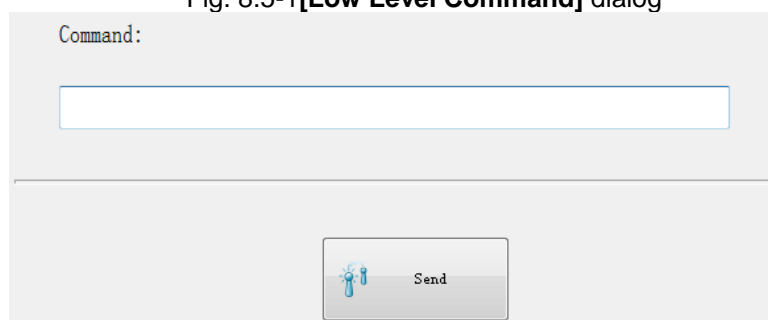
8.5 <Low Level> icon

Select <Process> in the main menu and then press the



icon to open the [Low Level Command] interface, mainly intended for technicians. For reactivating the barcode reader, use the command: **05 01 7F** (see Fig. 8.5-1)

Fig. 8.5-1 [Low Level Command] dialog



	Sends the Low Level command, allows to send several commands without closing the dialog	8.5.1 [Low Level Command] icon, <Send> in detail
--	---	--

[Low Level Command] icon <Send> in detail



Pressing the icon from the [Low Level Command] interface. Clicking on the button sends the Low Level Command specified in Edit Box <Command> to the analyzer. After the command is sent, the Edit Box <Command> will be selected allowing the user to enter the next command directly.

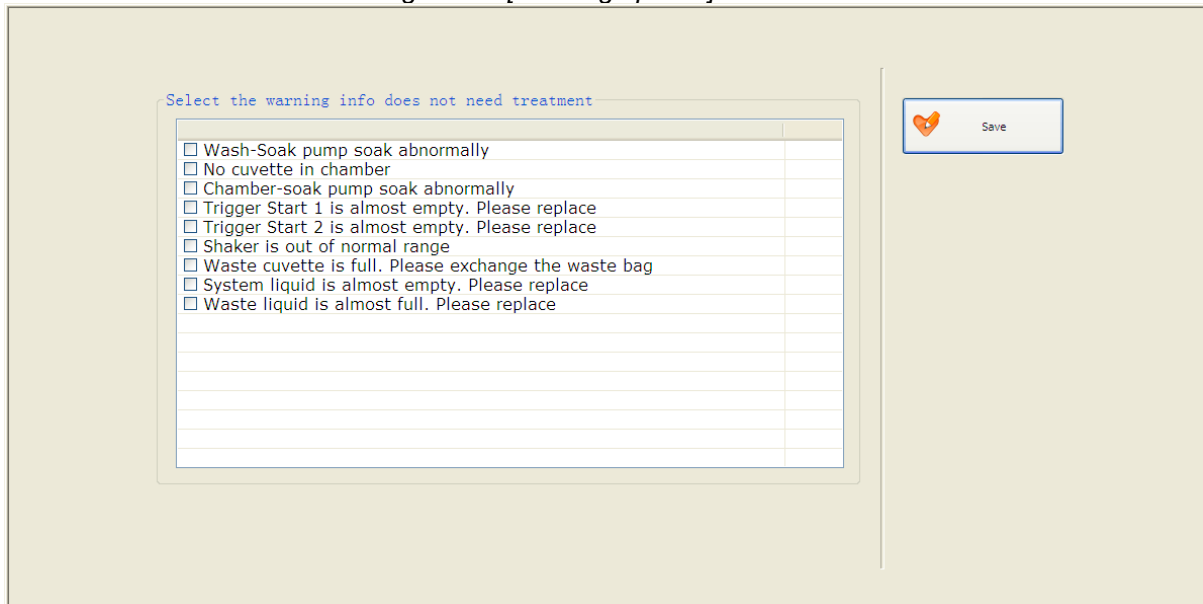
8.6 < Warning Opt.> icon

Select <Process> in the main menu and then press the

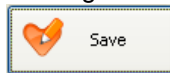


icon to open the **[Warning options]** interface.
(See fig 8.6-1)

Fig. 8.6-1: [Warning options] interface

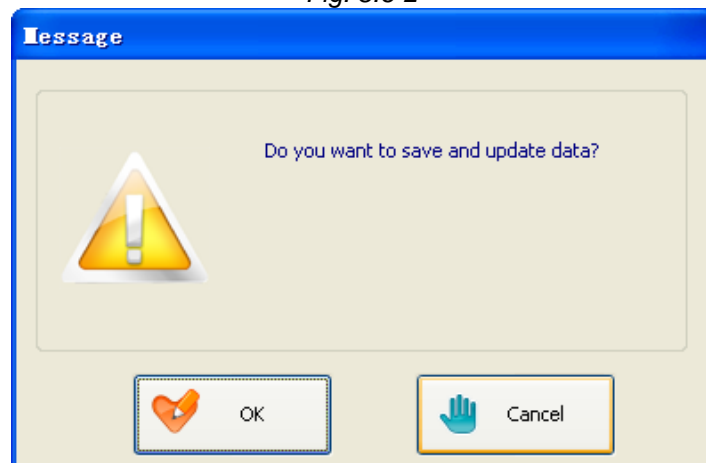


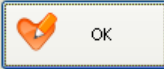

In some cases, i.e. there is something wrong with some part of the analyzer or the sensor, the analyzer will warn. If the user is sure that the analyzer is in proper condition and do not need any of the warning function, check (✓) is selected, then press



and a dialog box will appear to ask the user for conformation.(See fig. 8.6-2)

Fig. 8.6-2



Click  to save and return to the warning options interface and  to return to the warning options interface without saving.

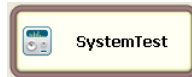
Chapter 9

Menu [System Test] in detail

9.1 System Test in overview.....	2
9.2 System Test in detail.....	2
9.2.1 [System Test] dialog [Priming] section in detail.....	3
9.2.2 [System Test] dialog [System test] section in detail	4
9.2.3 [System Test] dialog exiting, confirmation, and information	5
9.3 Placing Light Check on the analyzer	7

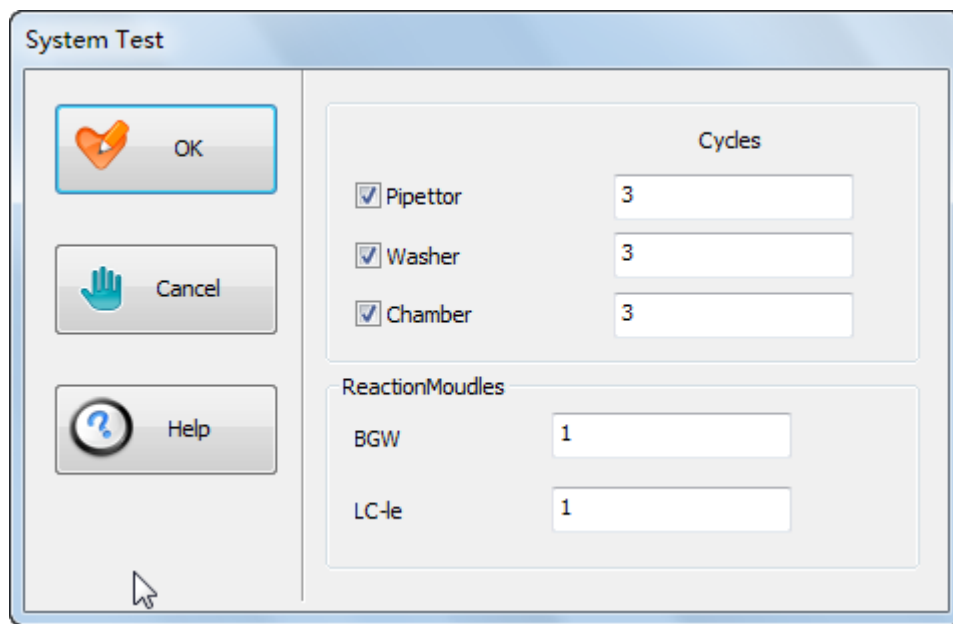
9.1 System Test in overview

The <System Test> icon is used to prime the analyzer, and run a standard diagnostics test on the analyzer to ensure that the components of the analyzer are working properly before any real tests are run. These diagnostics tests are known as “System tests” and must be run each working day prior to normal operation of the analyzer.]



By pressing the **SystemTest** icon from the main menu it is possible to access the <System Test> dialog. (See Fig. 9.1-1 System Test)

Fig. 9.1-1: System Test



	<p>This section is for entering the number of priming cycles wished for each fluidic system.</p>	<p>9.2.1 System Test<Prime cycles> in detail</p>
	<p>This section is for entering the number of each type of analyzer diagnostic test (System test).</p>	<p>9.2.2 < Reaction Modules> in detail</p>
	<p>Accepts the input and allows starting the system test.</p>	<p>9.2.3 <OK> icon in detail</p>
	<p>Discards the input and closes the dialog without starting the system test.</p>	



For keeping safety of the diagnostic results received by the MAGLUMI Diagnostic System, it is necessary to perform System Test every day and after each exchange of starter reagents. [053]

9.2 System Test in detail

Upon entering the <System Test> by pressing the appropriate icon from the main menu, the [System test] dialog opens. This dialog contains three major sections.

Priming section

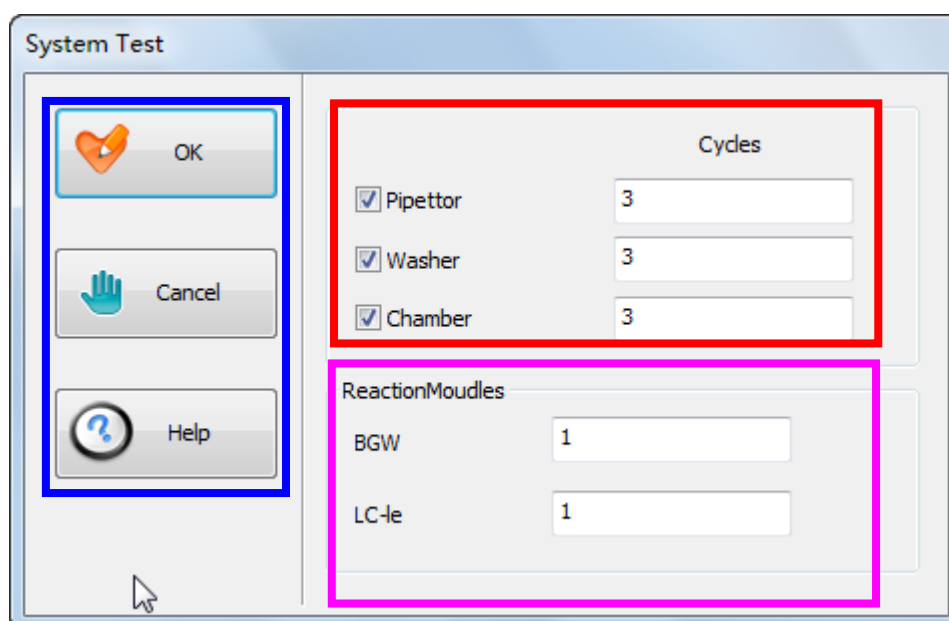
This section is [Cycles] for settings of individual priming areas. See Fig 9.2.1.

System test section

The section [Reaction modules] is for settings of individual system test. See 9.2.2.

Confirmation section

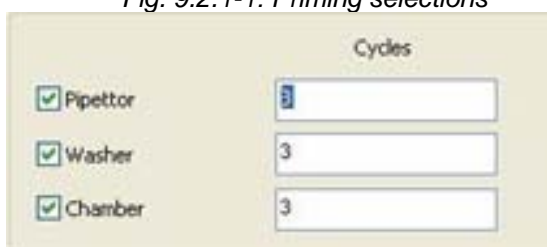
This section is **exiting, confirmation, and information**. See 9.2.3.



9.2.1 [System Test] dialog [Priming] section in detail

The priming section allows the user to select how many cycles of which fluidic system should be primed. The priming section may run independently of the [System test] section.

Fig. 9.2.1-1: Priming selections



It contains three different systems.

Pipettor:

The pipettor selection controls the priming for the pipetting needles, diluters, syringes, and tubing. **1 cycle = 6 ml of Wash/System liquid.** The user should prime the pipettor as seen in fig. 9.2.1-1, at the beginning

of each workday. When wash/system liquid has been replaced, see chapter 13.

- Washer:** The washer selection controls the priming for the wash pumps, wash needles, and tubing.
1 cycle = 7.2 ml of Wash/System liquid
 The user should prime the washer as seen in fig. 9.2.1-1, at the beginning of each workday. When wash/system liquid has been replaced, see chapter 13
- Chamber:** The chamber selection controls the priming for the reading chamber, injection pumps, and tubing.
1 cycle = 1.2 ml of Starter reagent liquid (per bottle). The user should prime the chamber as seen in fig.9.2.1-1, at the beginning of each workday. When starter reagent liquid has been replaced, see chapter13.

Ensure that all liquids are sufficient for the number of requested cycles.

9.2.2 [System Test] dialog [System test] section in detail

The system test section allows the user to select how many runs of which test should be executed. The system test section may run independently of the “Priming” section.

Fig. 9.2.2-1: System test selection

ReactionMoudles	
BGW	1
LC-le	1

It contains three different systems.

BGW: (Back Ground Wash) result range of “**200 – 1200 RLU’s**”.

This analyzer diagnostic test tests the effectiveness of the washing element and the lowest range of the reading chamber. This test is completed using the existing system fluidics. No extra additions are necessary to start this test.

LC-le: (Light Check left) result range of “**400000 – 650000 RLU’s**”. This analyzer diagnostic test tests the accuracy of the left pipetting needle. This test is completed using an external light check.

Table 9.2.2-1: System Test verification table

System test	Ranges	Max RLU CV's	Left/Right Differences
BGW	200 – 1200 RLU's	< 10%	-
Light Check	400,000 –650,000 RLU's	< 3%	< 3%

Table 9.2.2-2: LC verification table

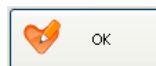
If the mean of LC-le & LC-ri is:		The values below apply for the given ranges & should not exceed:
Greater than	But less than	
400000	450000	25000
450000	500000	26000
500000	550000	27000
550000	600000	28000
600000	650000	29000

9.2.3 [System Test] dialog exiting, confirmation, and information

The saving and canceling section of the **[System Test]** dialog contains the buttons to either:

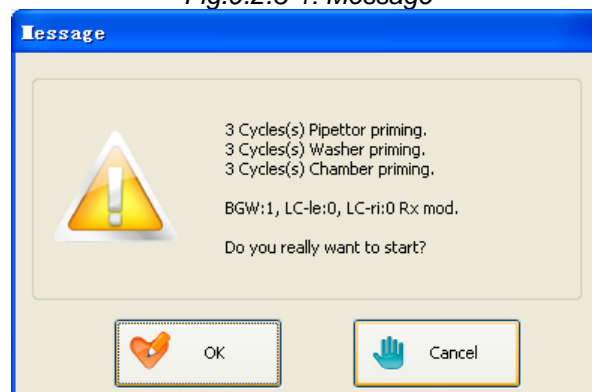
- 1) **<OK>** = Confirm the entries and start the system test.
- 2) **<Cancel>** = Exit the dialog without saving any changes that were made or starting any priming or system tests.

The **<Help>** icon is not active.



Pressing the icon confirms the **[System test]** dialog with **<OK>**, the **[Message]** dialog with a list of the entered settings is displayed (see Fig. 9.2.3-2)

Fig.9.2.3-1: Message



<OK> must be pressed a second time in order to start the system test.

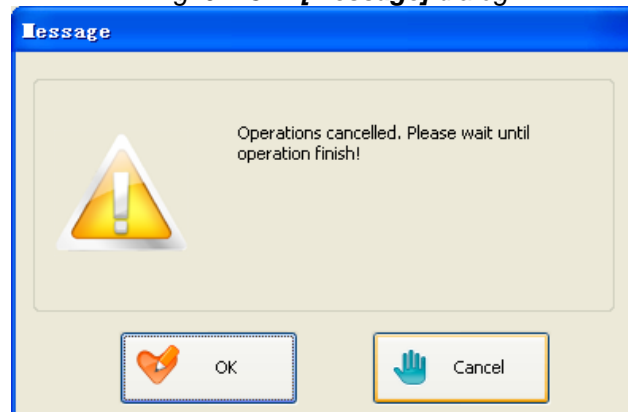


Uncapped Light check vials must be placed in 1 or 2 track in the Sample Area before starting the system test.

When attempting to enter **<System test>** from the main menu while the analyzer is active, the system start dialog appears informing the user of the information contained in the dialog below.

See figure 9.2.3-2: **[Message]** dialog

Fig. 9.2.3-2: **[Message]** dialog



9.3 Placing Light Check on the analyzer

The light check is a SNIBE product, manufactured specifically for usage of testing the pipetting functionality on the MAGLUMI® analyzer.

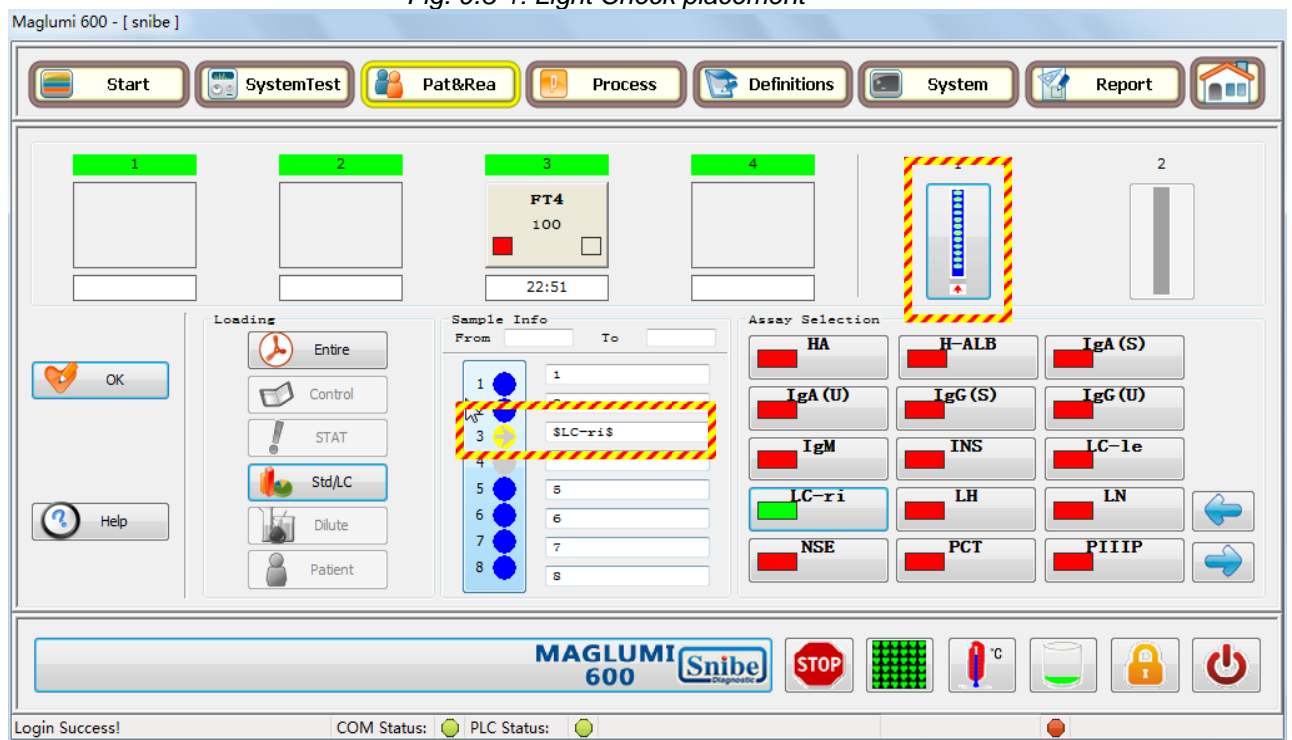
Preparation of the MAGLUMI® Light Check should be accomplished according to chapter 13 section 13.2.4.

Insertion of the MAGLUMI® Light Check should be accomplished according to chapter 15 section 15.3.3.

The “L” type sample rack containing light check can be inserted only in tracks (lanes) 11, or 12 of the analyzer patient area.

After proper insertion the MAGLUMI® Light Check will be automatically recognized and will appear in the **[Sample Loading]** dialog as shown in figure 9.3-1: Light Check placement.

Fig. 9.3-1: Light Check placement



Manually programming of the Light Check on the analyzer


The light check is normally automatically recognized on the analyzer.

There may however be cases whereas the barcode of the light check may be damaged and not readable. In these cases, the light check must be programmed manually. This is accomplished as described below.

Insertion of the MAGLUMI® Light Check should be accomplished according to chapter 15 section 15.3.3.

If the light check has not been recognized the sample rack will appear as a blank rack in the **[Sample Loading]** section. Remove the sample rack and reinsert it again. If the sample rack is still being shown as empty in the **[Sample Loading]** section, follow the steps below.

1. Insert the sample rack
2. Select the position in the sample rack where the light check is located.

3. Press the icon  and the arrow (only the arrow) where the light check should be located will turn yellow. See figure 9.3.1-1: LC programming.

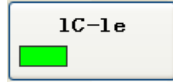
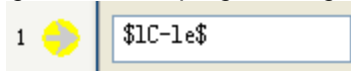
4. From the assay list on the right, select the icon  and the name will appear in the **[Sample ID]** field. Then deselect the same icon to cancel it in the working list. See figure 9.3.1-1: LC programming.

Fig. 9.3.1-1: LC programming



5. Press TAB or ENTER to confirm and leave the field.

Select **<System Test>** in the main menu to bring up the **[System Test]** dialog box. The system test must always be performed before starting the routine.

Take the set values of the Background and Light Check measurements for checking your results from the instruction of the MAGLUMI[®] Light Check.

BGW: 200–1200 RLU;
 LC-le/LC-ri: 400,000 –650,000 RLU;
 (please refer to the instruction for the individual expected values for the Light Check reagent)

- Deviation between LC-le and LC-ri should be within 5%;
- LC: CV% ≤ 3%;
- BGW: CV% ≤ 10%;



For keeping safety of the diagnostic results received by the MAGLUMI[®] Diagnostic System, it is necessary to perform the Light Check only with opened LC vials placed in sample-racks(1 or 2 lanes).

Chapter 10

Menu [Report] in detail

10.1 Report in overview	2
10.2 <Journal> icon in detail	3
10.2.1 [Journal] icon <Sort> in detail.....	4
10.2.2 [Journal] icon <Print> in detail.....	5
10.2.3 [Journal] icon <Recalc.> in detail	6
10.2.4 [Journal] icon <Online> in detail.....	7
10.2.5 [Journal] icon <Edit> in detail	8
10.2.6 [Journal] icon <Delete> in detail	9
10.2.7 [Journal] icon <Valid> in detail	10
10.2.8 [Journal] icon < Remeasure > in detail	11
10.3 <Valid> icon in detail.....	12
10.3.1 [Valid] icon, <Sort> in detail	13
10.3.2 [Valid] icon <Online> in detail	14
10.3.3 [Valid] icon <View> in detail	15
10.3.4 [Valid] icon <Delete> in detail.....	16
10.3.5 [Valid] icon <Print> in detail	17
10.4 [Calibrator] icon in detail	18
10.4.1 [Calibrator] icon <Sort> in detail.....	19
10.4.2 [Calibrator] icon <Online> in detail.....	20
10.4.3 [Calibrator] icon <View> in detail.....	21
10.4.4 [Calibrator] icon <Delete> in detail	22
10.4.5 [Calibrator] icon <Print> in detail.....	22
10.5 [Control] icon in detail	24
10.5.1 [Control] icon <Sort> in detail.....	25
10.5.2 [Control] icon <Online> in detail.....	26
10.5.3 [Control] icon <View> in detail.....	27
10.5.4 [Control] icon <Delete> in detail	28
10.5.5 [Control] icon <Print> in detail.....	28
10.6 [System Test] icon in detail	30
10.7 [QC] icon in detail.....	31
10.8 [Report] icon in detail	31

10.1 Report in overview




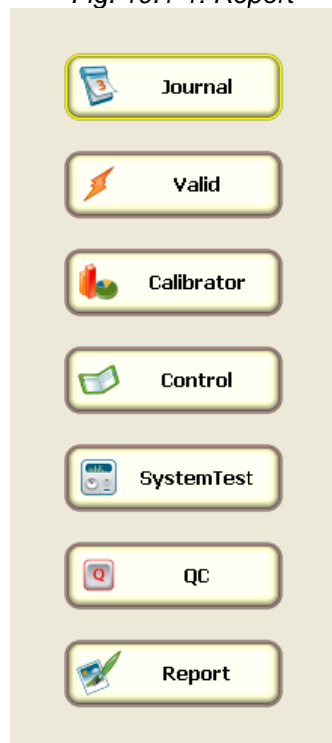







By pressing the button  from the main menu the **[Report]** interface appears on the left of the monitor (see Fig. 10.1-1Report).

Fig. 10.1-1: Report



 Journal	Clicking on the button opens the interface [Journal]	10.2 <Journal> icon in detail
 Valid	Clicking on the button opens the interface [Valid]	10.3 <Valid> icon in detail
 Calibrator	Clicking on the button opens the interface [Calibrator]	10.4 <Calibrator>icon in detail
 Control	Clicking on the button opens the interface [Control]	10.5 <Control>icon in detail
 SystemTest	Clicking on the button opens the interface [System Test]	10.6 <SystemTest> icon in detail
 QC	Clicking on the button runs the external quality control program	10.7 <QC> icon in detail
 Report	Clicking on the button runs the patient report	10.8 <Report> icon in detail

10.2 <Journal> icon in detail



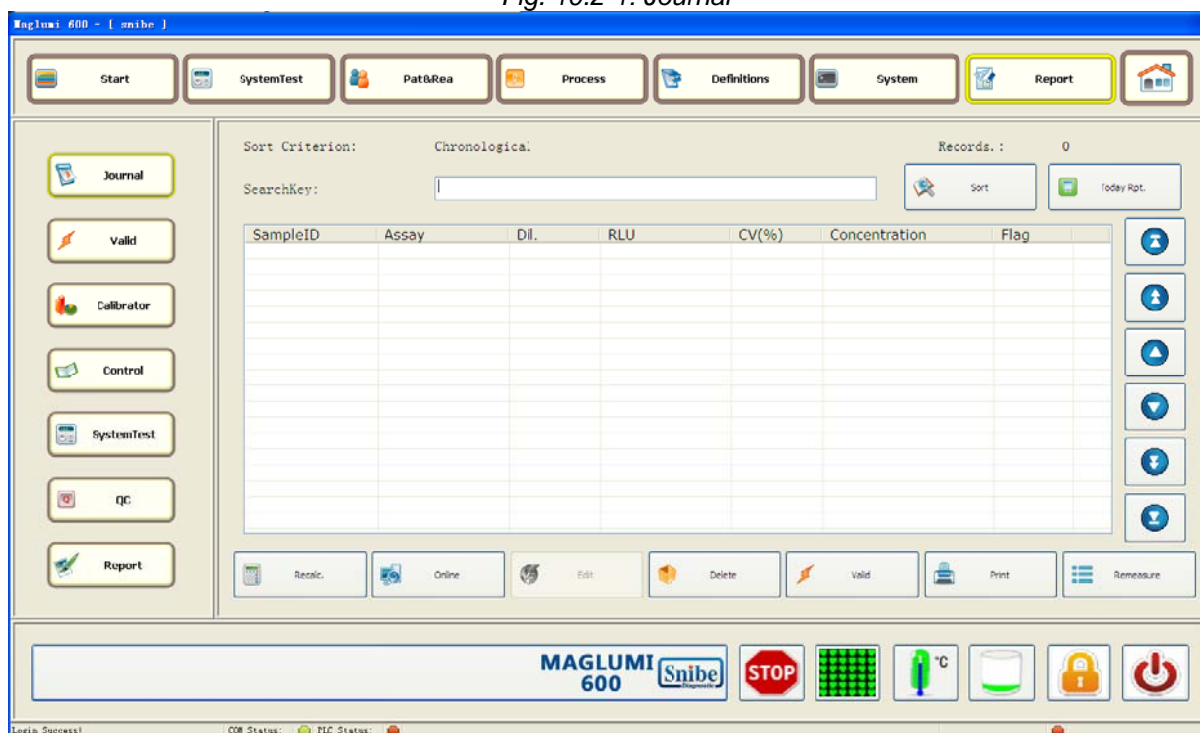

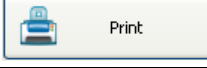
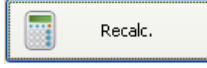


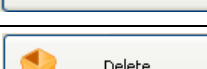
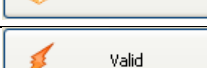
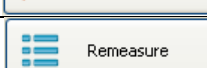






Select **<Report>**  in the main menu to bring up the **[Report]** interface and then press **[Journal]**  to open the **[Journal]** interface (see Fig. 10.2-1 Journal)

Fig. 10.2-1: Journal



<SearchKey>	Entry field for a self-selected search key e.g. assay. All measuring results of this assay are then placed at the beginning of the list of measuring results	
 Sort	Display of the selected sort criterion.	10.2.1 [Journal], icon <Sort> in detail
 Print	Opens the Printout Selection Dialog, which allows choosing the results to be printed out	10.2.2 [Journal], icon <Print> In detail
 Recalc.	Recalculation of measured working samples using the last validated working curve of the same parameter and lot	10.2.3 [Journal], icon <Recalc> in detail
 Online	Opens the [Online Selection Dialog], which allows choosing the results to be sent online to the host computer.	10.2.4 [Journal], icon <Online> in detail
 Edit	Opens the Detailed Sample Result dialog- validated- and allows viewing the detailed information about the validated results.	10.2.5 [Journal], icon <View> in detail
 Delete	Opens the Selection Dialog, which allows choosing the results to be deleted.	10.2.6 [Journal], icon <Delete> in detail
 Valid	To validate a result.	10.2.7 [Journal], icon <Valid.> in detail
 Remeasure	To do a selected sample again	10.2.8 [Journal], icon <Remeasure> in detail

		To view the results one by one	
		To view the results page by page	
		To go to the first & last page	

10.2.1 [Journal] icon <Sort> in detail


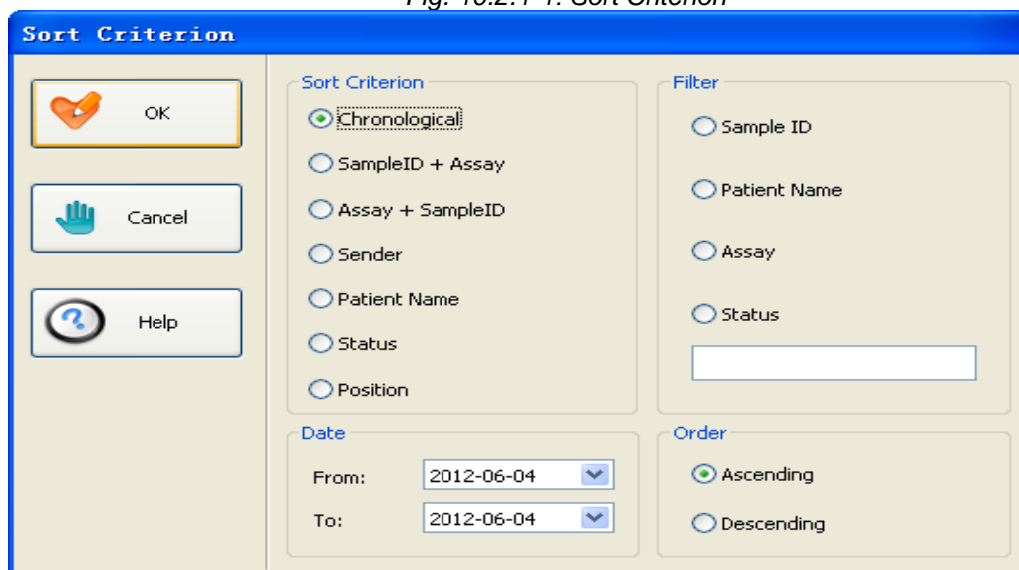
Pressing the icon  **Sort** in the [Journal] interface to open the [Sort Criterion] dialog. (See Fig. 10.2.1-1 Sort Criterion)

Fig. 10.2.1-1: Sort Criterion



[Sort Criterion]

Display of the selected sort criterion:

(Chronological) represents the chronological sequence in which the measuring results were obtained.

(Sample ID + Assay) represents the sequence of results sorted according to the first criterion the sample identification number (ascending or descending numerical sequence) and then according the assay (alphabetical).

(Assay + Sample ID) represents the sequence of results sorted according to assay (alphabetical) and then according sample identification number (ascending or descending numerical sequence).

(Sender) represents the sequence of measuring results sorted according to sender.

(Patient Name) represents the sequence of measuring results sorted according to patient names (alphabetically)

(Status) represents the sequence of measuring results sorted according to their status (placed, to-do, active, done)

(Position) represents the sequence of measuring results sorted according to position of the samples in the sample station

[Filter]

A filter can be applied over all measuring results and by this means all results, e.g. with a special sample number, can be selected with a special assay. Enter a filter for this purpose in the entry field. The filter options are then activated and can be selected.

[Order]

It is possible to sort the results in a **(Ascending)** or **(Descending)** Order.

[Date]

It is possible to sort the results by the date of the results.

10.2.2 [Journal] icon <Print> in detail


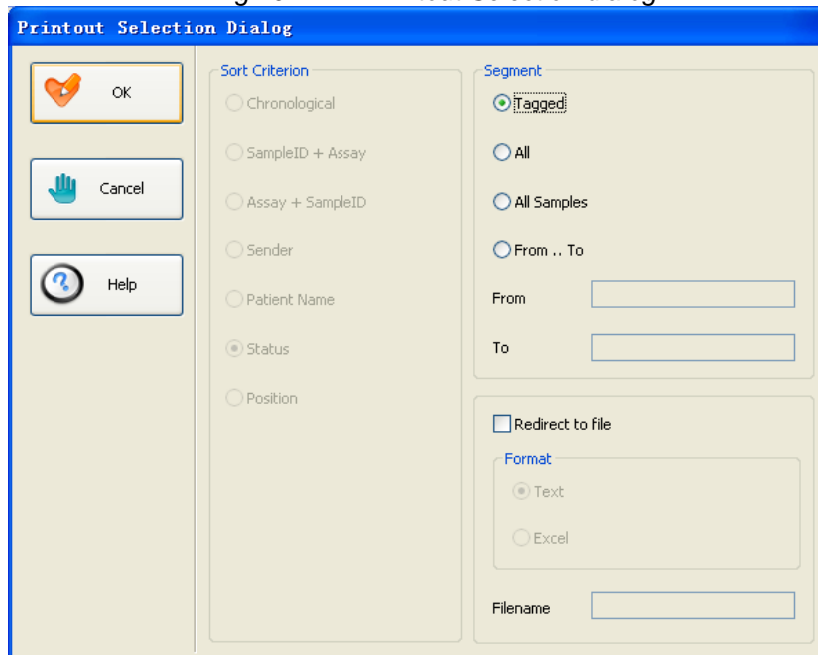
Pressing the icon  will open the **[Printout Selection Dialog]**. (See fig.10.2.2-1).

Fig.10.2.2-1: Printout Selection dialog

**[Sort Criterion]**

Display of the sort criterion selected for printout as described in **<Sort>**

[Segment]

Indication of the segment to be printed.

(Tagged) The segment to be printed consists of tagged results. For tagging a result (a line) press the key **<F7>**. Pressing **<F7>** again cancels the tagging. Tagged results are indicated at the end of the line with " * "

(All) All results

(All Samples) All sample results

(From...To) Range indication. On selecting this option, the entry fields are activated for entry of the beginning and end of the range to be printed

[Redirect to file]

Saving the measuring results as a file on a data storage device. (I.e. floppy disk, USB flash stick or hard drive)

(Format) can be <Text> or <Excel>

10.2.3 [Journal] icon <Recalc.> in detail

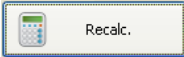
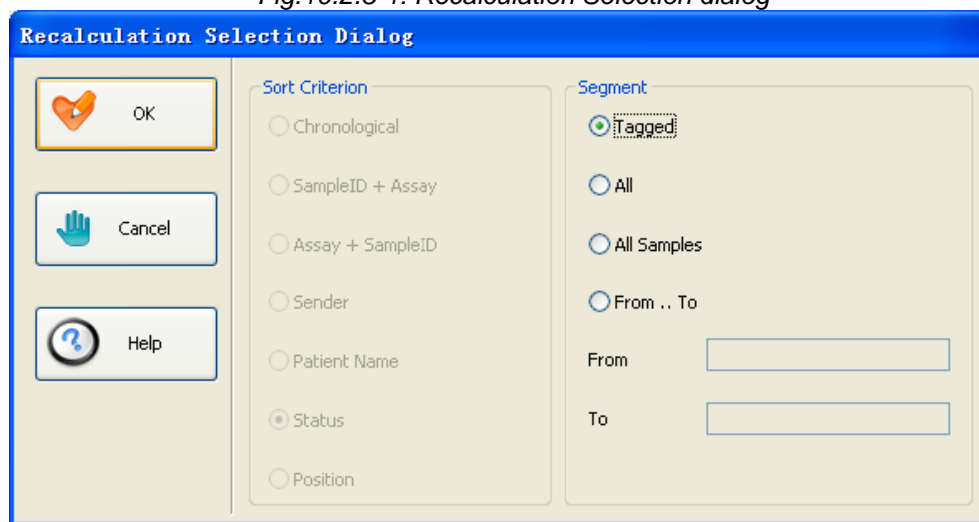
Press the icon  will open the **[Recalculation Selection Dialog]**. (See Fig.10.2.3-1).

Fig.10.2.3-1: Recalculation Selection dialog



[Sort Criterion]

Display of the sort criterion selected as described in <Sort>.

[Segment]

Indication of the segment to be recalculated.

(Tagged) The segment to be recalculated consists of tagged results. For tagging a result (a line) press the key <F7>. Pressing <F7> again cancels the tagging. Tagged results are indicated on the end of the line with “ * ”

(All) All results

(All Samples) All sample results

(From...To) Range indication. On selecting this option, the entry fields are activated for entry of the beginning and end of the range to be recalculated

10.2.4 [Journal] icon <Online> in detail

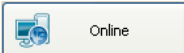
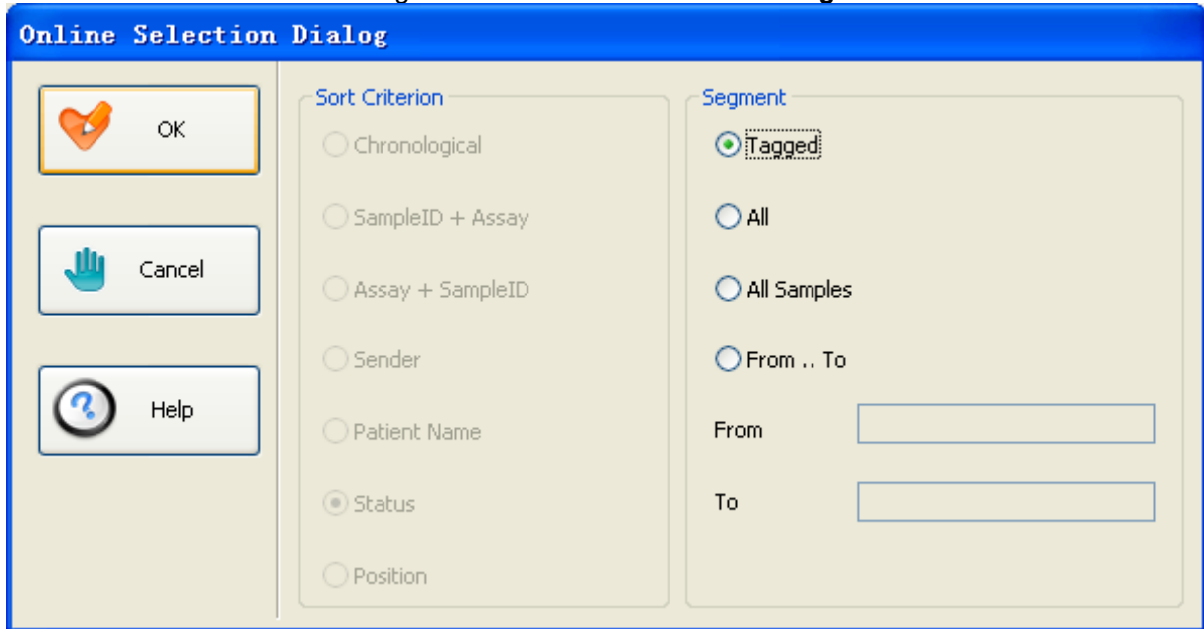

The icon  in the [Journal] dialog opens the [Online Selection Dialog]. (See fig.10.2.4-1).

Fig. 10.2.4-1: Online Selection Dialog



In this dialog, the software requests all test orders from the host computer.

The <OK> icon is not available while the transmission is in process. After completion of the transmission, confirming with  exits the dialog to start the upload process.

10.2.5 [Journal] icon <Edit> in detail




Press the icon  will open the [Detailed Sample Result] dialog. (See Fig. 10.2.5-1)

Fig. 10.2.5-1: Detailed Sample Result

This dialog displays:

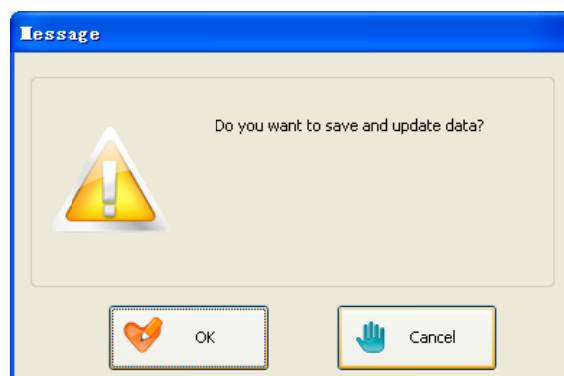
- [Patient]** Displays all inputs of the patients entered in the [Sample] interface, icon <Patient>
- [Sender]** Displays all inputs for the patient entered in the [Definition Functions] dialog, icon <Sender>
- [Sample]** Displays the sample ID, the position of the sample e.g. 03/04 means rack 03, sample position in the rack 04, the status and the time of the result.
- [Results]** Displays the abbreviation, single or mean RLU's, single or mean concentration, the Qual. Label, RLU and time of the measuring result. (User could change the RLU result manually if necessary)
- [Integral]** Displays the integral information, Kit-No, Lot-No, Master Curve- ID
- [Dilution]** Displays the dilution, if defined
- [Flags]** Displays all flags for the sample (similar to 10.3.3-2 Table Flag List).

[Journal -> Detailed Sample Result] -> Change RLU

Fig. 10.2.5.1-1: change RLU value

The screenshot shows a dialog box titled "Results:(FT4)". It contains two columns: "RLU" and "Mean RLU". Both columns have a text input field containing the value "223848". Below each input field are two empty text input fields, suggesting a list or multiple entries.

It allows editing RLU results and press <OK> in the pop-up dialog to save the results. Otherwise press <Cancel> to leave without saving.

**10.2.6 [Journal] icon <Delete> in detail**


Press the icon  Delete in the **[Journal]** dialog to open the **[Delete Selection Dialog]**. (See fig.10.2.6-1).

Fig. 10.2.6-1: Selection Dialog

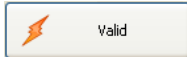
The screenshot shows the "Delete Selection Dialog" with a blue title bar. On the left side, there are three buttons: "OK" with a red heart icon, "Cancel" with a blue hand icon, and "Help" with a question mark icon. The main area is divided into two sections: "Sort Criterion" and "Segment".

Sort Criterion: A list of radio buttons with "Status" selected. The options are: Chronological, SampleID + Assay, Assay + SampleID, Sender, Patient Name, Status, and Position.

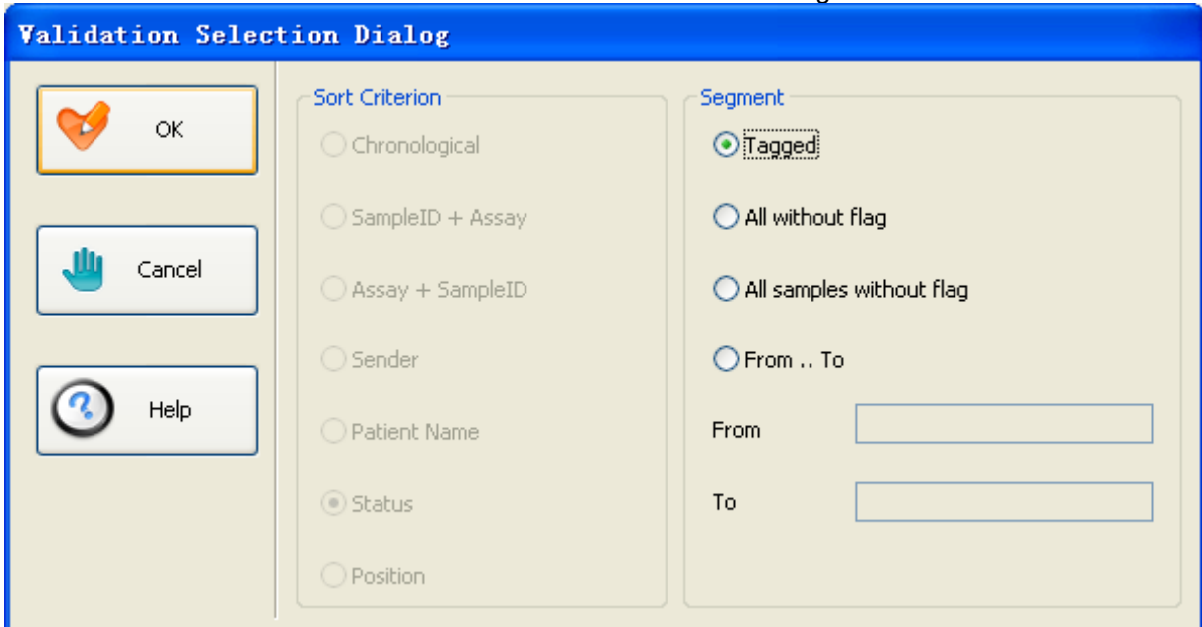
Segment: A list of radio buttons with "Tagged" selected. The options are: Tagged, All, All Samples, and From .. To. Below this, there are two text input fields labeled "From" and "To".

In this dialog only the **[Segment]** area is available for the user and indicates which measuring results should be deleted.

10.2.7 [Journal] icon <Valid> in detail

The icon  will open the **[Validation Selection Dialog]**. (See fig.10.2.7-1).

10.2.7-1: Validation Selection dialog


[Sort Criterion]

Display the sort criterion selected as described in **<Sort>**. Not accessible in this dialog

[Segment]

Indication of the segment to be validated

(Tagged) The segment to be validated consists of tagged results. For tagging a result (a line), press the key **<F7>**. Pressing **<F7>** again deletes the tagging. Tagged results are indicated at the beginning and on the end of the line with “ * ”

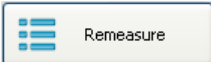
(All without flag) All results without flag

(All Samples without flag) All sample results without flag

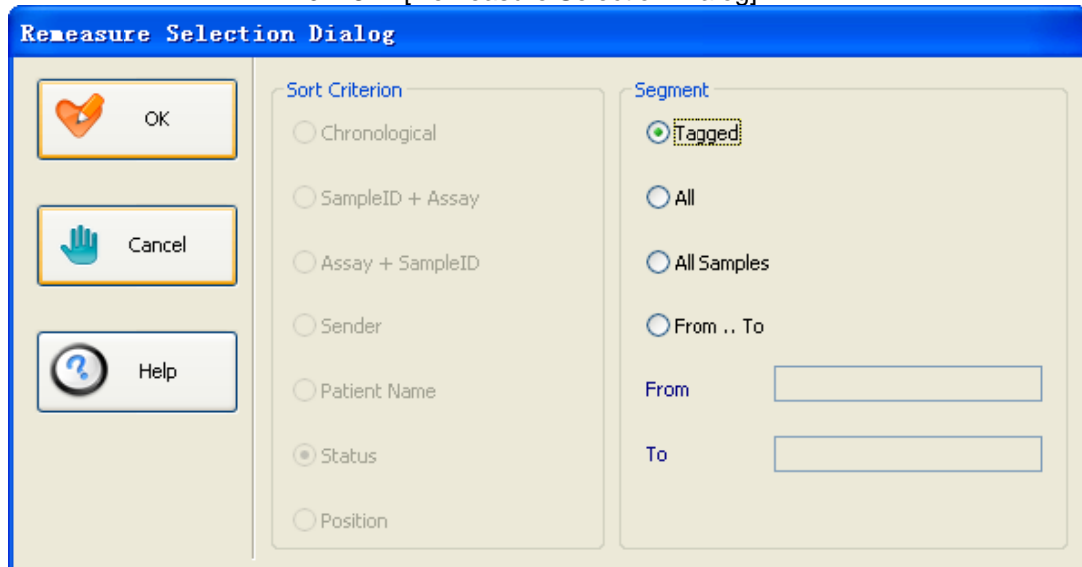
Remark: The validation of the complete **[Journal]** is only possible if no result is flagged.

(From...To) Range indication. Upon selecting this option, the entry fields are activated for entry of the beginning and end of the range to be recalculated.

10.2.8 [Journal] icon <Remeasure> in detail

Press the icon  will open the **[Remeasure Selection Dialog]**. (See fig.10.2.8-1).

10.2.8-1: [Remeasure Selection Dialog]

**[Sort Criterion]**

Display the sort criterion selected as described in **<Sort>**. Not accessible in this dialog

[Segment]

Indication of the segment to be validated

(Tagged) The segment to be validated consists of tagged results. For tagging a result (a line), press the key **<F7>**. Pressing **<F7>** again deletes the tagging. Tagged results are indicated at the beginning and on the end of the line with “ * ”

(All without flag) All results without flag

(All Samples without flag) All sample results without flag

Remark: The validation of the complete **[Journal]** is only possible if no result is flagged.

(From...To) Range indication. Upon selecting this option, the entry fields are activated for entry of the beginning and end of the range to be recalculated.

CAUTION

When selecting a sample you want to remeasure, make sure that the position of the sample in the sample area has not been changed (the sample is in the same rack and the same track)!

10.3 <Valid> icon in detail

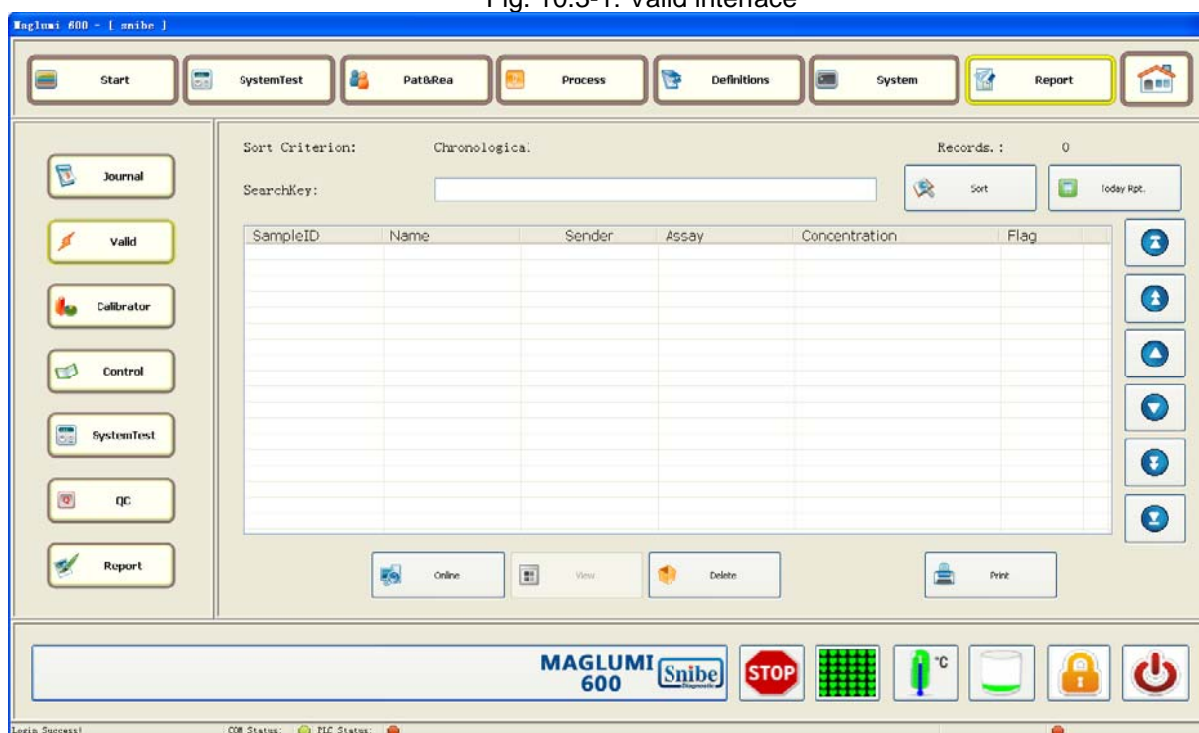







For maintaining safety of diagnostic results received by the MAGLUMI Diagnostic System ,it is recommended to validate all results in the validation menu (if available) by the responsible persons before release.










Select <Report> in the main menu and then press **Valid** to open the **[Valid] interface** (see fig. 10.3-1 Valid interface).

Fig. 10.3-1: Valid interface



<Searchkey>	Entry field for a self-selected search key e.g. assay. All measuring results of this assay are then placed at the beginning of the list of measuring results	
 Sort	Display of the selected sort criterion.	10.3.1[Valid], icon <Sort> in detail
 Today Rpt.	Display all the results done within today	
 Online	Opens the [Online Selection Dialog] which allows choosing the results to be sent online to the host computer.	10.3.2 [Valid], icon<Online> in detail
 View	Opens the Detailed Sample Result dialog-validated- and allows viewing the detailed information about the validated results.	10.3.3 [Valid], icon <View> in detail
 Delete	Opens the Selection Dialog, which allows choosing the results to be deleted.	10.3.4 [Valid], icon <Delete> in detail

 Print	Opens the Printout Selection Dialog which allows choosing the results to be printed out	10.3.5 [Valid], icon <Print>In detail
 	To view the results one by one	
 	To view the results page by page	
 	To go to first & last page	

10.3.1 [Valid] icon, <Sort> in detail

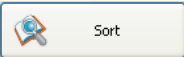
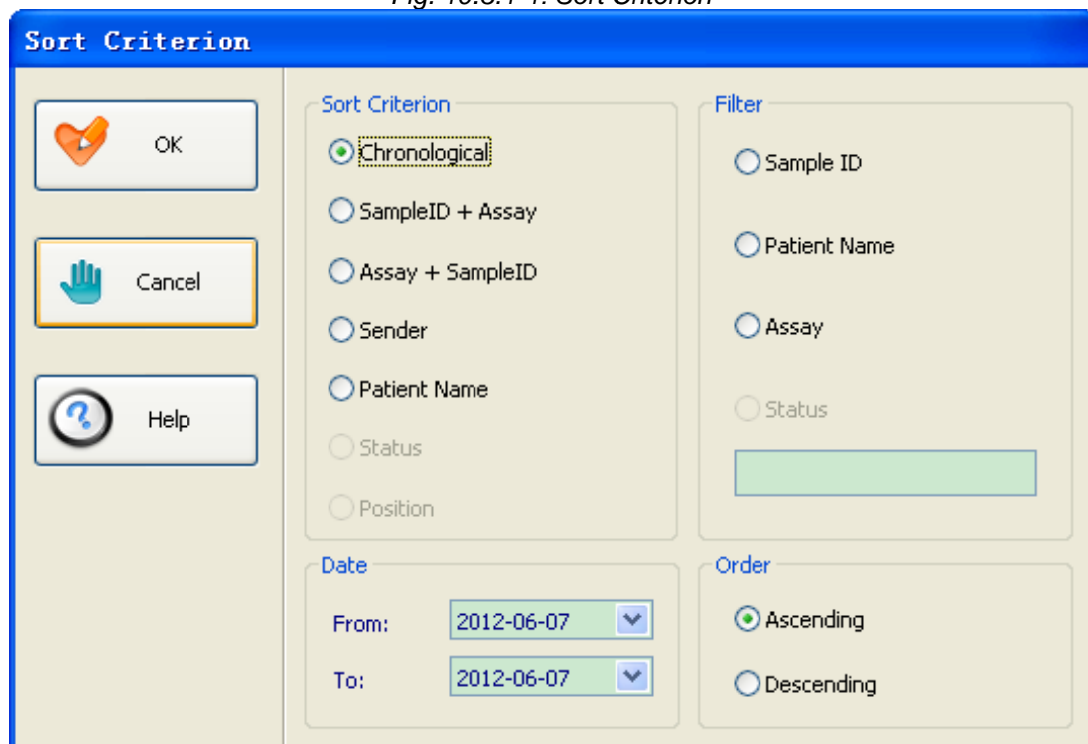
Pressing the icon  in the <Valid> interface to open the dialog [Sort Criterion]. (See Fig. 10.3.1-1 Sort Criterion)

Fig. 10.3.1-1: Sort Criterion



[Sort Criterion]

Display of the selected sort criterion:

(Chronological)

represents the chronological sequence in which the measuring results were obtained

(Sample ID + Assay)

represents the sequence of results sorted according to the first criterion the sample identification number (ascending or descending numerical sequence) and then according the assay (alphabetical).

(Assay + Sample ID)	represents the sequence of results sorted according to assay (alphabetical) and then according sample identification number (ascending or descending numerical sequence).
(Sender)	represents the sequence of measuring results sorted according to sender
(Patient Name)	represents the sequence of measuring results sorted according to patient names (alphabetical)
[Filter]	A filter can be applied over all measuring results and by this means all results, e.g. with a special sample number, can be selected with a special assay. Enter a filter for this purpose in the entry field. The filter options are then activated and can be selected.
[Order]	It is possible to sort the results in “ Ascending ” or “ Descending ” order.
[Date]	represents the sort criterion time from begin to the end.

10.3.2 [Valid] icon <Online> in detail


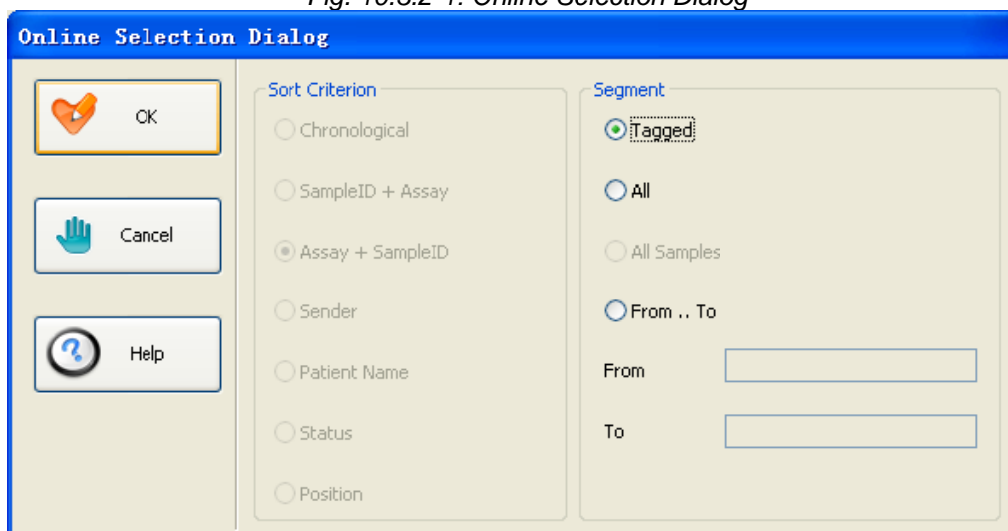
The icon  in the **[Valid]** interface to open the **[Online Selection Dialog]**. (See Fig.10.3.2-1.)

Fig. 10.3.2-1: Online Selection Dialog



In this dialog only the **[Segment]** area is available for the user and indicates which measuring results should be transferred to the host computer.

Confirming the selection with  starts the upload process.

10.3.3 [Valid] icon <View> in detail


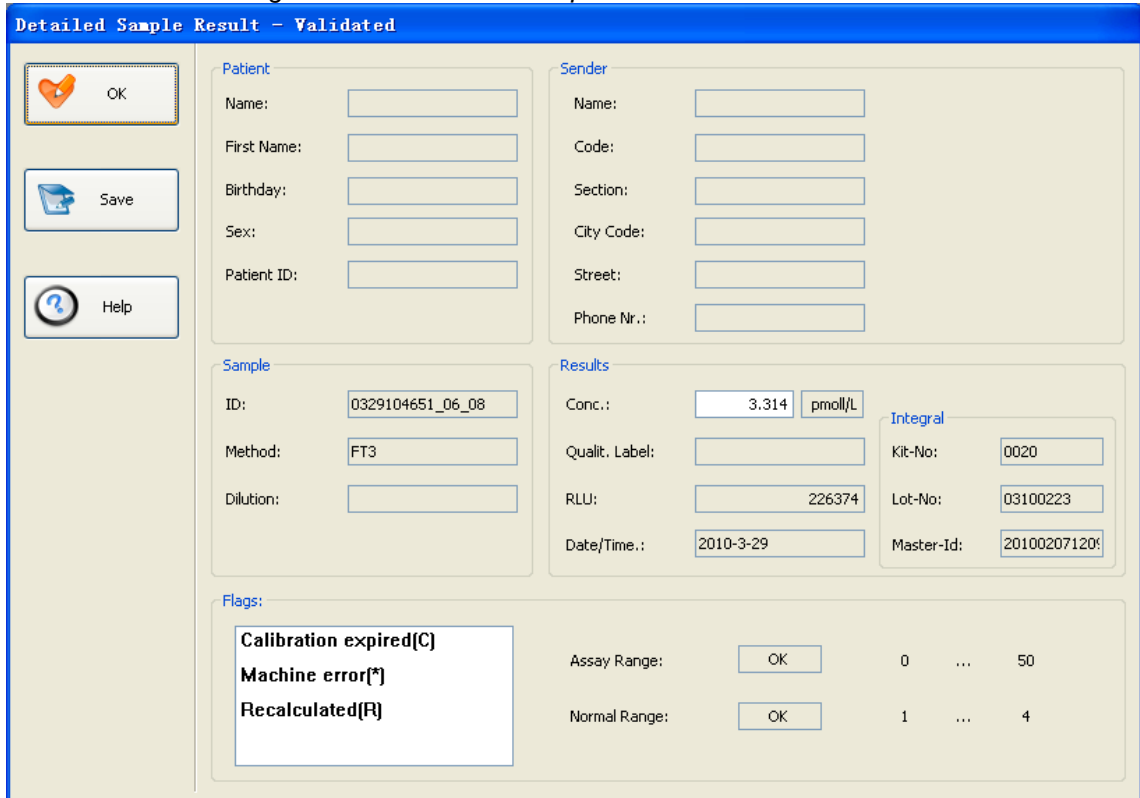
Press the icon  will open the [Detailed Sample Result-Validated] dialog. (See Fig.10.3.3-1)

Fig. 10.3.3-1: Detailed Sample Result -Validated



This dialog displays:

[Patient]	Displays all inputs for the patient entered in [Patient]
[Sender]	Displays all inputs for the patient entered in the [Definition Functions Dialog] icon <Sender>
[Sample]	Displays the sample ID, the assay abbreviation and the dilution.
[Results]	Displays the concentration, the Qual. Label, RLU and time of the measuring result.
[Integral]	Displays the integral information, Kit-No, Lot-No., Master curve ID
[Flags]	Displays all flags for the sample. (See Fig.10.3.3-2 Table Flag List)

The following table shows the possible flags sorted according to their priority:

Fig. 10.3.3-2: Table flag list

Priority	Flag	Description
3	*	Machine error, for example pipetting errors or measurement errors. Within the daily lab journal, clicking on the Button <Edit> opens the dialog <Detailed Sample Result> , where detailed information about the result can be viewed.
4	E	The stability date of the reagent integral used for this result is exceeded
5	C	The validity of the calibration curve used for this result is exceeded (calibration expired).
11	R	The result was recalculated with the option <Recalc.> in the daily journal
15	> / <	The result is outside the normal range (only for patient results).
	>> / <<	The result is outside the assay range (only for patient results)

10.3.4 [Valid] icon <Delete> in detail

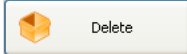
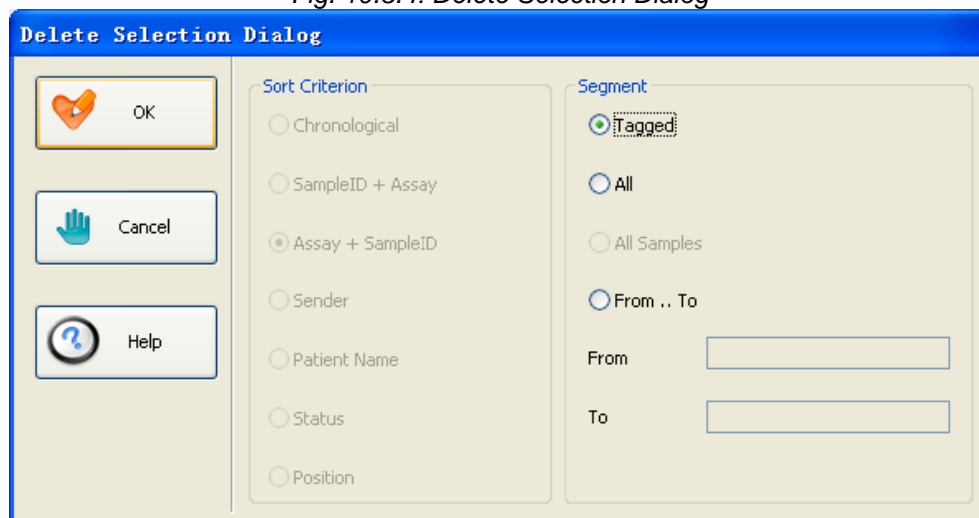
The icon  in the **[Valid]** dialog opens the **[Delete Selection Dialog]**. (See Fig.10.3.4)

Fig. 10.3.4: Delete Selection Dialog



In this dialog only the **[Segment]** area is available for the user and indicates which measuring results should be deleted.

10.3.5 [Valid] icon <Print> in detail


The icon  will open the [Printout Selection Dialog]. (See Fig. 10.3.5-1)

Fig. 10.3.5-1: Printout Selection Dialog

[Sort Criterion]

Display of the sort criterion selected for printout as described in <Sort> (section 10.3.1).

[Segment]

Indication of the segment to be printed.

(Tagged) The segment to be printed consists of tagged results. For tagging a result (a line) press the key <F7>. Pressing <F7> again cancels the tagging. Tagged results are indicated on the end of the line with “ * ”

(All) All results

What is all results? The different behaviors must be described.

(From...To) Range indication. On selecting this option, the entry fields are activated for entry of the beginning and end of the range to be printed.

[Redirect to file]

Saving the measuring results as a file on a data storage device. (i.e. floppy disk, USB flash stick)

(Format) can be <Text>, <Excel>

CAUTION

When printing results in a dialog other than the "Valid Journal", there is a remark on the printed list that states that the printed data has not been validated and could be compromised.

10.4 [Calibrator] icon in detail


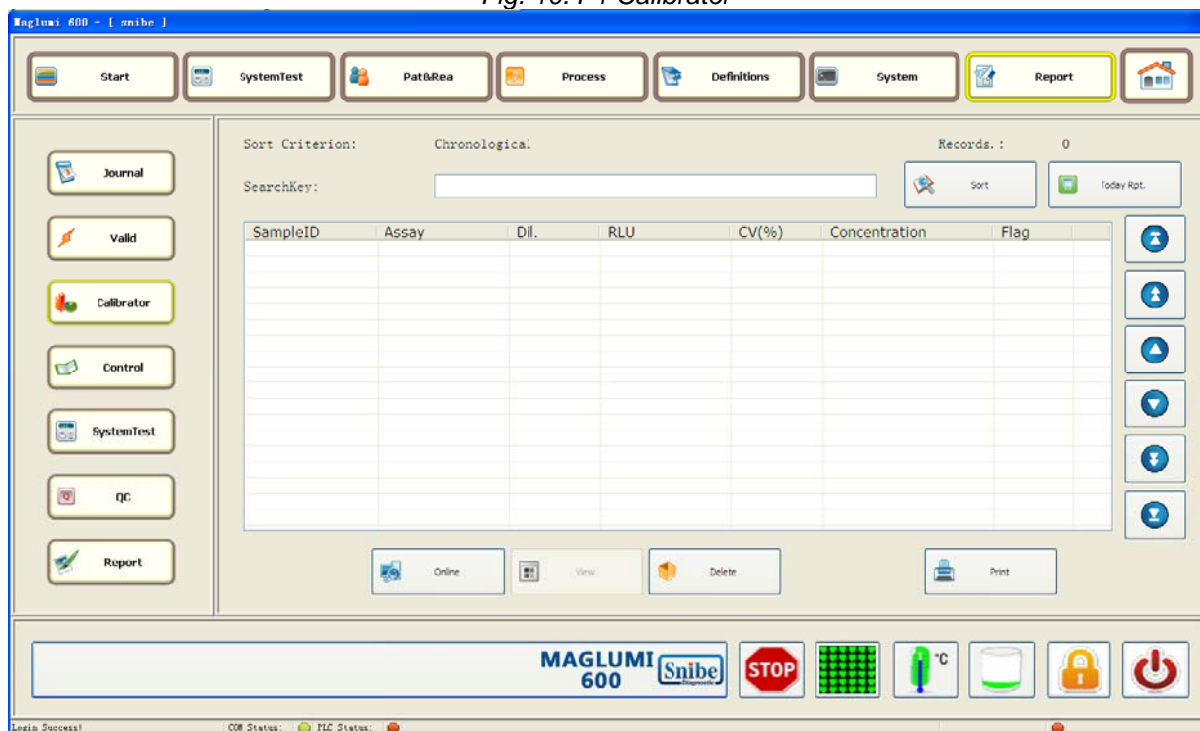








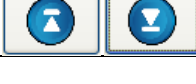
Select **<Report>** in the main menu and then press  to open the **[Calibrator]** interface (see fig. 10.4-1 Calibrator).

Fig. 10.4-1 Calibrator



<SearchKey>	Entry field for a self-selected search key e.g. assay. All measuring results of this assay are then placed at the beginning of the list of measuring results	
 Sort	Display of the selected sort criterion.	10.4.1 [Calibrator] icon <Sort> in detail
 Today Rpt.	Display all the calibration results done today	
 Online	Opens the [Online Selection Dialog] which allows choosing the results to be sent online to the host computer.	10.4.2 [Calibrator] icon <Online> in detail
 View	Opens the Detailed Calibrator Result dialog and allows viewing the detailed information about the Calibrator results.	10.4.3 [Calibrator] icon <View> in detail
 Delete	Opens the Delete Selection Dialog which allows choosing the Calibrator results to be deleted.	10.4.4 [[Calibrator] icon <Delete> in detail
 Print	Opens the Printout Selection Dialog which allows choosing the results to be printed out.	10.4.5 [Calibrator] icon <Print>In detail
	To view the results one by one	
	To view the results page by page	
	To go to first & last page	

10.4.1 [Calibrator] icon <Sort> in detail

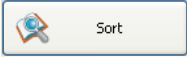
Press the icon  in the < **Calibrator** > interface to open the dialog [**Sort Criterion**]. (See Fig. 10.4.1-1 Sort Criterion)

Fig. 10.4.1-1: Sort Criterion

[Sort Criterion]	Display of the selected sort criterion:
(Chronological)	represents the chronological sequence in which the measuring results were obtained
(Sample ID + Assay)	represents the sequence of results sorted according to the first criterion the sample identification number (ascending or descending numerical sequence) and then according the assay (alphabetical).
(Assay + Sample ID)	represents the sequence of results sorted according to assay (alphabetical) and then according sample identification number (ascending or descending numerical sequence).
(Sender)	represents the sequence of measuring results sorted according to sender (not available in Calibrator)
(Patient Name)	represents the sequence of measuring results sorted according to patient names (alphabetical) (not available in Calibrator)
[Filter]	A filter can be applied over all measuring results and by this means all results, e.g.

with a special sample number, can be selected with a special assay. Enter a filter for this purpose in the entry field. The filter options are then activated and can be selected.

[Order]

It is possible to sort the results in “**Ascending**” or “**Descending**” order.

[Date]

represents the sort criterion time from begin to the end.

10.4.2 [Calibrator] icon <Online> in detail

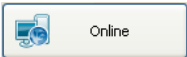
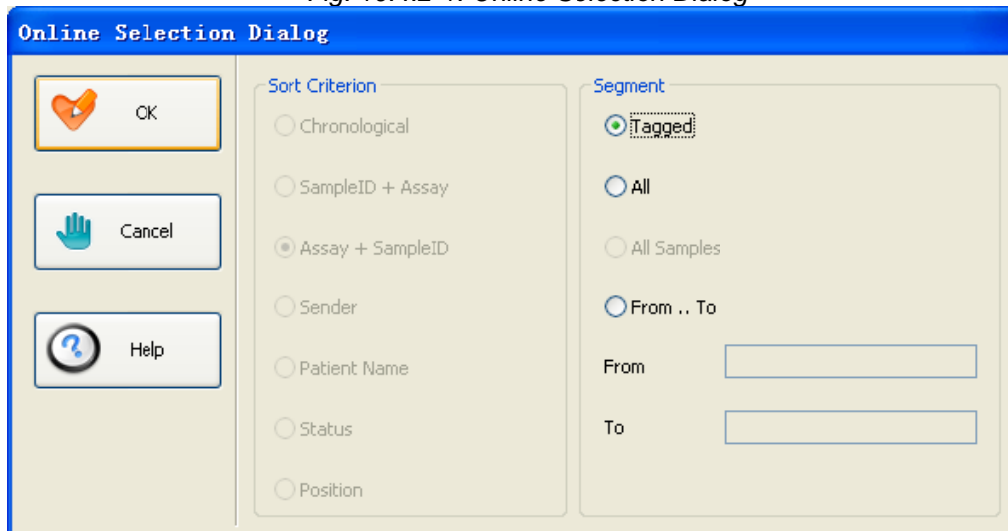
Press the icon  in the **[Calibrator]** interface to open the **[Online Selection Dialog]**. (See Fig.10.4.2-1: *Online Selection Dialog*.)

Fig. 10.4.2-1: *Online Selection Dialog*



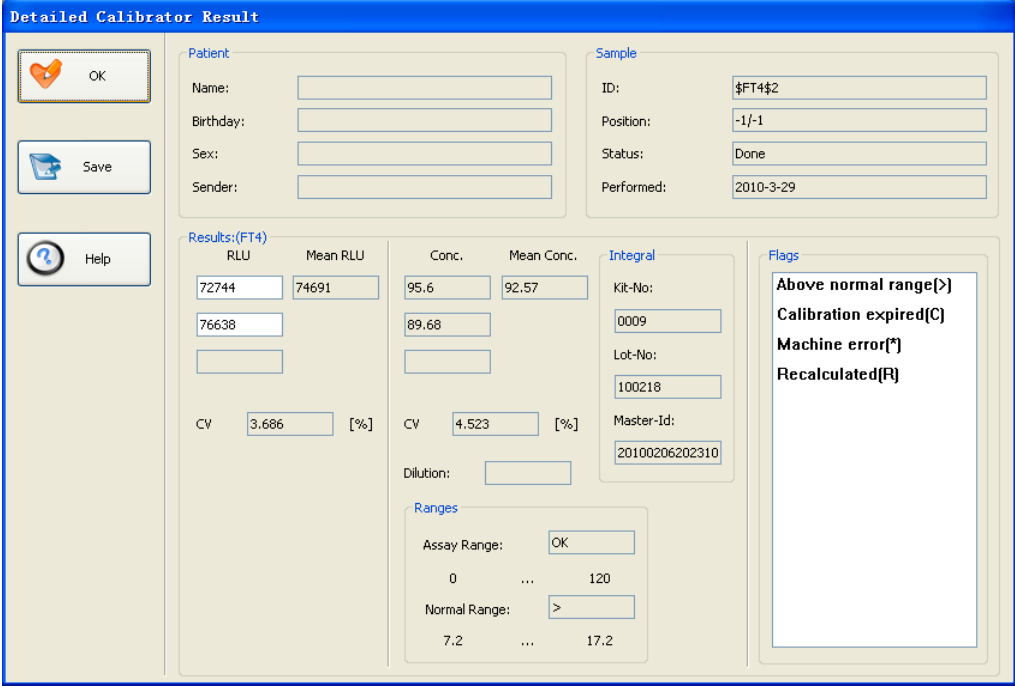
In this dialog only the **[Segment]** area is available for the user and indicates which measuring results should be transferred to the host computer.

Confirming the selection with  starts the upload.

10.4.3 [Calibrator] icon <View> in detail

Press the icon  in the **[Calibrator]** to open the **[Detailed Calibrator Result]** dialog. (see Fig.10.4.3-1: Detailed Calibrator Result)

Fig. 10.4.3: Detailed Calibrator Result



Detailed Calibrator Result

Patient

Name:

Birthday:

Sex:

Sender:

Sample

ID:

Position:

Status:

Performed:

Results:(FT4)

RLU	Mean RLU	Conc.	Mean Conc.
<input type="text" value="72744"/>	<input type="text" value="74691"/>	<input type="text" value="95.6"/>	<input type="text" value="92.57"/>
<input type="text" value="76638"/>		<input type="text" value="89.68"/>	
<input type="text"/>		<input type="text"/>	

CV [%]

CV [%]

Dilution:

Integral

Kit-No:

Lot-No:

Master-Id:

Flags

Above normal range(>)
 Calibration expired(C)
 Machine error(*)
 Recalculated(R)

Assay Range:

0 ... 120

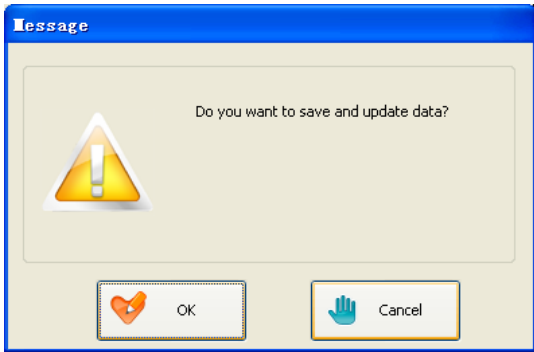
Normal Range:

7.2 ... 17.2

This dialog displays:

- [Results]** Displays the RLU and the flags Mechanics, Inc Temp, Low/No Serum/Reagent
- [Mean RLU]** Displays the mean RLU
- [CV %]** Displays the CV in percent

It allows editing RLU results and press <OK> in the pop up dialog to save the results. Otherwise press <Cancel> to leave without saving.



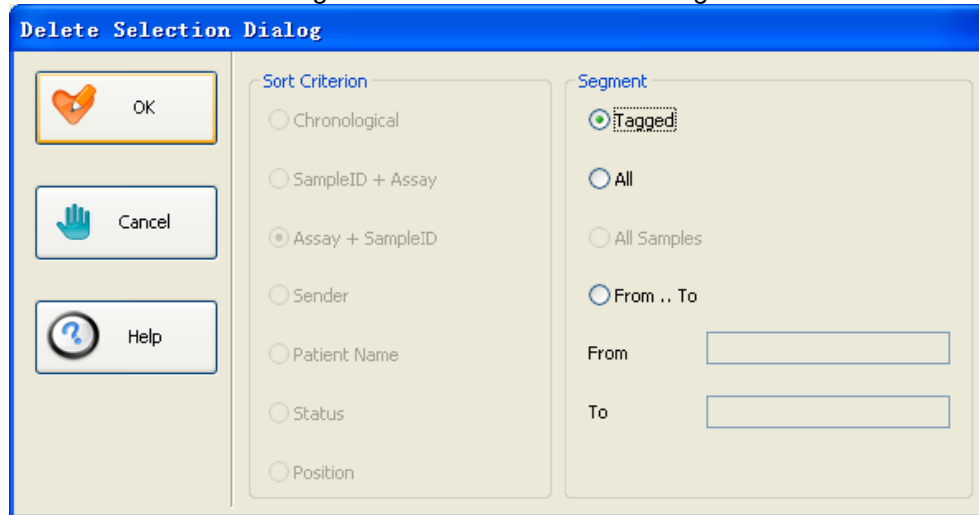
Message

Do you want to save and update data?

10.4.4 [Calibrator] icon <Delete> in detail

Press the icon  in the **[Calibrator]** dialog to open the **[Delete Selection Dialog]**. (See Fig.10.4.4: Delete Selection Dialog)

Fig. 10.4.4: Delete Selection Dialog



In this dialog only the **[Segment]** area is available for the user and indicates which measuring results should be deleted.

10.4.5 [Calibrator] icon <Print> in detail

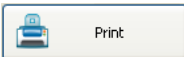
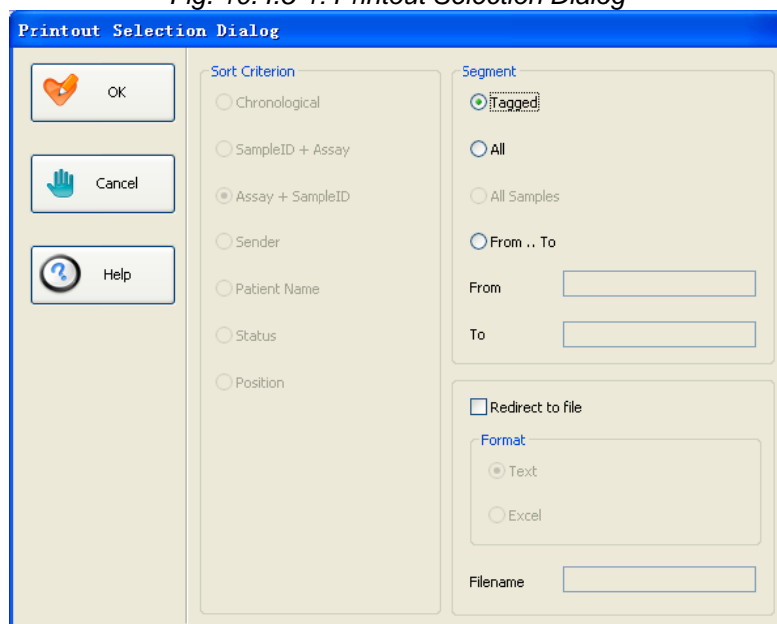
Press the icon  will open the **[Printout Selection Dialog]**. (See Fig. 10.4.5-1: Printout Selection Dialog)

Fig. 10.4.5-1: Printout Selection Dialog



[Sort Criterion]

Display of the sort criterion selected for printout as described in <Sort> (section 10.4.1).

[Segment]

Indication of the segment to be printed.

(Tagged) The segment to be printed consists of tagged results. For tagging a result (a line) press the key <F7>. Pressing <F7> again cancels the tagging. Tagged results are indicated on the end of the line with “ * ”

(All) All results

What is all results? The different behaviors must be described.

(From...To) Range indication. On selecting this option, the entry fields are activated for entry of the beginning and end of the range to be printed.

[Redirect to file]

Saving the measuring results as a file on a data storage device. (i.e. floppy disk, USB flash stick)

(Format) can be <Text>, <Excel>

10.5 [Control] icon in detail


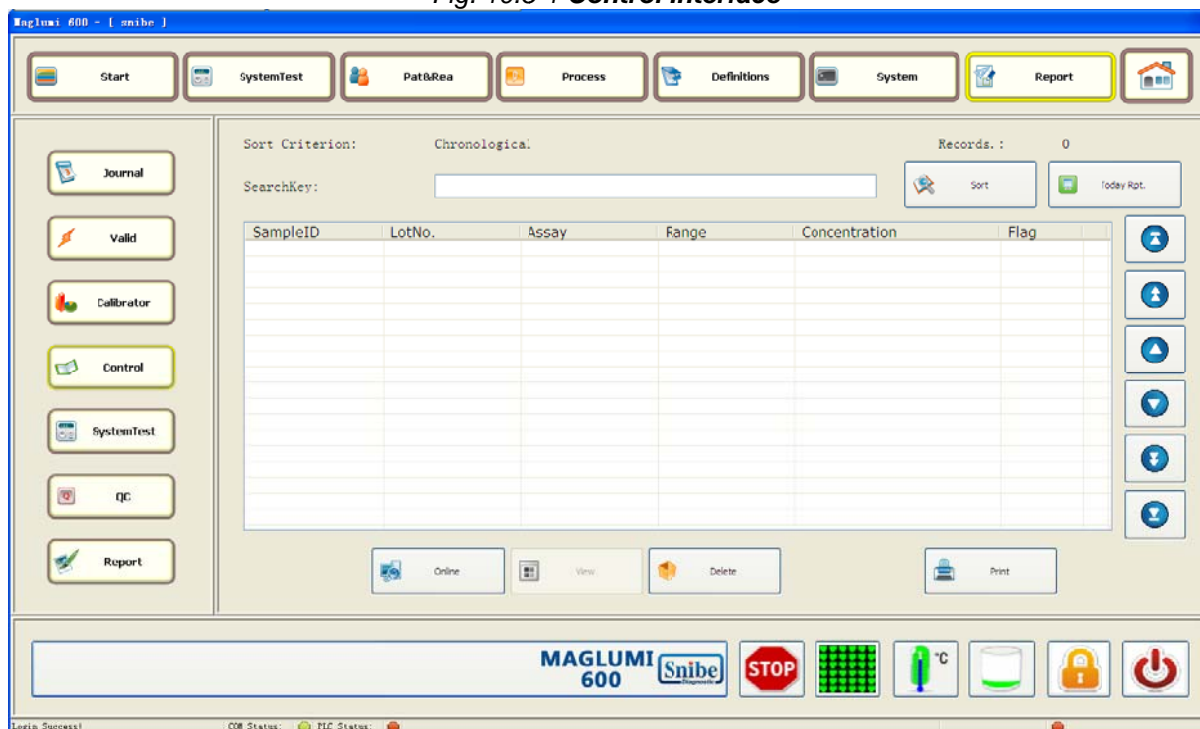






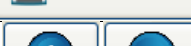


Select <Report> in the main menu and then press  to open the [Control] interface. (See Fig.10.5-1)

Fig. 10.5-1 Control interface



<SearchKey>	Entry field for a self-selected search key e.g. assay. All measuring results of this assay are then placed at the beginning of the list of measuring results	
 Sort	Display of the selected sort criterion.	10.5.1 [Control] icon <Sort> in detail
 Today Rpt.	Display all the control results done today	
 Online	Opens the [Online Selection Dialog] which allows choosing the results to be sent online to the host computer.	10.5.2 [Control] icon <Online> in detail
 View	Opens the Detailed Sample Result dialog-validated- and allows viewing the detailed information about the validated results.	10.5.3 [Control] icon <View> in detail
 Delete	Opens the Selection Dialog, which allows choosing the results to be deleted.	10.5.4 [Control] icon <Delete> in detail
 Print	Opens the Printout Selection Dialog which allows choosing the results to be printed out	10.5.5 [Control] icon <Print>In detail
	To view the results one by one	
	To view the results page by page	
	To go to first & last page	

10.5.1 [Control] icon <Sort> in detail

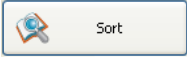
Press the icon  in the < **Control** > interface to open the dialog **[Sort Criterion]**. (See Fig. 10.5.1-1 Sort Criterion)

Fig. 10.5.1-1: Sort Criterion

[Sort Criterion]

Display of the selected sort criterion:

(Chronological)

represents the chronological sequence in which the measuring results were obtained

(Sample ID + Assay)

represents the sequence of results sorted according to the first criterion the sample identification number (ascending or descending numerical sequence) and then according the assay (alphabetical).

(Assay + Sample ID)

represents the sequence of results sorted according to assay (alphabetical) and then according sample identification number (ascending or descending numerical sequence).

(Sender)

represents the sequence of measuring results sorted according to sender (not available in Control)

(Patient Name)

represents the sequence of measuring results sorted according to patient names (alphabetical) (not available in Control)

[Filter]

A filter can be applied over all measuring results and by this means all results, e.g. with a special sample number, can be selected with a special assay. Enter a filter for this purpose in the entry field. The filter options are then

activated and can be selected.

[Order]

It is possible to sort the results in “**Ascending**” or “**Descending**” order.

[Date]

represents the sort criterion time from begin to the end.

10.5.2 [Control] icon <Online> in detail


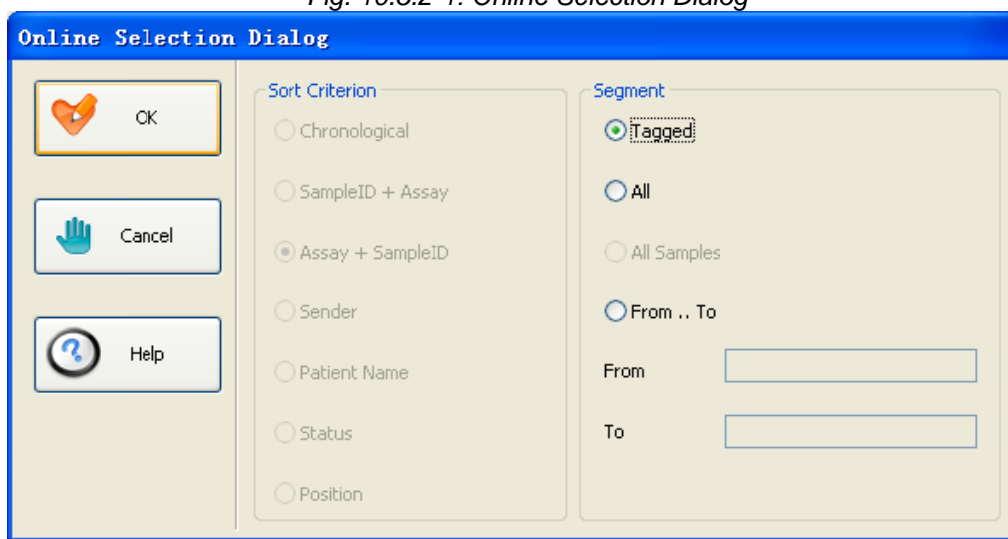

Press the icon  in the **[Control]** interface to open the **[Online Selection Dialog]**. (See Fig.10.5.2-1.)

Fig. 10.5.2-1: Online Selection Dialog



In this dialog only the **[Segment]** area is available for the user and indicates which measuring results should be transferred to the host computer.

Confirming the selection with  starts the upload.

10.5.3 [Control] icon <View> in detail


Press the icon  in the **[Control]** interface to open the [Detailed Control Result] dialog. (see Fig.10.5.3-1)

Fig. 10.5.3-1: Detailed Control Result

This dialog displays:

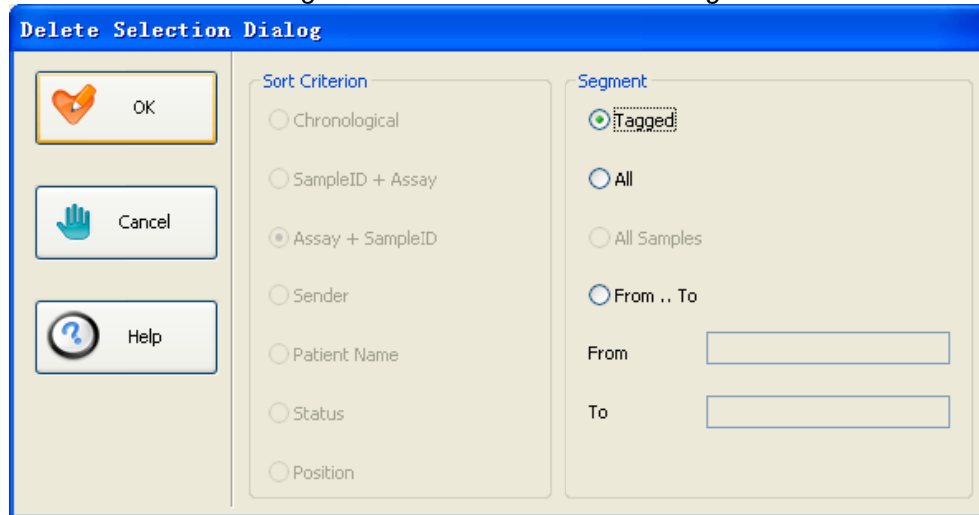
- [Results]** Displays the RLU and the flags Mechanics, Inc Temp, Low/No Serum/Reagent
- [Mean RLU]** Displays the mean RLU
- [CV %]** Displays the CV in percent

It allows editing RLU results and press <OK> in the pop up dialog to save the results. Otherwise press <Cancel> to leave without saving.

10.5.4 [Control] icon <Delete> in detail

Press the icon  in the **[Control]** interface to open the **[Delete Selection Dialog]**. (See Fig.10.5.4-1)

Fig. 10.5.4-1: Delete Selection Dialog



In this dialog only the **[Segment]** area is available for the user and indicates which measuring results should be deleted.

10.5.5 [Control] icon <Print> in detail


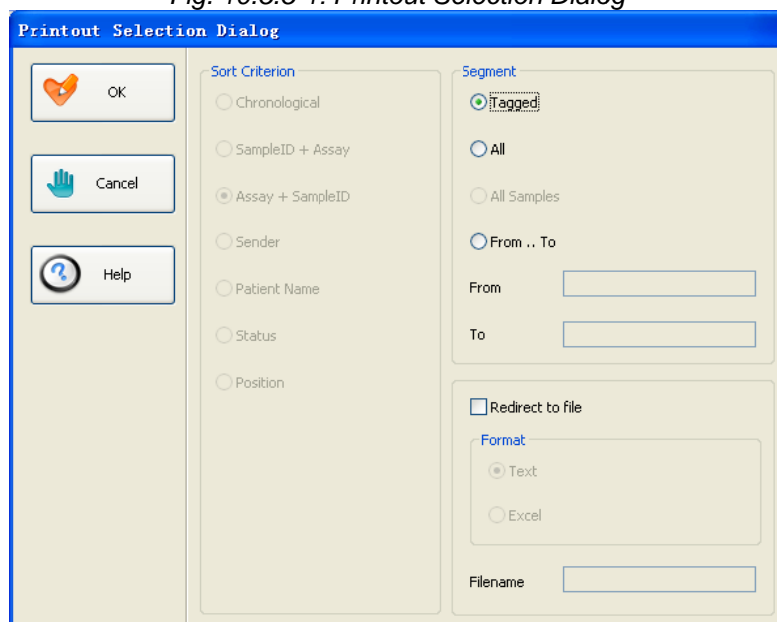
Press the icon  will open the **[Printout Selection Dialog]**. (See Fig. 10.5.5-1)

Fig. 10.5.5-1: Printout Selection Dialog



[Sort Criterion]

Display of the sort criterion selected for printout as described in <Sort> (section 10.5.1).

[Segment]

Indication of the segment to be printed.

(Tagged) The segment to be printed consists of tagged results. For tagging a result (a line) press the key <F7>. Pressing <F7> again cancels the tagging. Tagged results are indicated on the end of the line with “ * ”

(All) All results

What is all results? The different behaviors must be described.

(From...To) Range indication. On selecting this option, the entry fields are activated for entry of the beginning and end of the range to be printed.

[Redirect to file]

Saving the measuring results as a file on a data storage device. (i.e. floppy disk, USB flash stick)

(Format) can be <Text>, <Excel>

10.6 [System Test] icon in detail

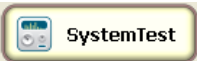
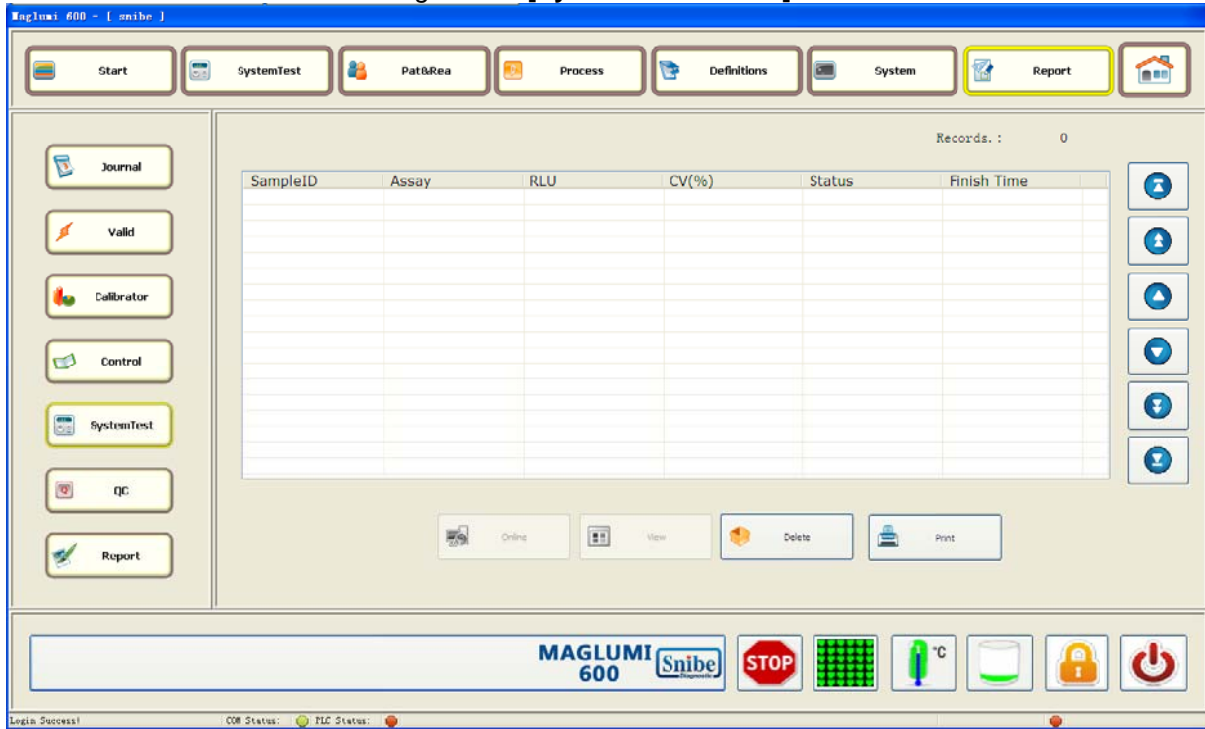
Select <Report> in the main menu and then press  to open [System Test] interface. (See Fig. 10.6-1: System Test)

Fig. 10.6-1 [System Test Result]












 Print	Opens the Printout Selection Dialog, which allows choosing the results to be printed out	
 View	Opens the [Detailed System Test Result dialog] and allows viewing/editing the detailed information about the tested results.	
 Delete	Opens the Selection Dialog, which allows choosing the results to be deleted.	
 	To view the results one by one	
 	To view the results page by page	
 	To go to first & last page	

Fig.10.6-2 [Detail System Test Result] dialog box

The dialog displays:

[Info]

Shows Sample ID, status and the time of result.

[Method]

Shows the type of assay.

[Results]

(RLU) Displays RLU values for assay (6 values related to 6 replicates)

(Mean) Displays the mean RLU

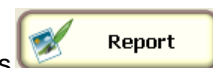
(CV %) Displays the CV in percent

10.7 [QC] icon in detail



The icon function is not implemented.

10.8 [Report] icon in detail



Select **<Report>** in the main menu and then press **Report** to open **[Report]** interface. (See Fig. 10.8-1: Report)

Fig.10.8-1 [Report] interface

The dialog displays:

[Save]

To save the patient information.

[Add]

To manually add new a patient.

[Modify]

To modify the patient information.

[Delete]

To delete a patient from the list.

[Print]

To print the patient report. For tagging a result (a line) press the key <F7> for selection. Pressing <F7> again cancels the tagging. Or check the for bunch printing.

The printed results are indicated on the end of the line with " **red flag**".

Chapter 11

Menu [Patients & Reagents] -Patient Section in detail

11.1 [Patients] section in overview	2
11.2 [Sample Loading] dialog in detail	3
11.2.1 [Rack Station] in detail	4
11.2.2 [Sample- ID] in detail.....	5
11.2.3 [Assay Group/ Assay List].....	7
11.2.3.1 How to assign a single assay to a single patient sample.....	8
11.2.3.2 How to assign a single assay to all displayed patient samples “Copy function”	8
11.2.4 [Loading] in detail.....	9
11.2.4.1 [Loading] icon <Entire>, & <Edit> in detail	10
11.2.4.2 [Loading] icon <STAT> in detail	11
11.2.4.3 [Loading] icon <Control> in detail	12
11.2.4.4 [Loading] icon <Std/LC> Double Blind Entry	14
11.2.4.5 [Loading] icon <Dilute> in detail.....	15
11.2.5 exiting and confirmation.....	17

11.1 [Patients] section in overview

Unlike the normal icons in the MAGLUMI® software, the **<Patients & Reagent>** icon is accessed by clicking on the picture that appears as a patient area and is also labeled **[Patients] section** (see fig 11.1-1).

The dialog shown is one of two dialogs in the software that does not contain a dialog name. For this reason it has been named the **[Sample and Reagent Loading]** dialog

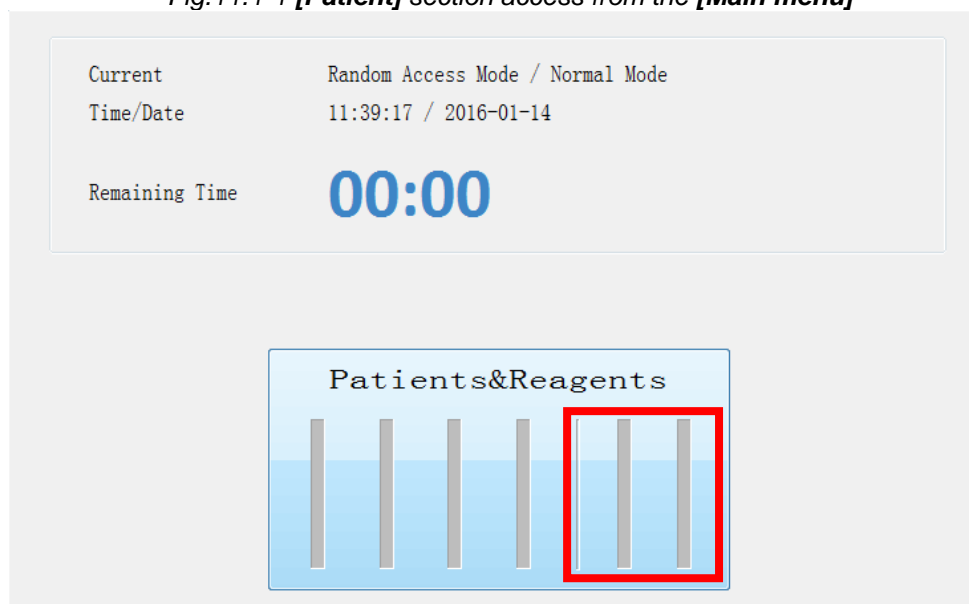
This dialog can be accessed in two ways:

- (1) Pressing the icon pictured below
- (2) Opening the patient&reagent area flap on the analyzer.

When accessing this icon, the user is able to:

- Load all sample types
- Patient samples
- Controls
- External calibrators
- Light check
- Assign tests to patient samples
- Assign defined dilutions to sample tests
- Load and assign a STAT test
- Verify tests and dilutions assigned to samples

Fig. 11.1-1 **[Patient]** section access from the **[Main menu]**



There are two colors of the sample racks that can be viewed from the **[Main Menu]** (see fig 11.1-1).

- | | |
|-------|--|
| RED | A sample rack that has not been recognized by the system
[ERROR] |
| GREEN | A sample rack that has been recognized by the system. |

11.2 [Sample Loading] dialog in detail

Clicking on the <Patient> icon or opening the flap of the Patient area on the analyzer opens the [Sample Loading] dialog.

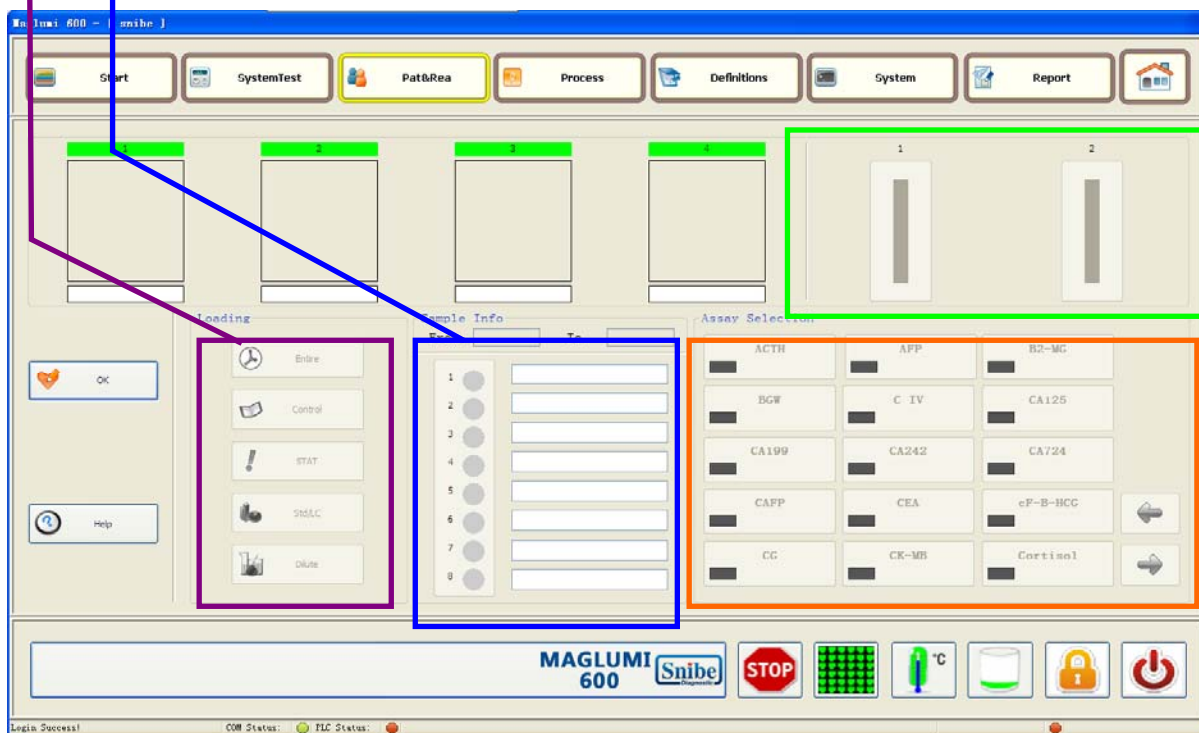
This dialog consists of six areas and is divided into sections that are explained below by the color-coordinated boxes and visualized in fig.

This section is [Loading] for additional settings of an individual patient or test. See 11.2.4.

This section is labeled [Sample- ID] for detailed sample identification. See 11.2.2.

This section is labeled [Rack Station] and is used for visual verification of rack positions. See 11.2.1.

Fig.11.2-1: [Sample Loading] dialog



This section is [Assay Group] / [Assay List] used for selecting tests for patient samples. See 11.2.3.

11.2.1 [Rack Station] in detail

The section **[Rack Station]** is designed to inform the user of the physical status of the sample racks currently present in the patient area of the analyzer and to allow the user to select the placed racks (only single selection available).

The section displays lanes 1-8, each representing a rack in the Rack Station.

There are four types of display variations for each rack position in the **[Rack Station]** section as defined in the table 11.2.1-1 Rack Symbol definition and also pictured in fig 11.2.1-1: **[Sample Loading]** dialog - **[Rack Station]**.

Table 11.2.1-1 Rack Symbol definitions

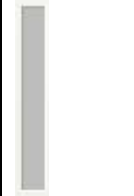
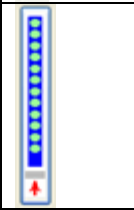
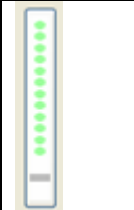

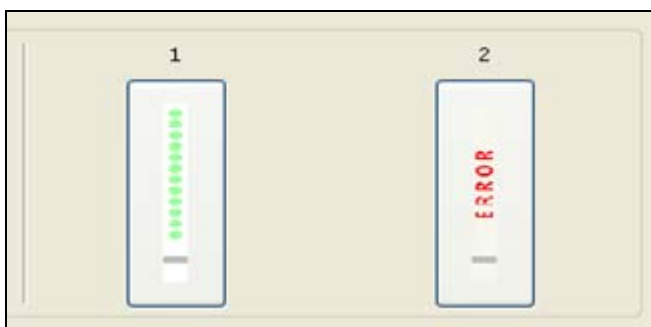
	This symbol depicts an empty position in the patient area of the analyzer (no patient/sample rack inserted).
	This symbol depicts a loaded and recognized rack in a position in the patient area of the analyzer (the red arrow means that this rack has been selected by the user and its sample entries [if present] are currently displayed in the [Sample Info] section).
	This symbol depicts a loaded and recognized rack in a position in the patient area of the analyzer (the gray color means that this rack has not been selected by the user).
	This symbol depicts a loaded and non-recognized rack in a position in the patient area of the analyzer. The [ERROR] symbol means that this rack has not been recognized by the system. This rack must be removed and reinserted.

Fig.11.2.1-2: [Sample Loading] - [Rack Station] section



11.2.2 [Sample- ID] in detail

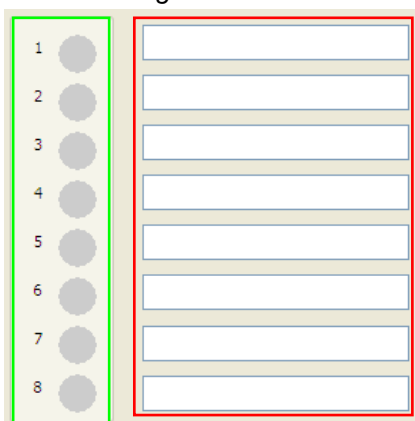
The [Sample Info] section of the [Sample Loading] dialog displays the samples of the selected rack only. In order to reduce manual errors, all manual entries require the user to enter the ID twice.

The section is divided into two sub-sections:

- Sample Position
- Sample Info

A maximum of 8 patient samples can be inserted into the patient/sample racks at one time

Fig. 11.2.2-1



[Sample Position]

Sample Position displays the numbered position of the identified samples. The positions are also filled with the color of corresponding type of test. See the Table 11.2.2-1 Sample Info color definitions.





[Sample- ID]

Sample- ID displays the sample identification name or number beside the associated sample position.

The field bordering and position arrows are the color of corresponding type of test. The field will only be colored upon entering the sample type but the arrow will always retain the proper color. See the Table 11.2.2-1 Sample Info color definitions.

If a sample is currently running/active, or a result for a sample is present in the [Daily – Lab Journal], the Sample Info field will be displayed as dark gray and non-editable.

Table 11.2.2-2 Sample Info color definitions

1		sample_01	The color blue depicts a normal patient sample.
1		\$1C-1e\$	The color yellow depicts an external calibrator or Light Check (system test).
3		#1234213#	The color green depicts a system-recognized control.
7		0406153041_12_07	The color red depicts a STAT test that has been selected for a patient.

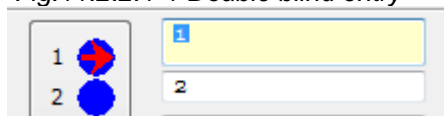
[Sample- ID] Double Blind Entry



When manual data input in the MAGLUMI Diagnostic System is needed, it is necessary, for safety reasons, to verify the data by repeating the input without displaying the previously received data. [132 135; 243; 135a]

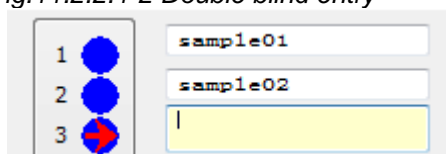
The field for the entry extends itself to the double height containing two entry fields and a dark gray colored frame.

Fig.11.2.2.1-1 Double blind entry



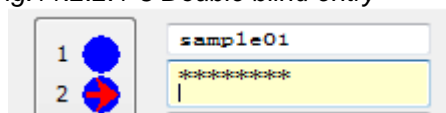
The keyboard focus is set to the upper field, enabling the user to enter the data.

Fig.11.2.2.1-2 Double blind entry



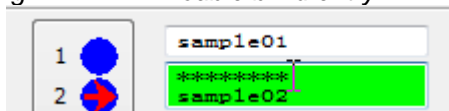
By pressing the “ENTER” or “TAB” the focus changes to the second field, altering the first input to “ * ”.

Fig.11.2.2.1-3 Double blind entry



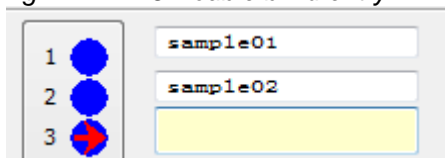
After correct retyping the input is displayed and the color of the frame changes from gray to green color of the sample (see Table 11.2.1-1 Sample Info color definitions).

Fig.11.2.2.1-4 Double blind entry



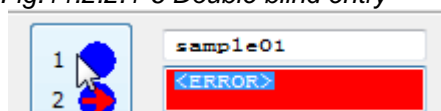
The focus changes to the next entry field.

Fig.11.2.2.1-5 Double blind entry



If the second input is not correct the field is displayed as <ERROR!>.

Fig.11.2.2.1-6 Double blind entry



Then the first and the second entry must be reentered.

11.2.3 [Assay Group/ Assay List]

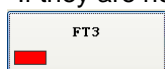
The tests that the user is able to select for each sample are displayed on the right side of the **[Sample Loading]** section.

The assay catalog is predefined in <Definitions> → **[Definition Functions]** → < Group>. (See chapter 7.4 for details).

Each page is titled for the related group that it has been assigned to.

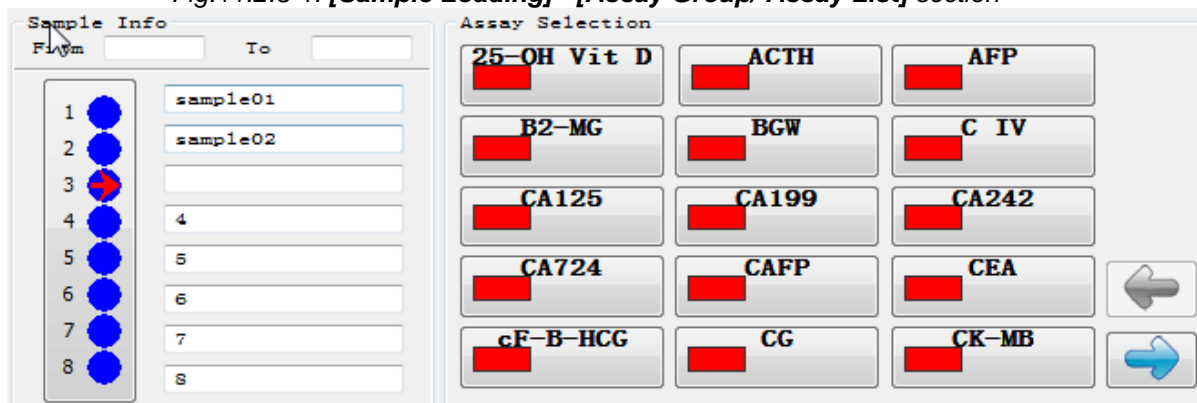
If the assays are inserted into the integral area of the analyzer (on board), they are displayed in dark gray.

If they are not “on board” they are displayed in light gray color.



To select previous or next page use the arrows

Fig.11.2.3-1: [Sample Loading] - [Assay Group/ Assay List] section



11.2.3.1 How to assign a single assay to a single patient sample

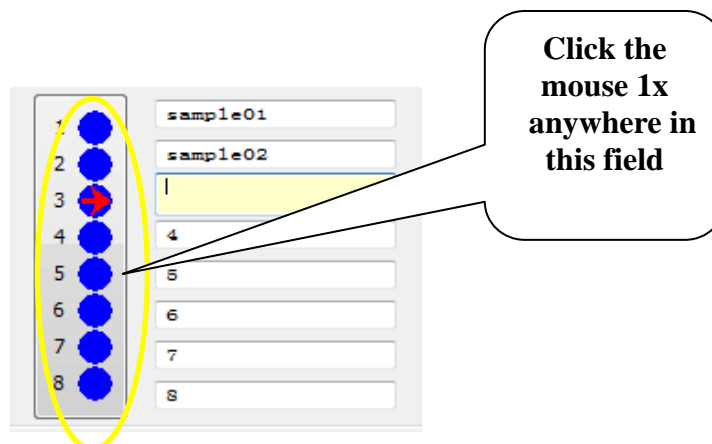
To assign one or more assays to a sample singularly.

1. Select the appropriate sample.
2. Select the assay by pressing the proper test icon for the assay(s) (the LED on the icon of the selected assay changes from red to green).

11.2.3.2 How to assign a single assay to all displayed patient samples “Copy function”

To assign one or more assays to all displayed samples simultaneously.

1. Press the Sample position area shown below.



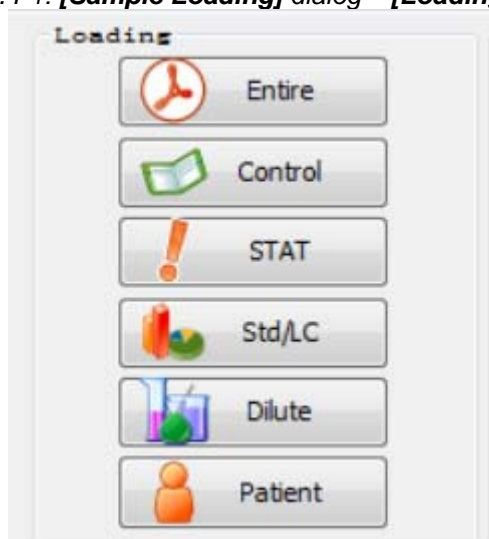
The sample position icon and patient ID's are shown in a light gray color.







2. Select the assay(s) by pressing the proper test icon for the assay(s) (the LED on the icon of the selected assay changes from red to green).
3. Release the “copy function” by pressing the sample position area again. Afterwards these selected tests will be programmed for all samples in this rack.

11.2.4 [Loading] in detail

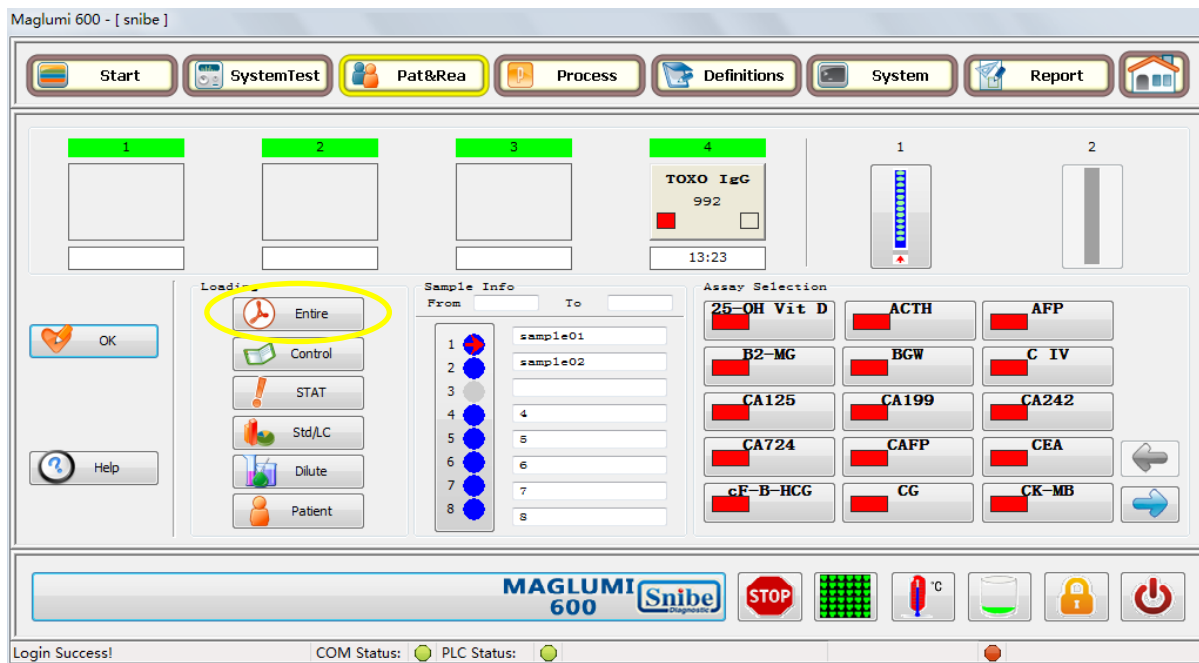
The **[Loading]** section located in the **[Sample Loading]** dialog controls the options that the user may or may not choose for a patient. Some of these options may be chosen in conjunction with one another.


Fig 11.2.4-1: **[Sample Loading]** dialog – **[Loading]** section

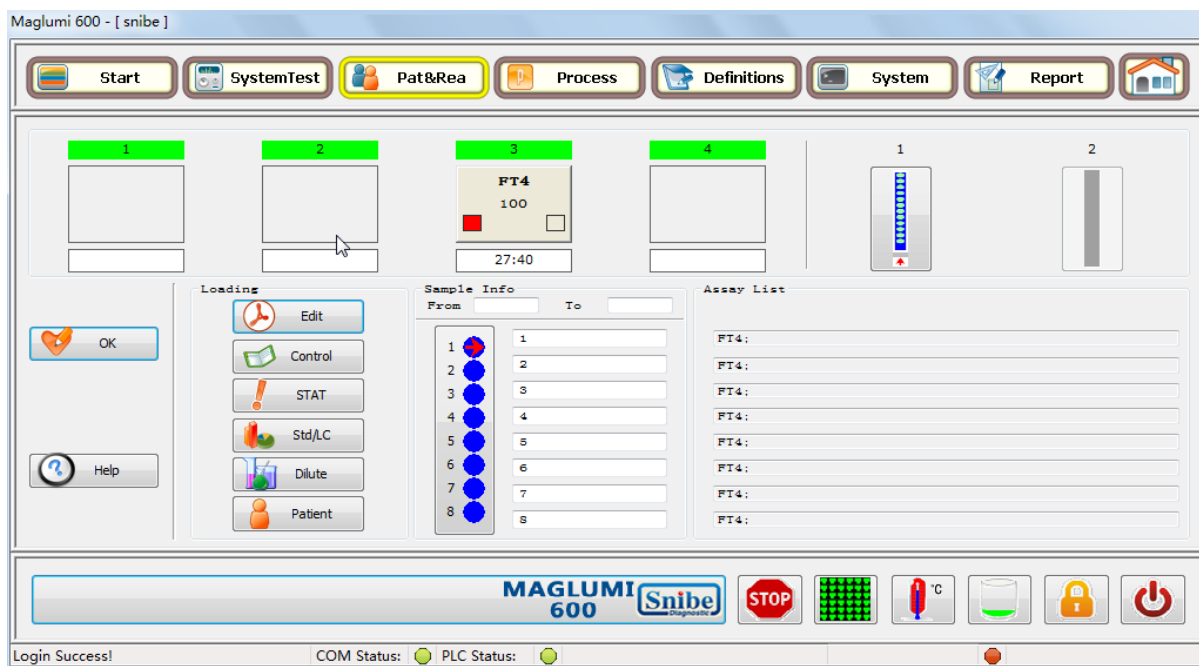


 Entire	Pressing this icon displays the Sample- ID and the Assay Group on the right side	11.2.4.1 [Loading] icon <Entire>, & <Edit> in detail
 Edit	Pressing this icon displays the Sample- ID and the Assay List on the right side	11.2.4.1 [Loading] icon <Entire>, & <Edit> in detail
 STAT	Pressing this icon defines a selected sample as STAT sample (emergency sample) The entry field is marked with a red frame.	11.2.4.2. [Loading] icon <STAT> in detail
 Control	Pressing this icon opens the [Controls selection] dialog	11.2.4.3 [Loading] icon <Control> in detail
 Std/LC	Pressing this icon changes the color of the frame to yellow and allows the use of external calibrators or Light Check	11.2.4.4 [Loading] icon <Std/LC> Double Blind Entry
 Dilute	Pressing this icon opens a dialog which allows to assign predefined dilutions for an assay to a sample	11.2.4.5 [Loading] icon <Dilute> in detail

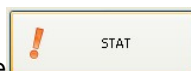
11.2.4.1 [Loading] icon <Entire>, & <Edit> in detail



Pressing the icon  changes the [Assay Group] section to [Assay List] and displays the tests that have been assigned to each patient sample. The [Profile Selection] section will also disappear as below picture.



11.2.4.2 [Loading] icon <STAT> in detail

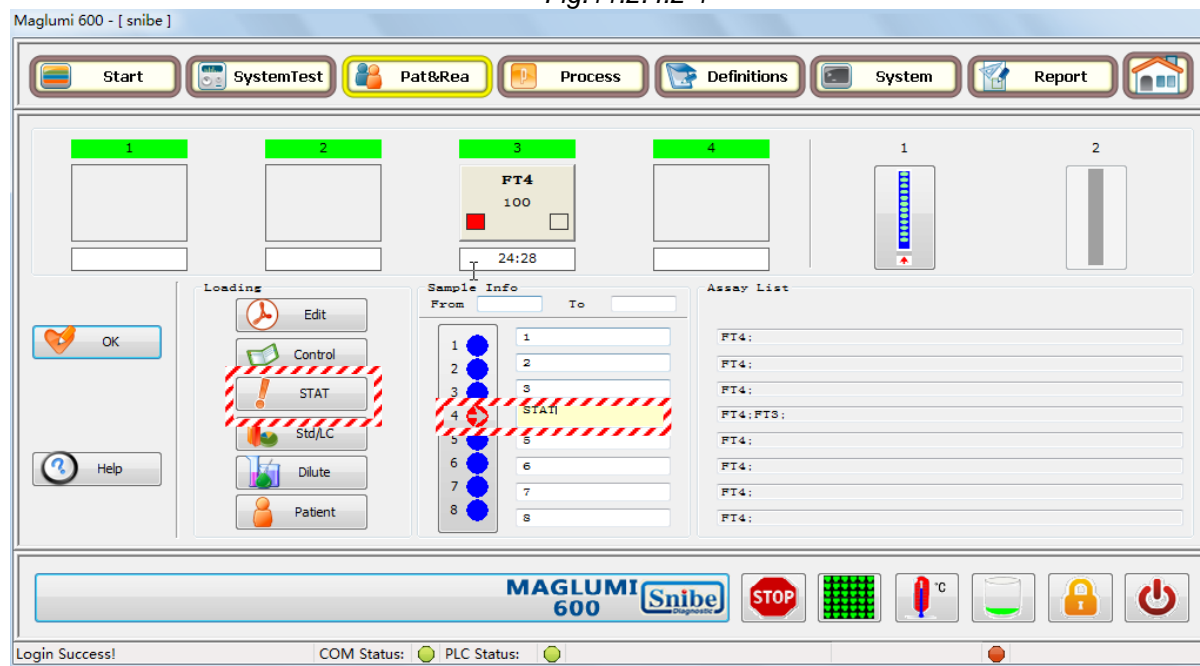


The **STAT** icon (“**S**hort **T**urn **A**round **T**ime”) is used for emergency samples (samples that require a result in a length of time relatively shorter than a normal test programmed at the same time). STAT samples have priority over normal samples with respect to test scheduling.

The length of the test will be maintained as usual. Only the scheduling will be adjusted to handle the STAT sample.

After start of the analyzer the STAT sample will be performed at the next possible pipetting point in time. All of the loaded samples that are not pipetted yet while starting the STAT sample, will be optimized using the adjusted operating mode and performed afterwards.(See Fig.11.2.4.2

Fig. 11.2.4.2-1

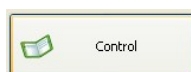
**How to:**

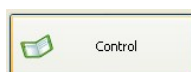
1. Select a patient sample in the **[Sample Info]** section using either the mouse or the touch screen.
2. Press the **<STAT>** icon and the LED of the selected sample will change to red.
3. Select the desired test in the **[Assay Group]** section.
4. Close the patient area flap of the analyzer or press **<OK>**.
5. Press the **<Start>** icon in the **[Main Menu]** to initiate the STAT test.

NOTE

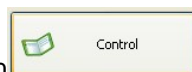
Calibrators, which are not pipetted when the STAT sample is started, will be deleted and are not displayed in the [Daily Journal] dialog. Controls, which are not pipetted when the STAT sample is started, will be placed in the "To Do" status in the daily journal

11.2.4.3 [Loading] icon <Control> in detail



The  icon allows the user to select a database-listed control. This is normally necessary when the barcode of the manufacturer controls may be damaged or a barcode is not listed.

If the system reads the presence of a control but cannot find the related data in the database, this window will appear automatically.



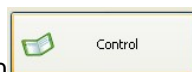
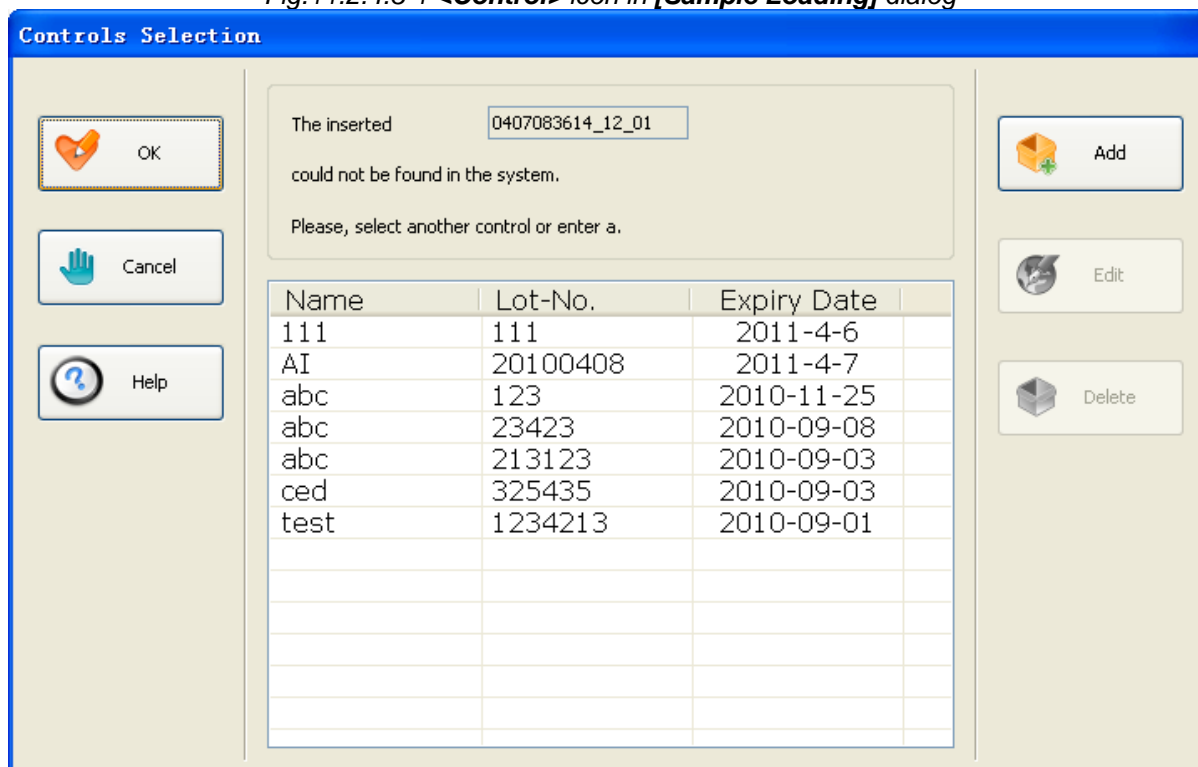
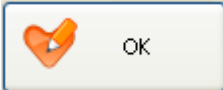



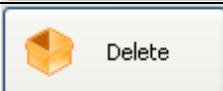
Clicking on the icon  specifies the selected sample to be a control and opens the **[Controls Selection]** dialog. (See Fig.11.2.4.3-1)

Fig.11.2.4.3-1 <Control> icon in [Sample Loading] dialog

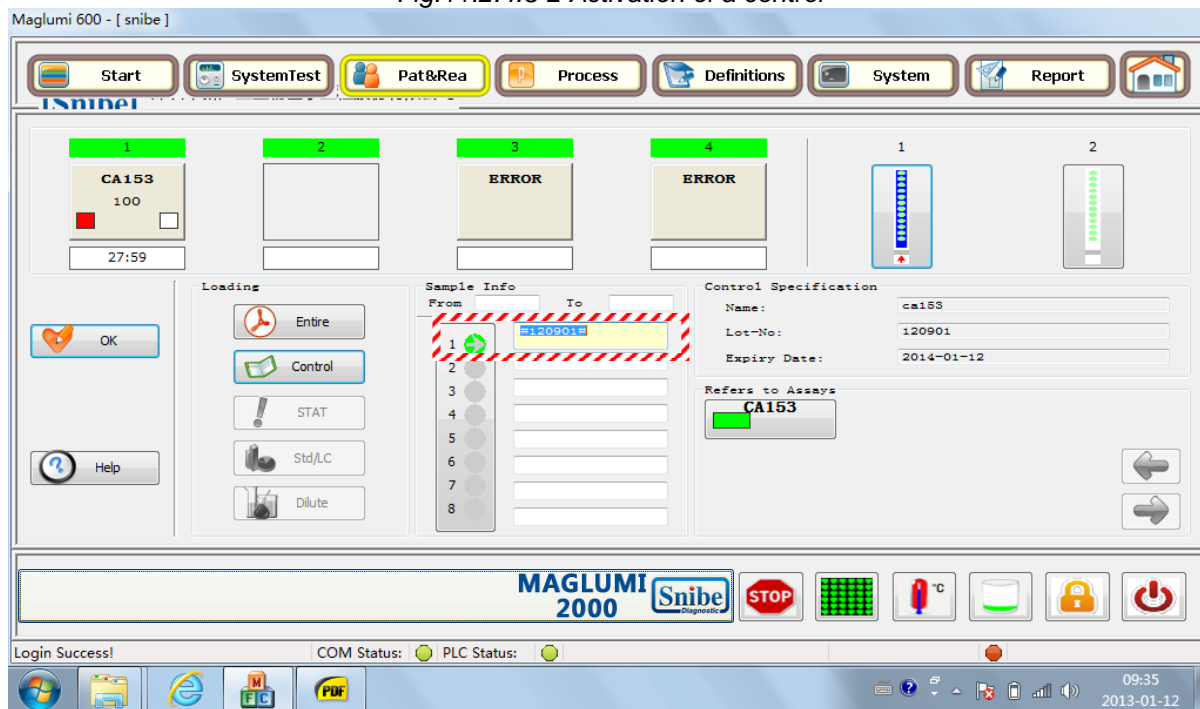


 OK	Selects the required control	11.6.4.1[Controls Selection] icon <OK>in detail
 Cancel	Discard the selection and returns to the sample loading dialog	For details see Chapter 7.3.4
 Add	Allows to define a new control if it is not predefined	For details see Chapter 7.3.4
 Edit	Allows editing a control	For details see Chapter 7.3.4
 Delete	Deletes a selected control	For details see Chapter 7.3.4

How to:

1. Select a patient sample in the **[Sample Info]** section using either the mouse or the touch screen.
2. Press the **<Control>** icon and the **[Controls Selection]** dialog will open.
3. Select the desired control and press **<OK>** to confirm.
4. After selecting the control, it will be displayed in the **[Sample Loading]** dialog as pictured below (see Fig.11.2.4.3-2). It will be necessary to set the control so that it may be run during the next starting of patient samples.

Fig.11.2.4.3-2 Activation of a control



[Control Specification]

Displays control specific data as entered in the control section (see chapter 7.3).

[Start in next run]

If the checkbox "Start in next run" is checked, the control will be performed if the Start button is pressed.

[Refers to Assays]

Displays all assays to which the control refers to

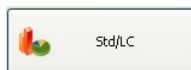
5. Select **[Start in next run]** and the **[Refers to Assays]** field will become active.

NOTE

When viewing the assigned tests in the [Assay List] section (Chapter 11.2.4.1), the controls will not be displayed. It is only possible to display a control by entering into <Results> -><Journal>.

11.2.4.4 [Loading] icon <Std/LC> Double Blind Entry




The  icon is used for manual entry of Light Check and external calibrators. In some cases it may be necessary to enter these tests manually (i.e. defective barcode, transferred serum into a test tube, etc.). Refer to chapter 9.3.1 for entering Light check manually. The instructions below describe how to manually enter external calibrators.



LC, & external calibrators must always be placed in 1 or 2 track in sample area.

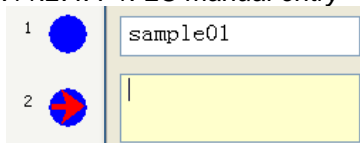


Clicking on the  button allows the user to define a selected sample field as LC (see Chapter 9).

The manual external calibration input can be achieved as follows:

1. Select the sample position in the **[Patient Loading]** section that contains the external calibrator.

Fig.11.2.4.4-1: LC manual entry




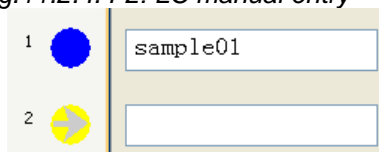
2. Press the icon  & the arrow on the sample position will turn yellow.

Fig. 11.2.4.4-2: LC manual entry



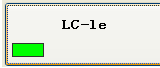
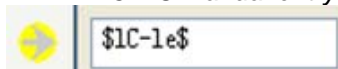
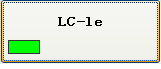
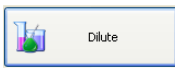
3. Select the <LC-le> icon  in the Assay selection area to assign LC for it.

Fig. 11.2.4.4-3: LC manual entry



5. After the entry has been successful, the border of the sample field will turn yellow. Then deselect the <LC-le> icon  in the Assay selection area to cancel it in the working list. Press the "TAB" or "Enter" key again and the entry will show the correct LC display and the cursor will move to the next field.

11.2.4.5 [Loading] icon <Dilute> in detail

The icon  allows the user to apply a predefined dilution to a sample. There are several requirements that must be made first.

The assay must be an assay whereas dilution is allowed.
The wanted dilution must first be created/selected in the **[Dilution Definition]** dialog (see chapter 7.7).

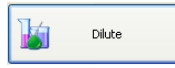
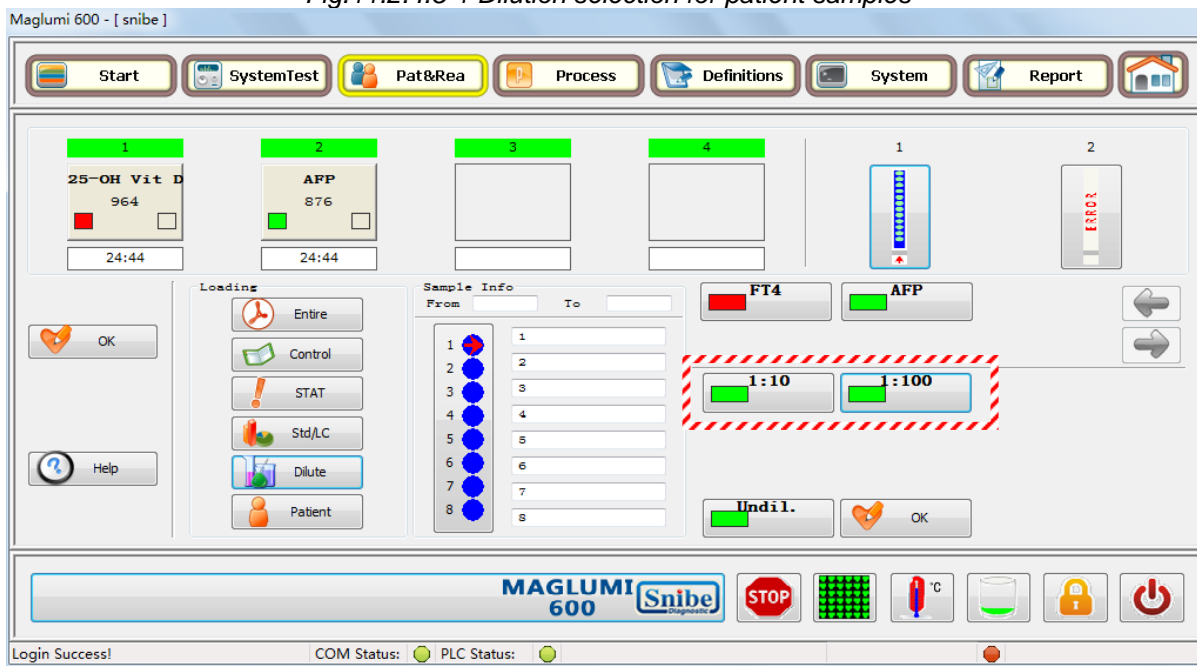
Clicking on  icon opens a dialog box with a list of assays assigned to this sample in the **[Selected Requirements]** dialog (only those assay that a dilution may be assigned to, will be listed here). After selecting an assay from this list, a list of predefined dilutions for this assay is available (see Fig. 11.2.4.5-1).

Fig.11.2.4.5-1 Dilution selection for patient samples



[Dilutions]

Predefined dilutions for this assay

[Assay]

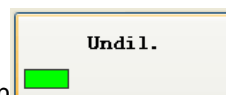
Selected assay


[Sample Info]

Selected sample

[Selected Requirements]

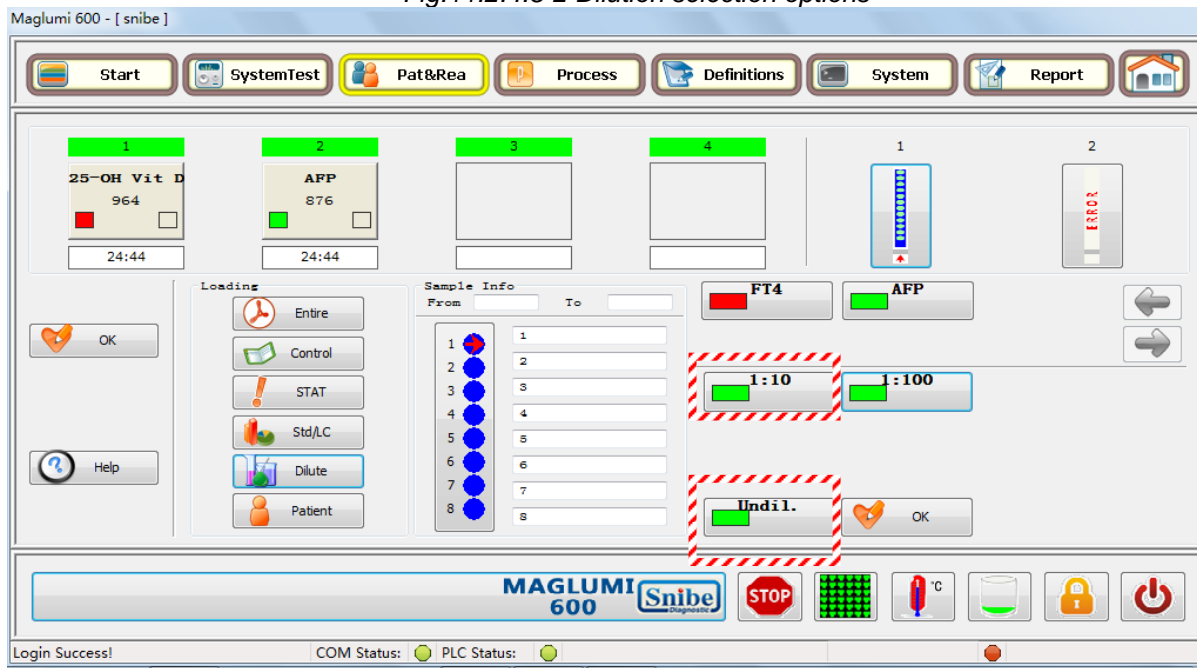
Requirements for the selected sample



As long as no dilution is selected the icon  is disabled.

If a dilution is selected the icon becomes enabled and can be deselected (see Fig.11.2.4.5-2).

Fig. 11.2.4.5-2 Dilution selection options

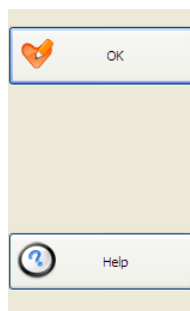


If only the diluted sample is to be tested, then the user must deactivate the **<Undil.>** icon.

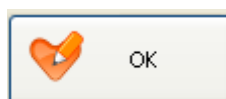
11.2.5 exiting and confirmation

The non-sectioned portion of the **[Sample Loading]** dialog is for the user to exit and confirm the dialog with the **<OK>** icon. (See fig.: 11.2.6-1 exiting, confirmation). The **<Help>** icon is not implemented.

Fig.: 11.2.6-1: exiting, & confirmation



[Sample Loading] section, **<OK>** icon



Pressing the icon from the **[Sample Loading]** dialog exits the dialog and returns to the **[Main Menu]** dialog provided the patient flap on the analyzer is closed. This icon serves only as an exit button.

Chapter 12

Menu [Patients & Reagents] -Reagent section in detail

12.1 [Reagents]section in overview.....	2
12.2 [Reagent Loading] section in detail	3
12.2.1 [Reagent Integral Area] section in detail.....	4
12.2.1.1 [Reagent Integral Area] numbered integral position color definition.....	4
12.2.1.2 [Reagent Integral Area] integral symbol definitions.....	5
12.2.1.3 [Reagent Integral Area] integral calibration status definitions	6
12.2.1.4 [Reagent Integral Area] integral time counter status definitions	7
12.2.2 [Reagent Integral Data] section in detail.....	8
12.2.2.1 [Tolerances %] section in detail	9
12.2.2.2 [Calibrators] section in detail	9
12.2.2.3 [Remaining Test] Double Blind Entry.....	10
12.2.3 [Calibration] section in detail	11
12.2.3.1 [Calibration] icon <Start> in detail.....	12
12.2.3.2 [Calibration] icon <View> in detail.....	12
12.2.4 Exiting, Confirmation, & Information.....	19

12.1 [Reagents]section in overview

Unlike the normal icons in the MAGLUMI[®] software, the **<Patients & Reagents>** icon is accessed by clicking on the picture that appears as a reagent area (see fig 12.1-1).

The dialog shown is one of two dialogs in the software that does not contain a dialog name. For this reason it has been named the **[Reagent Loading]** section.

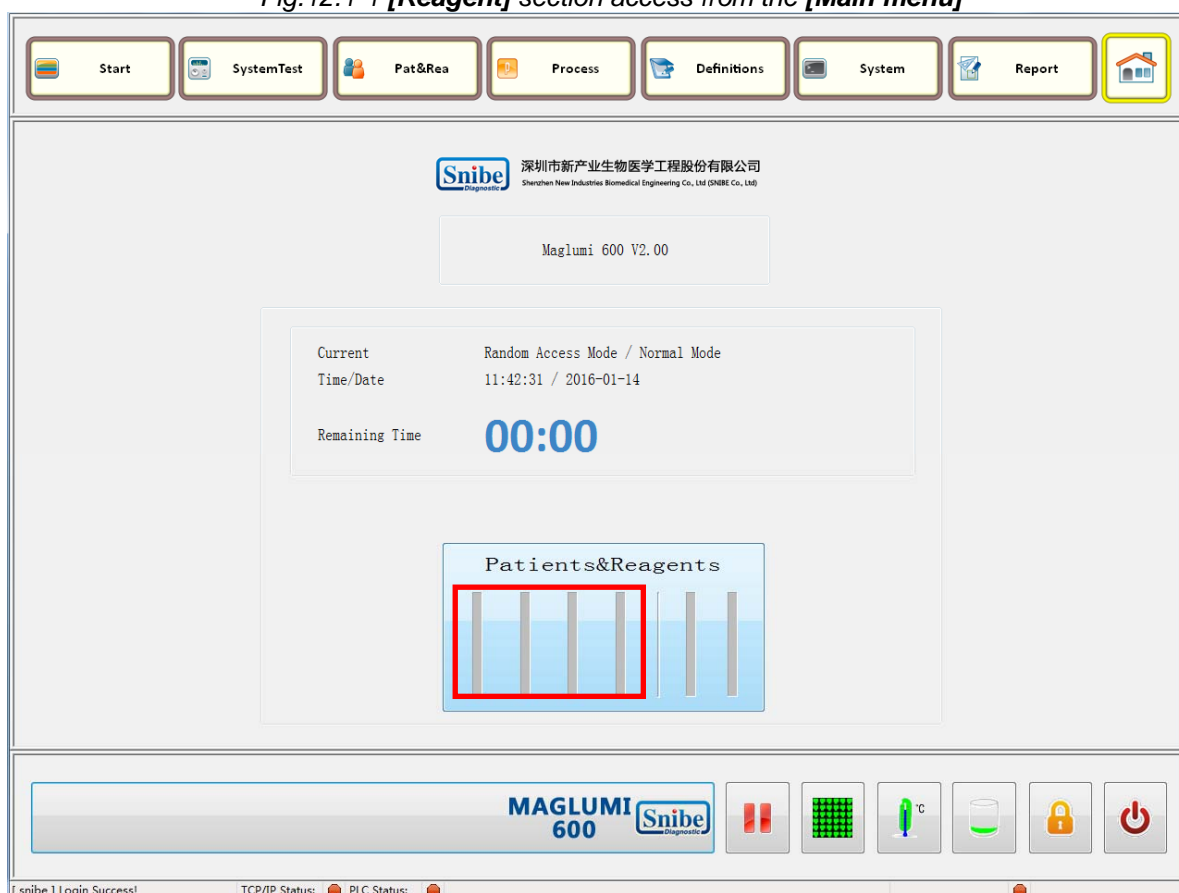
This dialog can be accessed in two ways:

- (1) Pressing the icon pictured below
- (2) Opening the reagent area flap on the analyzer.

When accessing this icon, the user is able to:

- Load/unload assay integrals
- Start/Validate/reject/check calibrations

Fig. 12.1-1 [Reagent] section access from the [Main menu]



There are three colors of the integrals that can be viewed from the **[Main Menu]** (see fig 12.1-1).

- | | |
|--------|---|
| RED | An integral that has not been recognized by the system
[ERROR] |
| Yellow | An integral that has been recognized by the system but does not have a validated calibration (i.e. calibration not present or calibration not validated). |
| Green | An integral that has been recognized by the system and |

- Purple has a validated calibration. This Reagent Integral has been correctly recognized on insertion and has a expired calibration.
- Black This Reagent Integral has been correctly recognized on insertion and has a expired kit integral.

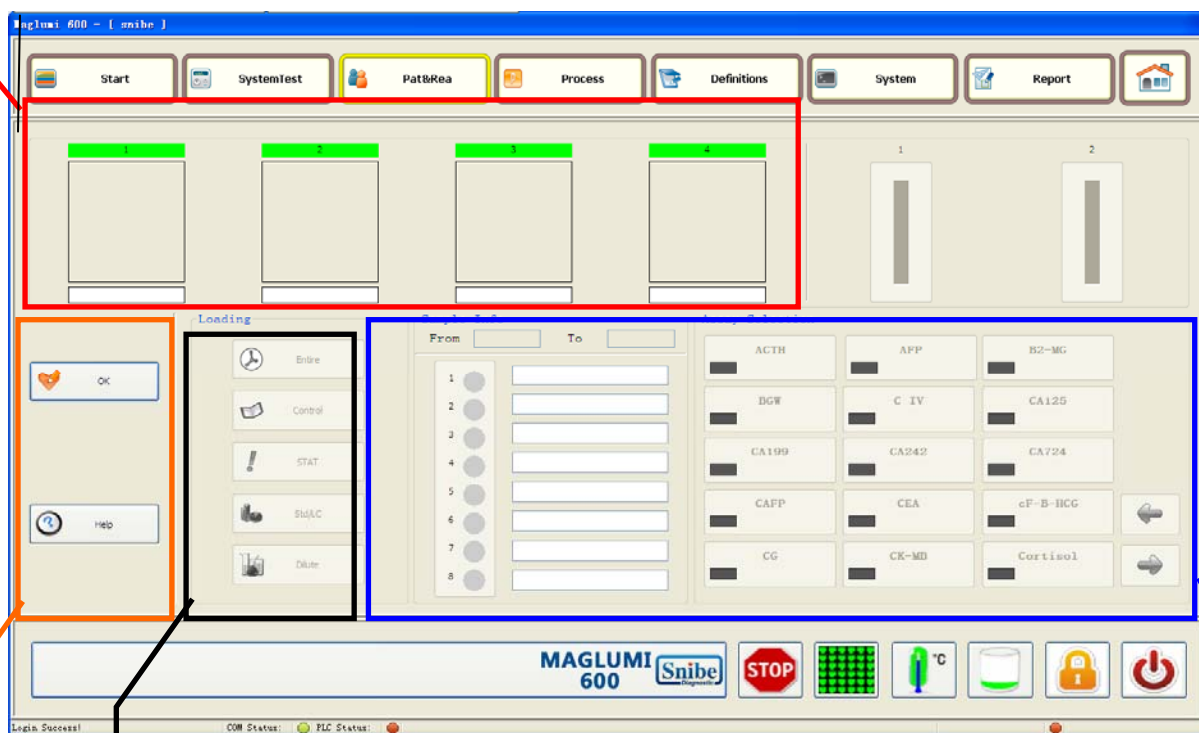
12.2 [Reagent Loading] section in detail

Clicking on the <Patients & Reagents> icon or opening the flap of the reagent area on the analyzer opens the **[Reagent Loading]** section.

This dialog consists of four areas and is divided into sections that are explained below by the color-coordinated boxes and visualized in fig.12.2-1 [Reagent Loading] section

This section is labeled [Reagent Integral Area] and is used for visual verification of integral positions. See fig.12.2.1.

Fig.12.2-1 [Reagent Loading] dialog



This section is labeled [Reagent Integral Data] for detailed integral identification. See fig 12.2.2.

This section is used for [Calibration] to validate/reject calibrated working curves. See 12.2.3.

This section is **exiting, confirmation, and information**. See 12.2.4.

12.2.1 [Reagent Integral Area] section in detail

The section [Reagent Integral Area] consists of a series of places that are either empty or filled by a button representing a reagent integral in the corresponding track on the analyzer (see Fig. 12.2.1)

Fig. 12.2.1-1 [Reagent Loading] dialog



12.2.1.1 [Reagent Integral Area] numbered integral position color definition

The numeration of the 15 Tracks for the reagent integrals (signified by a green background in fig. 12.2.1-1) indicates the pipetting status of the reagent integrals. These are defined in the examples below.





Table 12.2.1.1-1 Integral position color definitions

	<p>7 : GREEN = The integral can be removed from the reagent station. The pipetting was not started yet or is already finished.</p>
	<p>6 : RED = The integral must not be removed from the reagent station, the pipetting process is not finished</p>

12.2.1.2 [Reagent Integral Area] integral symbol definitions

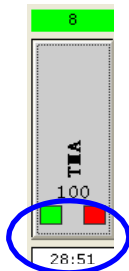
There are four types of display variations for each track position in the **[Reagent Loading]** section as defined in the table 12.2.2-1 Integral Symbol definitions and also pictured in fig 12.2.1-1: **[Reagent Loading]** section - **[Reagent Integral Area]**.

Table 12.2.1.1-2 Integral Symbol definitions

	<p>This symbol depicts an empty position in the reagent area of the analyzer (no integral inserted).</p>
	<p>This symbol depicts a loaded and recognized integral in a position in the reagent area of the analyzer (the light gray color means that this integral has not been selected by the user). After the successful insertion of the integral, the assay abbreviation is displayed on the integral button.</p>
	<p>This symbol depicts a loaded and recognized integral in a position in the reagent area of the analyzer (the dark gray color means that this integral has been selected by the user and its specific details are currently displayed in the [Reagent Integral Data] section). After the successful insertion of the integral, the assay abbreviation is displayed on the integral button.</p>
	<p>This symbol depicts a loaded and non-recognized integral in a position in the reagent area of the analyzer. The [ERROR] symbol means that this integral has not been recognized by the system. This integral must be removed and reinserted.</p>


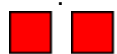




12.2.1.3 [Reagent Integral Area] integral calibration status definitions

On each integral depicted in the [Reagent Integral Area] section are two small boxes (located on the bottom of each pictured integral).



These two symbols represent the status of the calibration for that particular integral. Below is a table to help the user realize the definitions of these symbols.

Table 12.2.1.3-1 Calibration Status definition

	Symbol Combination	Definition
1.		No calibration is present and no calibration has been started
2.		No calibration is present but a calibration has been started
3.		A calibration has been completed but has not been validated
4.		A calibration has been completed and validated. No new calibration has been started.
5.		A valid calibration is present and a new calibration has been started
6.		A valid calibration is present and a new calibration has been completed but not yet validated.

12.2.1.4 [Reagent Integral Area] integral time counter status definitions

The **[Reagent Integral Area]** section contains a counter for each integral located at the bottom of the integral symbol. The purpose of this counter is to monitor the time of magnetic particle agitation

The box under the integral button displays the remaining time until the initial MP agitation time is completed.

Agitation time begins on insertion of the integral when the barcode is read (see fig. 12.2.1-1 **[Reagent Loading]** section).

Time Counter reset

The magnetic particle agitation time counter is reset under the following conditions:

Agitation time counter is reset upon initialization of the analyzer even if an integral has not been removed between initializations.

Agitation time counter is reset 2 minutes after removal of the integral (2 minutes is the "grace period" allowance for reinsertion of integrals removed by mistake)

NOTE

If more than one integral is loaded for the same assay, the usage is prioritized as follows:

- a) Integrals with shorter magnetic particle agitation time remaining are used first***
- b) Integrals are used from left to right***

12.2.2 [Reagent Integral Data] section in detail

This area displays the assay data of the selected (dark gray color) reagent integral (see Fig.12.2.2-1).

Fig.12.2.2-1: [Reagent Integral Data] section

The screenshot shows the 'Reagent Integral Data' section with the following fields and values:

- Article-No: 028
- Kit-No: 0004
- Integral Layout: 7
- Master Curve ID: 2011102316330
- Lot-No: 026111101
- Expiry Date: 2012-10-31
- Determinations: 100
- Remaining Tests: 100

The 'Calibrators' section includes:

- Units: IU/mL
- 1: 9.46
- 2: 459.86

The 'Tolerances' section includes two bar charts (RLU and Concentration) and a 2x2 grid of input boxes, all containing the value 70.

[Article-No]

This number is used for the identification of the integral. After the successful insertion of the integral (or the complete manual input of the integral data), the assay abbreviation is displayed on the integral button.

[Kit- No]

This number is an individual number assigned only once in each lot for each specific assay. The system uses this number to check whether the integral has already been loaded and how many determinations are already executed. The number of determinations still available is calculated and displayed accordingly.

[Integral Layout]

The integral layout is used for the identification of the placement of the component vials in the integral. Two types are available at present (07, & 08).

[Master Curve ID]

This field is the identification number of master curve of the assay.

[Lot- No]

Displays the number of the integral lot

[Expiry Date]

Displays the expiration date of the integral

[Determinations]

Displays the original number of determinations available for the integral

[Remaining Tests]

Displays the number of determinations still available for the selected reagent integral in Integral Area. The original number of determinations is part of the reagent barcode and is the initial value for this field when a reagent integral

is loaded for the first time.
The software keeps track of this number and updates the remaining tests according to the reagent usage.



For maintaining safety of the diagnostic result, the plain bar user against the presentation of barcode data on the screen of code information on the reagent integral is to be checked by the MAGLUMI Diagnostic System. [202; 097]

12.2.2.1 [Tolerances %] section in detail

This field displays the upper and lower tolerance ranges in percentage, for RLU and concentration of calibrator 1 and calibrator 2.

Fig.12.2.2.1-1: [Tolerances %] section

The screenshot shows a dialog box titled 'Tolerances:'. It is divided into two main sections: 'RLU:' and 'Concentration:'. Each section contains a bar chart with 10 bars of increasing height. Below each bar chart are four input fields arranged in a 2x2 grid. In the 'RLU:' section, the top row has two input fields, both containing '70', and the bottom row also has two input fields, both containing '70'. The same layout is repeated for the 'Concentration:' section, with all four input fields containing '70'.

The fields are enabled to allow a Double Blind Entry of the integral data

12.2.2.2 [Calibrators] section in detail

This dialog displays the Units and set values of concentration of calibrator 1 and calibrator 2.

Fig.12.2.2.2-1: [Calibrators] section

The screenshot shows a dialog box titled 'Calibrators:'. It contains three rows of input fields. The first row is labeled 'Units:' and has a single input field containing 'IU/mL'. The second row is labeled '1:' and has a single input field containing '9.46'. The third row is labeled '2:' and has a single input field containing '459.86'.

If an assay has external calibrators the values are displayed after pressing the <Start> button. See 12.2.3 [Calibration] section for details.

12.2.2.3 [Remaining Test] Double Blind Entry

Example *Double Blind Entry* Integral Data of [Remaining Test]

The field for the entry extends itself to the double height containing two entry fields and a dark gray colored frame

Fig. 12.2.2.3-1

Reagent Integral Data

Article-No:	<input type="text"/>	Kit-No:	<input type="text"/>	Integral Layout:	<input type="text"/>
Master Curve ID:	<input type="text"/>	Lot-No:	<input type="text"/>	Expiry Date:	<input type="text"/>
Determinations:	<input type="text"/>	Remaining Tests:		<input type="text" value="100"/>	

The keyboard focus is set to the upper field, enabling the user to enter the data. After the data has been entered, pressing "Tab" or "Enter" changes the cursor to the second field, altering the first input to a series of " * ".

Fig. 12.2.2.3-2

Remaining Tests:

After correct retyping the input is displayed

Fig. 12.2.2.3-3

Remaining Tests:

If the second input is not correct the field is displayed as **<ERROR!>**. Then these entries must be deleted and then the first and the second entry must be repeated.

Fig. 12.2.2.3-4

Remaining Tests:

If all inputs are done the integral is recognized and the entry fields become disabled, the field for the assay tolerances stay enabled for the access level - Super- (see Fig. 12.2.4-1)

12.2.3 [Calibration] section in detail

Calibrations are required for each integral, to determine the working curve based upon the environmental conditions. The calibrators are normally included in the integral (internal). There are however also calibrators that are delivered separately from the integral mostly due to stability of the calibrators (external)



The **[Calibration]** section of the **[Reagent Loading]** dialog is for accessing the **[Calibration Dialog]**, and starting calibrations.

The **<Start>** icon located here is only for the starting of calibrations (external or internal).

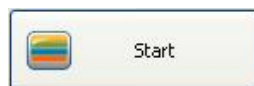
NOTE

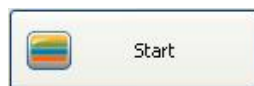
When starting a combi-assay calibration, the calibration of combi-partner A is carried out and displayed in the [Calibration Dialog] dialog box.

Fig. 12.2.3: **[Calibration]** section

 Start	Pressing this icon starts the calibration	12.3.1[Calibration] <Start> in detail
 View	Pressing this icon displays the Sample- ID and the Assay List On the right side	12.3.2 [Calibration] <View> in detail

12.2.3.1 [Calibration] icon <Start> in detail



Pressing the icon  starts a calibration of the actual selected integral (dark gray color). The button is disabled if a not readable **[ERROR]** integral is selected in the **[Reagent Loading]** dialog.

12.2.3.2 [Calibration] icon <View> in detail

The <View> icon allows the user to enter into the **[Calibration Dialog]**. In this dialog the user can:

- Validate a calibration (working curve)
- Reject a calibration (working curve)
- Recalculate all associated samples (sample results that have been produced using the reagents in that particular integral)
- Print calibration information
- Recalculate a working curve (view a working curve on the graph)




Pressing the icon  opens the **[Calibration Dialog]** (see Fig.12.3.2-1)

Fig.12.2.3.2-1:**[Calibration Dialog]**

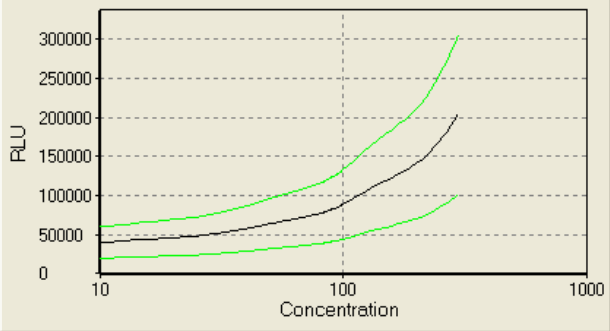
Calibration Dialog: TRAb

Expires: 2010-02-12 15:48:24

Last Run: 2010-04-01 19:16:27

Mastercurve ID: 009081207

Validate Recalc associated samples Reject



Geometric curve check

A: 43911 Ratio: 3.155

B: 138528 Minimum: 0 Maximum: 100

Status: Calculated

Activity: Finished

	Calibrator 1	Calibrator 2		
RLU				
	43921	138528		
	43921	138528		
	43921	138528		
Mean	43921	138528		
CV	0.000	0.000		
Dev[%]	0.023	0.000		
Concentration				
Expect	15.298	196.102		
Calcul.	15.298	196.102		
Dev[%]	-0.000	-0.000		
Tolerances				
	-%	+%	-%	+%
Conc.	50	50	50	50
RLU	50	50	50	50

OK





Cancel

Help

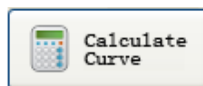
Calculate Curve

Print

CHANGE CALI.

 OK	Confirms (Calculate Curve, Validation, Recalc associated, samples, Reject) and closes the dialog	
 Cancel	Discards changes and closes the dialog	
 Calculate Curve	Curve will be calculated if all tolerances are in range	12.2.3.2.1 [Calibration Dialog] icon <Calculate Curve> in detail
 Print	Prints the calibration data	12.2.3.2.2 [Calibration Dialog] icon <Print> in detail

12.2.3.2.1 [Calibration Dialog] icon <Calculate Curve> in detail



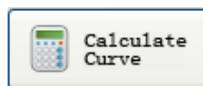
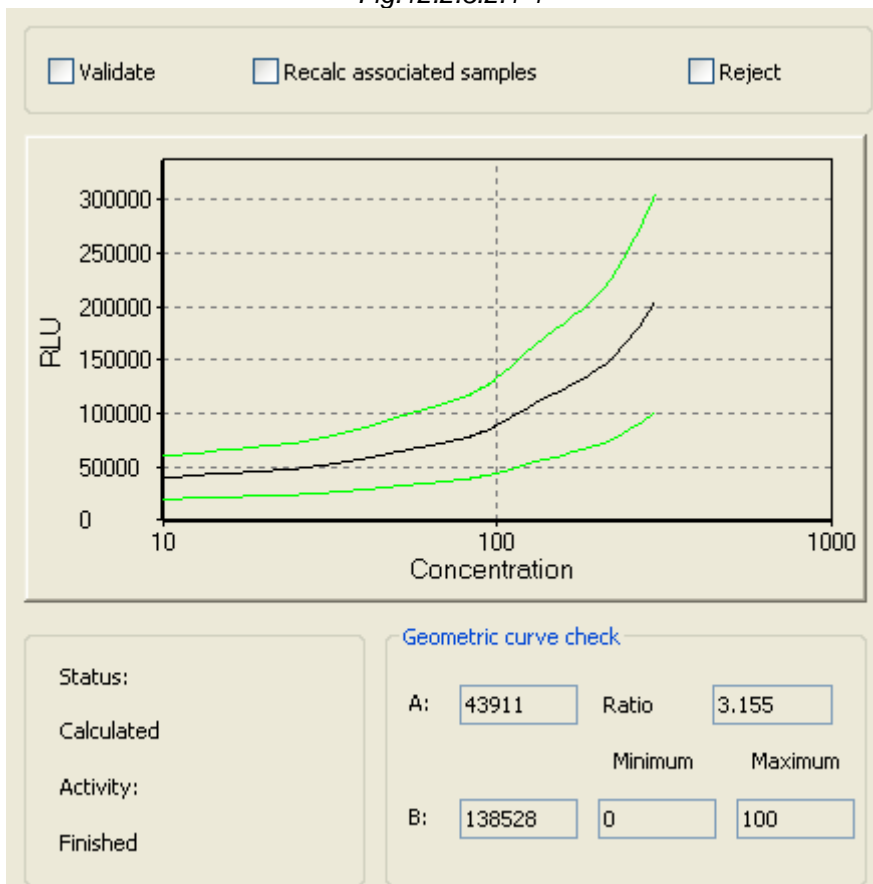
Pressing the icon  calculates the measured working curve if all tolerances are in range. The working curve (including the green calculated tolerance belts and the Status and Activity of the integral) is displayed (see Fig 12.3.2.3-1)

Fig.12.2.3.2.1-1

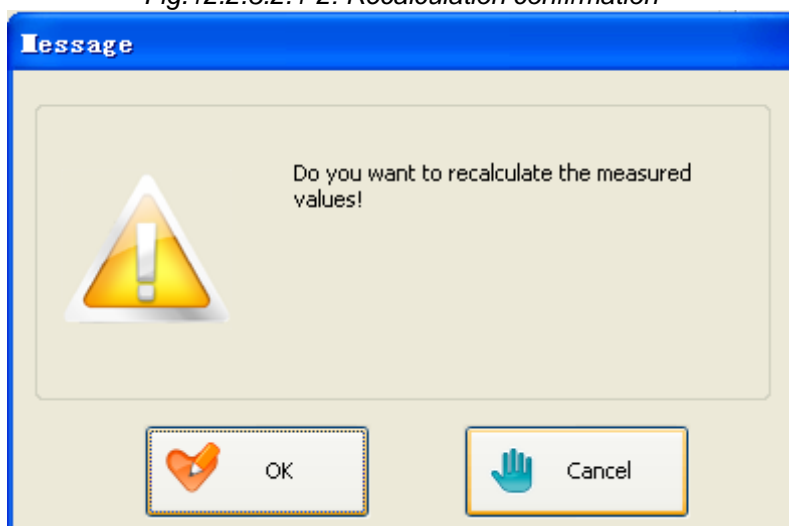


If **Validate** is checked , the calibration result is accepted and the calibration declared valid.

If **Reject is checked** , the calibration result is rejected

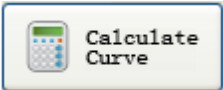
If **Recalc. associated samples** is checked , all results processed from this integral are calculated on the displayed validated calibration after confirming the message:

Fig. 12.2.3.2.1-2: Recalculation confirmation



Status shows the status of the working curve. The options are:

Calculated the working curve has been calculated by

pressing the  icon.

Not Validated the working curve has been rejected by checking the **[Reject]** box and confirming with **<OK>**.

Validated the working curve has been calculated and validated

Activity shows the action that has been taken before or after a validation. The options are:

Finished the calibration has been completed and results are available

Pending a calibration is active but no results are available

All results measured All results have been measured by checking the **[Recal. associated samples]** box and confirming with **<OK>** or after a rejection of a working curve. (This passage appears when all steps have been taken and no additional steps are necessary)

12.2.3.2.2 [Calibration Dialog] icon <Print> in detail



Pressing the icon allows the user to print the calibration data. Display of information about: Master curve ID, Lot Number, Kit Number, Expiration date, Execution date, Calibration Status, RLU's, Concentration, Geometric Curve Check and the Working Curve are printed

12.2.3.2.3 [Calibration Dialog] Expires/ Last Run

This display is located in the upper center part of the dialog:

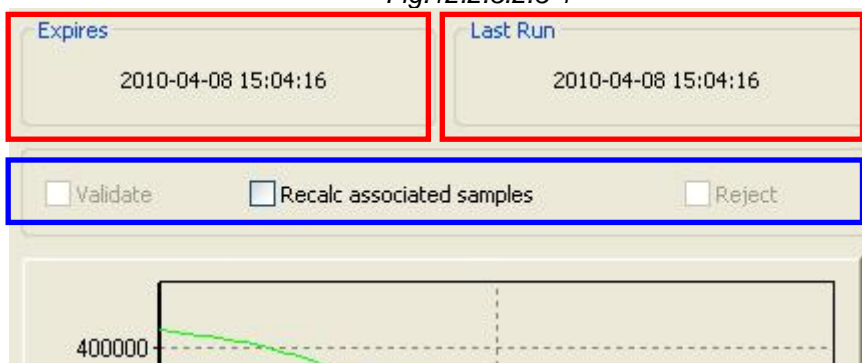
Expires:

This field depicts the expiry date and time of the actual working curve

Last run:

This field depicts the date and time of the last validated measurement of the working Curve (see Fig.12.3.3-1)

Fig.12.2.3.2.3-1



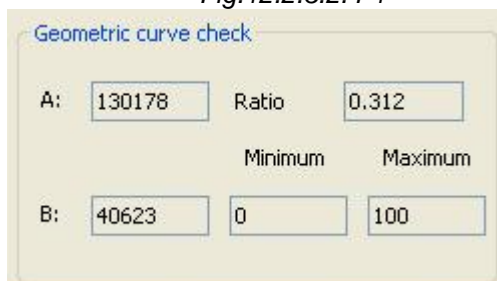
12.2.3.2.4 [Calibration Dialog] Geometric Curve Check

If a geometric curve check is predefined for an assay, it will be calculated after pressing <Calculate Curve>.

The check is performed as an additional disqualification criterion for a working curve.

A "Ratio" is calculated (B/A) and compared with a predefined range. In case that the fields are empty, no check is performed (see Fig.12.3.4-1)

Fig.12.2.3.2.4-1



A calibration cannot be validated if the ratio is out of range (Min./Max). If this is the case, it will be displayed on a red background.

12.2.3.2.5[Calibration Dialog] Working Curve Information

On the right side of the **[Calibration Dialog]** all information regarding the working curve are displayed (see Fig.12.3.3-1).

Fig.12.2.3.2.5-1

Mastercurve ID:		20100207120900			
	Calibrator 1	Calibrator 2			
	RLU				
	<input type="text" value="126522"/>	<input type="text" value="43870"/>			
	<input type="text" value="134316"/>	<input type="text" value="37377"/>			
	<input type="text"/>	<input type="text"/>			
Mean	<input type="text" value="130419"/>	<input type="text" value="40623"/>			
CV	<input type="text" value="4.226"/>	<input type="text" value="11.301"/>			
Dev[%]	<input type="text" value="-50.587"/>	<input type="text" value="-62.779"/>			
Concentration					
Expect	<input type="text" value="2.325"/>	<input type="text" value="32.256"/>			
Calcul.	<input type="text" value="2.299"/>	<input type="text" value="32.256"/>			
Dev[%]	<input type="text" value="-1.133"/>	<input type="text" value="-0.000"/>			
Tolerances					
	-%	+%	-%	+%	
Conc.	<input type="text" value="50"/>	<input type="text" value="50"/>	<input type="text" value="50"/>	<input type="text" value="50"/>	
RLU	<input type="text" value="50"/>	<input type="text" value="50"/>	<input type="text" value="50"/>	<input type="text" value="50"/>	

[Mastercurve ID]

Display of Mastercurve ID

[Calibrator 1] [Calibrator 2]**[RLU]**

Display of the measured RLU's in the associated columns of the two calibrators

[Mean]

Display of the mean value of duplicates or triplicates

[CV]

Display of the coefficient of variation of duplicates or triplicates

[Dev (%)]

Display of the percentage deviation from the set value

[Concentration][U/ml]

Display of the details of the concentration in the assay relevant unit

[Expect]

Set values of the calibrator concentration

[Calcul.]

Calculated concentration values using the measured RLU's of the last

validated working curve

[Dev (%)]

Percentage deviation between set value and calculated values

[Tolerances]

Percentage tolerances given by the reagent manufacturer for the calculated concentrations and the measured RLU's of the calibrators

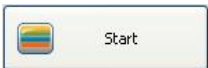
12.2.3.2.6 [Calibration Dialog] How to calibrate & validate an integral


This section instructs the user on calibration procedures.

Ensure the integral has been inserted into the analyzer a minimum of 30 minutes.

If the integral has external calibrators, they must be inserted according to chapter 15.

1. Enter into the **[Reagents]** dialog and select the integral to be calibrated.

2. Press  in the **[Calibration]** area to start integral calibration.

3. When the calibration (right LED is green) has been completed, press  in the **[Calibration]** area to enter into the **[Calibration Dialog]** and define the **"Working Curve"** (representing the results of the calibration).

The **[Calibration Dialog]** window appears:

Calibration Dialog: AFP

Expires: 2013-02-08 11:45:57

Last Run: 2013-01-11 11:45:57

Mastercurve ID: 20120927010101

Calibrator 1: 38603, 37770, Mean: 38186, CV: 1.542, Dev[%]: -4.849

Calibrator 2: 965328, 894189, Mean: 929758, CV: 5.410, Dev[%]: 10.330

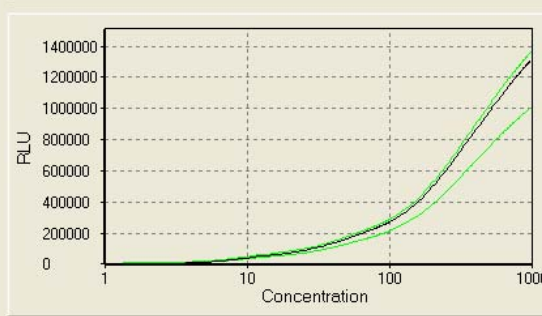
Concentration: Expect: 9.46, Calcul.: 9.460, Dev[%]: -0.000

Concentration: Expect: 459.86, Calcul.: 459.860, Dev[%]: -0.000

Tolerances:

	-%	+%	-%	+%
Conc.	15	15	15	15
RLU	15	15	15	15

Validate Recalc associated samples Reject



Geometric curve check

A: 38156 Ratio: 24.367

B: 929758 Minimum: 0 Maximum: 100

Status: Validated
Activity: Finished

OK

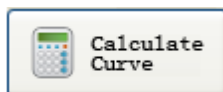
Cancel

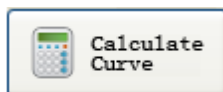
Help

Calculate Curve

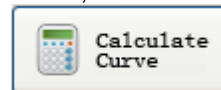
Print

Change Cali.



4. Press  to calculate and plot the "Working Curve" on the screen, highlighting all information related to the curve itself (if there is a previous calibration, the old working

curve will be displayed until the icon



is pressed).



The icon <Calculate Curve> must be pressed to view the new "Working Curve" in the graph display and calculate the concentration values.

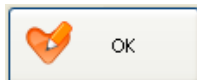
5. **At this point there are two options the user may choose:**
- Accept the calibration (proceed to Step 6)
 - Reject the calibration (follow the instructions below)

The acceptance of the calibration is dependent on the user but also on the following:

Geometric curve check
RLU Deviation (%)
Concentration Deviation (%)

If any of the above three fields are red in background, the calibration should be rejected and not validated.

Check the box beside **[Reject]** and confirm with the

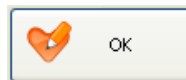


icon.

The calibration must be restarted.

Validating a Working Curve

- Check the box beside **[Validate]** to accept/validate the calibration.
- Check the box beside **[Recalc Associated Samples]** to all samples that have run from that same integral (including the current calibration results found in the **[Daily Lab Journal]**).



- Confirm with the  icon.

- A confirmation window will appear for recalculation of measured samples. Confirm this window with **<OK>**.

The newly plotted "Working Curve" is then rendered valid and active.

It is possible to print a "Calibration Report" by pressing the





icon.

12.2.4 Exiting, Confirmation, & information

The non-sectioned portion of the [Reagent Loading] dialog is for the user to exit the dialog (<OK>) or view information (<Help>) (see fig.:12.2.4 exiting, confirmation, & information).

Fig.: 12.2.4 exiting, confirmation, & information



	OK	This icon is used for exiting the dialog provided the reagent flap on the analyzer is closed.	12.2.4.1 [Reagent Loading] dialog, <OK> icon
	Help	Function not implemented	

[Reagent Loading] dialog, <OK> icon



Pressing the icon from the [Reagent Loading] dialog exits the dialog and returns to the [Main Menu] dialog. This icon serves only as an exit button.

Chapter 13

Consumable Handling

13.1 Consumable handling in overview -----	2
13.2 Consumable handling instructions-----	2
13.2.1 Reaction Module handling -----	2
13.2.2 Analyzer Liquids handling -----	4
13.2.3 Waste Disposal -----	9
13.2.4 Light Check Handling -----	10

13.1 Consumable handling in overview

In order to ensure dependable and constant reproducibility, the regular handling of consumables on the MAGLUMI® analyzer must be achieved according to referred instructions.

The MAGLUMI® consumable handling instructions are listed in this chapter as well as in the instructions for use (IFU) of each particular consumable item.

All instructions should be read thoroughly before the analyzer is started.

Handling procedures on the MAGLUMI® 600/800 analyzer must be performed only by authorized persons.



For maintaining safety, the MAGLUMI Diagnostic System may only be run with consumables (cuvettes, wash buffer, system liquid, containers and waste bags) approved by SNIBE Co., Ltd Only un-used, non-contaminated cuvettes may be used.

13.2 Consumable handling instructions

The consumable handling instructions are divided into four sections:

1. Reaction module handling
2. Analyzer Liquids handling
3. Waste disposal
4. Light Check

CAUTION

Always ensure that system reservoirs are adequately full and all wastes are sufficiently empty before starting a cycle!


13.2.1 Reaction Module handling

Reaction modules are plastic containers with 6 cavities each where the sample reaction occurs and is measured.

Reaction modules are never to be stored in direct sunlight.

Storage temperature is 15 – 30° C.



The main menu shows a system reservoir icon  to indicate whether the reservoir is adequately full. When this icon is pressed, the **[Reservoir Status]** dialog box provides information about the exact reservoir status of reaction modules, starter reagents, wash / system liquid.

Procedure for replenishing reaction modules:

1. Open a pack of MAGLUMI® Modules as directed and remove a set (min. 4 - max. 8) of reaction modules from the pack.
2. Manually insert the cuvettes to the incubator locade on the left side of analyzer. Make sure each cuvette should be inserted completely.

3. The analyzer will automatically correct the cuvette position which is present in the incubator.
4. Repeat this process until the incubator is sufficiently full. Its maximum capacity is 10 reaction modules.



Ensure that reaction modules are placed into the incubator exactly as pictured in figure 13.2.1-1.

CAUTION

The incubator can only be loaded after all the tests are finished on board.

Fig. 13.2.1-1: loading reaction modules for Maglumi 600.



When an analyzer stop is actuated by the system reservoir running out, all samples currently being processed revert from the [active] status to the [placed] status. After replenishing the system reservoir, these samples must be restarted. After starting, check the status of the samples still to be processed in the [Daily Lab- Journal].

NOTE

Please comply with the storage and manufacturer's directions included in the package information for the reaction modules (MAGLUMI® Module).

13.2.2 Analyzer Liquids handling

Analyzer system liquids are defined as the chemicals needed to operate the instrument. They consist of “MAGLUMI® Wash / System Liquid”, “MAGLUMI® Starter 1”, & “MAGLUMI® Starter 2”. Only SNIBE Co., Ltd. approved liquids are to be used on the MAGLUMI® 600/800 analyzer.



Avoid all contact with skin and mucosa.

Always ensure that system reservoirs are adequately full before starting a cycle!

13.2.2.1 MAGLUMI® Wash/System Liquid

The supply connections for wash / system liquid (MAGLUMI® Wash/System Liquid) are located on the right side of the analyzer and are labeled as follows (see fig 13.2.2.1-1):

- | | |
|------------------------|--|
| [System Liquid] | supply connection for cleaning the pipetting needles and flushing the hose system. |
| [Wash Liquid] | supply connection for washing the magnetic particles. |

Fig. 13.2.2.1-1 System Liquid connections.



MAGLUMI® Wash/System liquid is used for both connections and in most MAGLUMI® hardware configurations 1 supply container is used

for both connections. A second supply container is provided for the pre-preparation of system / wash liquid.

MAGLUMI® Wash/System liquid should be kept away from direct sunlight. Storage temperature is 15 – 30° C.

The wash / system reservoirs are monitored by a level meter and



indicated by 'traffic signals' on the system reservoir icon.

When this icon is pressed, the **[Reservoir Status]** dialog box provides information on the exact reservoir status of reaction modules, starter reagents, wash / system liquid.

CAUTION

The pipetting of new samples is stopped or a cycle is not started if the wash / system liquid reservoir is empty.

CAUTION

Press the icon to check which reservoir is running out and take appropriate countermeasures

NOTE

There is no loss of either reagent or data when the analyzer is stopped by an empty system reservoir.



When an analyzer stop is actuated by the system reservoir running out, all samples currently being processed revert from the [active] status to the [placed] status. After replenishing the system reservoir, these samples must be restarted. After starting, check the status of the samples still to be processed in the [Daily Lab- Journal].

Preparation & Substitution Procedures:

Prepared MAGLUMI® Wash/System liquid is stable for a period at least of 4 weeks at 15 – 30° C.



MAGLUMI® Wash/System liquid must fulfill the requested ambient operating conditions while installation and should never be used after defined expiry date for onboard stability.



The wash / system liquid can be exchanged only when the analyzer is inactive!.

Preparation

1. Fill an empty, clean container marked "System Liquid" or "Wash" with about 3.5 liters (Dilution rate Wash Concentrator : Distilled water=1:13) of distilled water (use only fresh water defined according to NCCLS guidelines for laboratory water "**Type III**" [**<10 µs / cm**])
2. Add the contents of one (1) bottle of MAGLUMI® Wash/System Liquid, in a fluid slow motion to avoid the formation of foam.

3. Using the cap of the bottle (with siphon tube/level sensor), gently stir the liquid and water solution again avoiding the formation of foam.
4. Placing a normal cap on the container, the prepared container must set isolated (without connecting to the instrument.) for a period of no less than 6 hours.
5. If pooling is achieved, it must be accomplished while the analyzer is inactive & in accordance with point 4.

Substitution

1. Remove the cap with level sensor and hose from the reservoir canister.
2. Open the new container and place the cap with level sensor and hose on the full container.
3. To fill the hose system, select **<System Test>** in the main menu. The **[System Test]** dialog box appears. Select the (✓) **[Washer]** and (✓) **[Pipettor]** option (indicated with a check sign). Change the values from "3" to "10".
4. In the **[Reaction modules]** area, set all the pre-settings (1) to zero (0) and press **<OK>** to start the flushing process (see_chapter 9 **[System Test]**).

NOTE



Please comply with the storage and manufacturer's directions included in the package information for the wash / system liquid (MAGLUMI® Wash / System Liquid).

Freshly prepared or not degassed system liquids should never be used in the MAGLUMI Diagnostic System.

13.2.2.2 Starter Liquid


The starter reagent box containing the starter reagent bottles is located on the right inner side of the analyzer. The yellow rings of hose connected the starter container are marked as follows:

- | | |
|-----|--------------------|
| [1] | MAGLUMI® Starter 1 |
| [2] | MAGLUMI® Starter 2 |

The numbers "1" and "2" refer respectively to starters 1 and 2. The container is provided with removable screw covers with a hose connection that is color-coded to match the starter reagent position. The filling level of starter reagents is monitored by a capacitive probe located in the filler cap. The starter reagent box is secluded by a removable cover and should be replaced when not exchanging starter reagent bottles.

MAGLUMI® Starter Kit should be kept away from direct sunlight. Storage temperature is 15 – 30° C. Please comply with the storage and shelf life information for the starter reagents (MAGLUMI® Starter Kit)!

The starter reagent reservoirs are monitored by a level meter and

indicated by 'traffic signals' on the system reservoir icon . When

this icon is pressed, the **[Status Reservoir]** dialog box provides information on the exact reservoir status of reaction modules, starter reagents, wash / system liquid. (See Chapter 5.4.1 for details).



When an analyzer stop is actuated by the system reservoir running out, all samples currently being processed revert from the [active] status to the [placed] status. After replenishing the system reservoir, these samples must be restarted. After starting, check the status of the samples still to be processed in the [Daily Lab- Journal].

CAUTION

The pipetting of new samples is stopped or a cycle is not started if the starter reagent liquid reservoir is empty.

CAUTION

Press the icon to check which reservoir is running out and take appropriate countermeasures

NOTE

There is no loss of either reagent or data when the analyzer is stopped by an empty system reservoir.

Exchanging starter reagents

The chemical substances included in the Starter Reagents can cause chemical burns when coming in direct contact to the skin. Before the Starter Reagents are handled or loaded into the Analyzer the package information for the starter reagents (MAGLUMI® Starter Kit) is to be read thoroughly and followed by the user.



The chemical substances included in the Starter Reagents can cause chemical burns when coming in direct contact to the skin. Before the Starter Reagents are handled or loaded into the Analyzer the package information for the starter reagents (MAGLUMI® Starter Kit) is to be read thoroughly and followed by the user.

The starter reagents can be exchanged only when the analyzer is inactive!

Do not spill liquid in this area!

It is essential to ensure correct connection to starter 1 and Starter 2.



- **The starter reagents can be exchanged only when the analyzer is inactive!**
- **Do not spill liquid in this area!**
- **It is essential to ensure correct connection to starter 1 and Starter 2.**

Procedure:

1. Unscrew the screw connection of the starter 1 container and remove it together with the hose connection.
2. Remove the container and place the full starter 1 container in the relevant position.
3. Place the screw connection on the container and screw it on.
4. Repeat procedures 1-3 with the starter 2 containers.
5. The hoses of the starter reagents are color-coded. It is essential to ensure correct container connections.
6. Position the light check solution in the sample rack (Type L) and program this in the sample load dialog (see chapter 9 **[System Test]**).
7. Select **<System Test>** in the main menu to fill the hose system followed by background and light check measurement. The **[System Test]** dialog box appears. Select only the (✓) **[Chamber Set A or B]** option (indicated with a check sign).
8. Change the value from "3" to "10", and press **<OK>**, to start the flushing process followed by background and light check measurement (see chapter 9 **[System Test]**).



Starter reagent pooling is not allowed under any circumstances. (See label in Fig 13.2.2.2-2)

Fig 13.2.2.2-1 "No Starter Pooling" label



Always keep the starter reagent area covered with the supplied cover to avoid light



In case batch numbers of old and new Starters differ, it is necessary to recalibrate all integrals.

NOTE

Please comply with the storage and manufacturer's directions included in the package information for the starter reagent (MAGLUMI® Starter 1, & MAGLUMI® Starter 2).

13.2.3 Waste Disposal



Disposal must be carried out according to the currently valid domestic regulations. Adequate protection must be worn when disposing of all waste materials.

Before and during operation of the MAGLUMI® Analyzer, provision should be made for appropriate disposal of the used reaction modules and liquid waste!

Waste bags for reaction modules

The holder for the waste bag (MAGLUMI® Waste Bag) for used reaction modules is located on the right side of the analyzer next to the measuring chamber.



Ensure that the waste bag is correctly fitted in and underneath the holder; otherwise the analyzer may stop due to jamming of the following of reaction modules at the edge of the waste bag

When the waste bag is full, it can be removed from the holder and sealed with the cover provided.



The reaction modules come into contact with potentially infectious material and must therefore be appropriately disposed of in the waste bag (MAGLUMI® Waste Bag).

Liquid waste

The two drain connectors for waste 1 and waste 2 for liquid waste are located on the right side of the analyzer next to the supply connectors for wash / system liquid (see fig 13.2.2.1-1).

Waste 1 (chemical waste)

Chemical waste comes from the measuring chamber and contains magnetic particles and starter reagents.

Waste 2 (biological waste)

Biological waste comes from the pipetting system and from the washer and contains wash / system liquid and liquid from the reaction modules (patient samples, assay reagents).

The cap of the disposal canisters includes a level monitoring device. The reaction modules waste is equipped with a counter that must also be reset when the waste bag has been replaced. The complete waste status can be viewed via **<Waste>** icon in the main menu of the software. (See chapter 5.4.3)

The waste canisters must be cleaned regularly according to the proper maintenance procedures.

13.2.4 Light Check Handling

Light Check reagent contains a lyophilized material that, when mixed with the proper amount and type of water, issues a predetermined value when run on the MAGLUMI® analyzer. It is required when running a system test on the analyzer (see chapter 9)

Light Check must be accomplished under three circumstances:

- (1) Once daily prior to starting the first measurement series **or**
- (2) Each time a new lot of starter reagents is used **or**
- (3) During required maintenance.

The light check unopened and stored at 2-8 °C is valid for the storage life as written on the packaging.

A prepared Light Check stored at 2-8° C, is valid for 1 week from the date of preparation.

In any case, the Light Check should be kept away from direct light. After usage, immediately close the MAGLUMI® Light Check vial and refrigerate at 2 – 8 °C.

Handling procedure:

1. Remove a Light Check vial from its original package.
2. Carefully open the vial containing the lyophilized material
3. Using only fresh water, defined according to NCCLS guidelines for laboratory water (Type III), reconstitute lyophilisate by pipetting 2ml (\pm 20 μ l) water, into the original vial.
4. Do not shake, but rotate the vial carefully to mix the solution, being careful to avoid foam formation. Make sure that lyophilized material adherent to the caps is also dissolved.



The formation of foam or bubbles in the Light Check vial may jeopardize the results of the system test and therefore induce false diagnostics of the functionality of the analyzer.

5. Prior to use, the Light Check vial should stand for a minimum of 5 min. The Light Check should be run at room temperature.
6. Place the MAGLUMI® Light Check vial into the patient rack ensuring that the bar-coded side is facing the opening of the patient rack. (See fig 13.2.4-1).

Fig 13.2.4-1: Light Check inserted in a rack



For application of the MAGLUMI® System Test see chapter 9.

NOTE

Please comply with the storage and manufacturer's directions included in the package information for the light check (MAGLUMI® Light Check)

Chapter 14

Handling Reagents

14.1 Reagent handling in overview	2
14.2 Reagent Integrals in detail	2
14.2.1 Physical Construction of the Integral.....	2
14.2.2 RFID Chip of the Integral.....	3
14.3 Loading Reagents	4
14.3.1 Integral preparation	4
14.3.2 Placing integrals on the analyzer.....	5
14.3.3 Particular aspects of loading reagents in combi-assays	7
14.3.4 Removing integrals from the analyzer	7
14.3.5 Proper storage and handling of integrals	7
14.4 Manual loading of integrals	8

14.1 Reagent handling in overview

This chapter is to give the user basic instructions in reagent handling. This chapter will discuss, in reference, features of the software but basically refers to the physical handling of reagents and integrals.

The two types of delivered packages are Integrals and kits.

Integrals

consist of a package containing an integral and an IFU CD (or a written IFU document).

Kits

consist of integrals as described above including any external substances such as calibrators, or controls.

If special handling problems should arise that are not covered in this manual, it will be necessary to notify the local customer support center for assistance.

CAUTION

The performance of the diagnostic kit can be compromised by unsuitable Integral handling before loading, therefore the package information for the reagent integrals are to be read and followed thoroughly by the user.

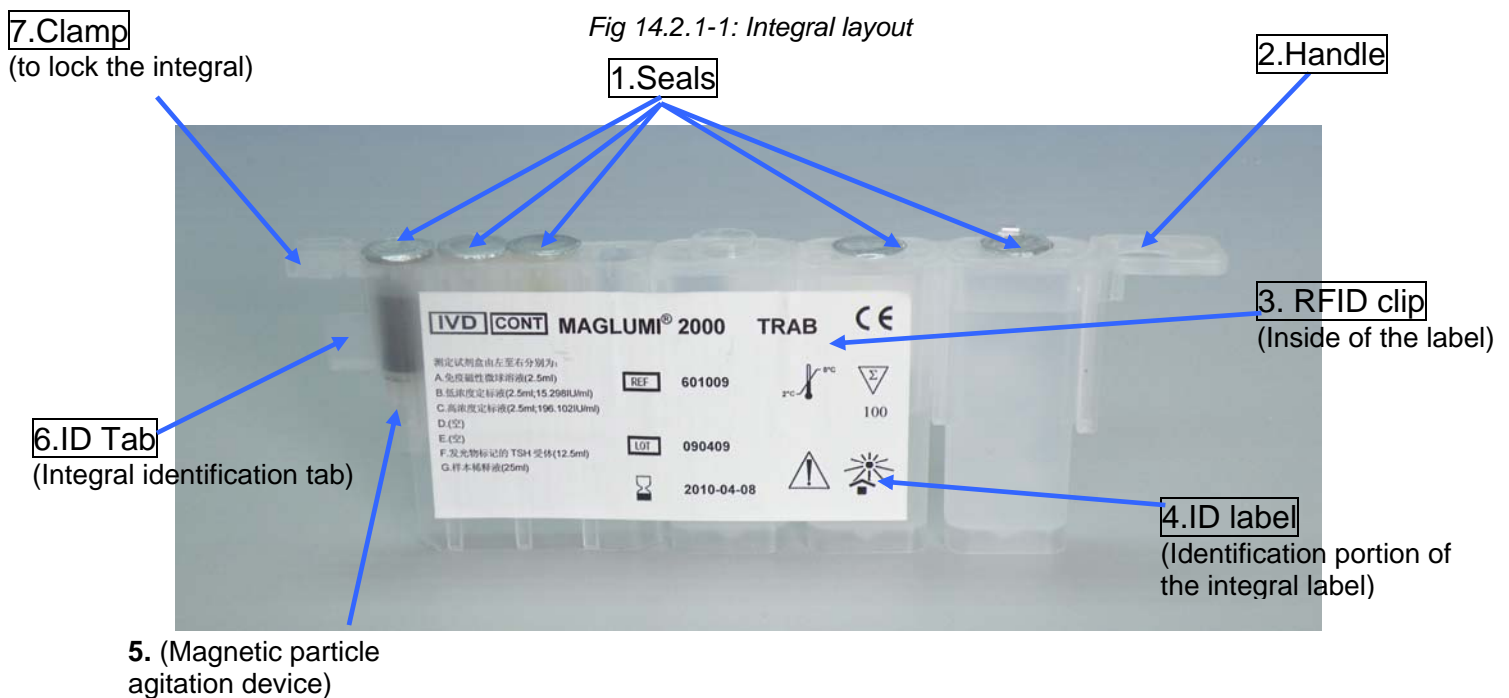
14.2 Reagent Integrals in detail

A reagent integrals is a pre-manufactured set of vials containing magnetic particles, tracer, buffer, and in most cases calibrator & diluter, that are set together in such a way as to perform a targeted reaction for a specific purpose.

14.2.1 Physical Construction of the Integral

All Integrals have the same setup as pictured in the figure below (with some exceptions).

Fig 14.2.1-1: Integral layout



The physical construction of the integral is as follows:

1. Entry point for the aspiration of liquid by the analyzer probes (needles).
2. Handle for inserting and removing the integral from the reagent area.
3. Barcode of the integral (see below)
4. Readable identification label of the integral
5. Geared form rotating vial for analyzer agitation of the magnetic particles.
6. Tab for determining the presence of an integral in the reagent area.
7. Clamp for correct position holding of integrals inside the reagent area.

14.2.2 RFID Chip of the Integral

The RFID chip of the integral is equipped with all information that the analyzer requires to properly identify and distinguish each integral as an individual item.

14.2.2-1 RFID Chip definition

Reagent Integral Data			
Article-No:	028	Kit-No:	0004
Master Curve ID:	2011102316330	Integral Layout:	7
Lot-No:	026111101	Expiry Date:	2012-10-31
Determinations:	100	Remaining Tests:	100
Calibrators:		Tolerances:	
Units:	IU/mL	RLU:	Concentration:
1:	9.46	70	70
2:	459.86	70	70

The information contained on the RFID chip of the integral is identified as follows:

[Art No.:]	article number or part number of the assay (test)
[Integral-No.:]	the number of the integral (also known as the kit number)
[Master Curve ID:]	the identification number of the reference master curve.
[Lot-No.:]	the lot number of the integral
[Assay protocol:]	the assay file name that is listed in the software (see chapter 7.2)

Symbols listed in the integral:

The pictured data describes the contents of the integral, storage information, identification, expiry date, etc. These symbols and their meanings are described in the IFU of each assay.

Although the above-mentioned elements are present in almost all integrals, the constitution (ingredients) will almost certainly not be the same between different assay types.



It is forbidden in ANY CIRCUMSTANCE to change the components of one integral to another even if the integral contains the same lot number

14.3 Loading Reagents

This section informs the user of proper loading of the integrals and is divided into the following sub-sections:

- Integral preparation
- Placing integrals on the analyzer
- Loading reagents in Combi-assays
- Removing integrals from the analyzer
- Proper storage of integrals



Integrals may contain either chemical or bio hazardous materials or both. Gloves must be worn at all times during reagent handling.

14.3.1 Integral preparation

Before the integral is utilized by the user, it must first be prepared. The preparation for the integral includes also the pre-storage of the integral. The instructed markings on the packaging box of the integrals must be strictly followed.



Failure to follow “on the box” instructions may result in rapid deterioration of integral life or even immediate expiration of integral components.

Ensure the integral was stored according to the arrows at the end of the shipping box. See fig 4.3.1-1 Integral direction markings. The arrows should always point upward. Never store the integral in a position other than noted. Never shake an integral. If an integral is to be used that has been stored improperly, then that integral will require special attention upon opening.

1. Remove the wished integral from the refrigerator keeping the integral in an upright position at all times.
2. Open the shipping box containing the integral and remove the integral.
3. Visually inspect the integral vials for leaking at the membrane seals or elsewhere. If the vials are leaking from anywhere the local customer service should be notified immediately.

4. Visually inspect the integral vials for bubbles. If bubbles are present the integral cannot be immediately used. The integral must either set until all bubbles resolve, or the bubbles must be removed before usage. (If bubbles are removed, it is important not to cross contaminate vials)
5. Gently rotate the magnetic particle vial to ensure free movement.
6. Carefully remove the sealing flap of each vial by pulling the tab of the seal across the membrane in a slow fluid motion (pull only the tab in order to prevent cross-contamination of the reagent integral vials).
7. Remove all liquid from the surfaces of the membranes to prevent cross contamination of the reagent integral vials.

14.3.2 Placing integrals on the analyzer



When placing integrals on the analyzer, the software and analyzer must be on. If one of these items is switched off, the inserted integral will not be registered and therefore will not run.

When placing integrals on the analyzer it is important to ensure that only the reagent area flap is open. Close the patient area flap before opening the reagent area flap and ensure all status bar windows are closed.

1. Open the flap of the reagent area on the analyzer.
2. Place the RF chip side of the integral close to the RF reader reading area. Hold for more than 2 seconds. The integrals' information will be read by the RF reader. If correctly, buzzer should generate a short sound. If incorrectly, it will beep twice. Remove the integral away from the reading area and try again.
3. Choose an unoccupied lane to insert the integral into.
4. Using a smooth motion, insert the integral into the reagent area until it rests firmly against the docking pins located in the rear of the reagent area. When the insertion has been achieved correctly, the integral will appear in the reagent area dialog (see chapter 12 for details).

Fig. 14.3.2-1: Introducing an integral



14.3.3 Particular aspects of loading reagents in combi-assays

When inserting the Reagent Integral of a combi-assay followed by the assignment of this assay to a sample, three measuring results can be obtained: those of the two combi-partners and that of the combi-assay.

14.3.4 Removing integrals from the analyzer

Close the patient area flap before opening the reagent area flap and ensure all status bar windows are closed.

When removing integrals from the analyzer, the software and analyzer must be on in order to register the proper removal of the integral.

The integral to be removed must not be active or have any results pending (refer to chapter 12 for integral status identification). The results and/or the performance of the analyzer can be jeopardized if an active integral is removed.

1. Open the reagent area flap or press the **<Reagents>** icon in the software **[Main Menu]**.
2. Insert one finger into the reagent handle or grab the reagent integral handle with thumb and forefinger and pull firmly and evenly until the integral is free of the docking station.
3. Carefully remove the integral keeping it in an upright position.

If the integral is empty

4. Discard of the integral in an appropriate manner.

If the integral is not empty

5. Place the integral in an integral tray in an upright position (if available).
6. Place the integral tray into the refrigerator (see storage information in the integral IFU).
7. If an integral tray is not available, place the integral into the refrigerator in a secure upright position.

14.3.5 Proper storage and handling of integrals

The following points should be adhered to in order to ensure a failure free functionality of the integral in conjunction with the analyzer.

- Integrals should always be stored in an upright position from 2 to 8° C.
- If integrals have been opened, they must be covered during storage to prevent evaporation of liquid in the vials.

- Integrals should never be shaken to prevent the formation of bubbles inside the vials.
- A waiting time of 30 minutes is required upon integral insertion into the analyzer to ensure proper mixing of the magnetic particles. A counter is displayed for this purpose (see chapter 12.2.1.4 **[Reagent Integral Area]** integral time counter status definitions).
- Integrals should never be inverted.

14.4 Manual loading of integrals

If a RFID chip of an integral cannot be read for some reason (i.e. defective RFID chip, improper functionality of the RFID reader) it will be necessary for the user to enter the chip information manually (integral information is located on the IFU delivered with the integral).

The detection of a non-readable RFID chip can only be determined when following the steps in 14.3.2 and the analyzer produces constantly two beeps upon integral touching, and the word **[ERROR]** appears in the reagent loading dialog as the assay name for this integral.

If the above-mentioned situation should apply, manually enter the information of the integral indicated by its IFU (If a written IFU is not present or notify the local customer service headquarters).

Chapter 15

Handling Patient Samples

15.1 Patient sample handling in overview	2
15.2 Sample racks in detail	2
15.2.1 Physical construction of the sample rack.....	2
15.2.2 Barcode layout of the sample rack.....	3
15.3 Loading samples	4
15.3.1 Sample rack preparation.....	5
15.3.2 Loading SNIBE External reagents in sample racks	7
15.3.3 Placing sample racks on the analyzer.....	7

15.1 Patient sample handling in overview

This chapter instructs the user in basic patient handling instructions. This chapter will discuss, in reference, features of the software but basically refers to the physical handling of patient samples and sample racks.

If special handling problems should arise that are not covered in this manual, it will be necessary to notify the local customer support center for assistance.



sample is to be only introduced in the MAGLUMI Diagnostic System in the sample tubes for the applied racks as defined in this Operating Instructions.



For maintaining traceability of the diagnostic results, the patient sample should be handled according to the laboratories quality system as described in the domestic requirements.

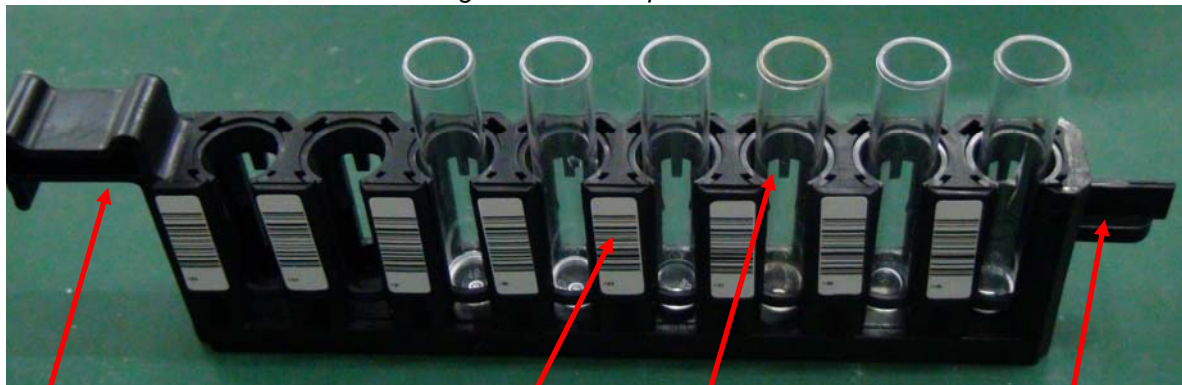
15.2 Sample racks in detail

A sample rack is defined as a device used to store patient samples (placed in sample tubes) for the duration of usage on the analyzer. The sample rack (also known as “patient rack” or “rack”) was designed to hold up to 8 sample tubes (bar-coded or non-bar-coded) and to be inserted into the analyzer in such a way as to be registered by the analyzer and support the sample tubes during aspiration of sample probes.

15.2.1 Physical construction of the sample rack

All sample racks have the same structure as pictured and described below. The positions are numbered from 1 through 8 with number 1 starting farthest away from the handle (position 1 in the picture is occupied by a vial of light check).

Fig 15.2.1-1: Sample racks



1. Sample handle

2. Bar-coded position detectors

3. Metal sample tube retainers

4. Clamp to lock the sample rack into the docking station

The physical construction of the sample rack is as follows:

1. Handle for inserting and removing the sample rack in/from the patient area. The Label identifies the rack type.
2. Bar-coded positions for each sample tube position to correctly recognize the position itself.
3. Clamp for correct position holding of sample tubes inside the sample racks.
4. Tab for determining the presence of a patient/sample rack in the patient area.

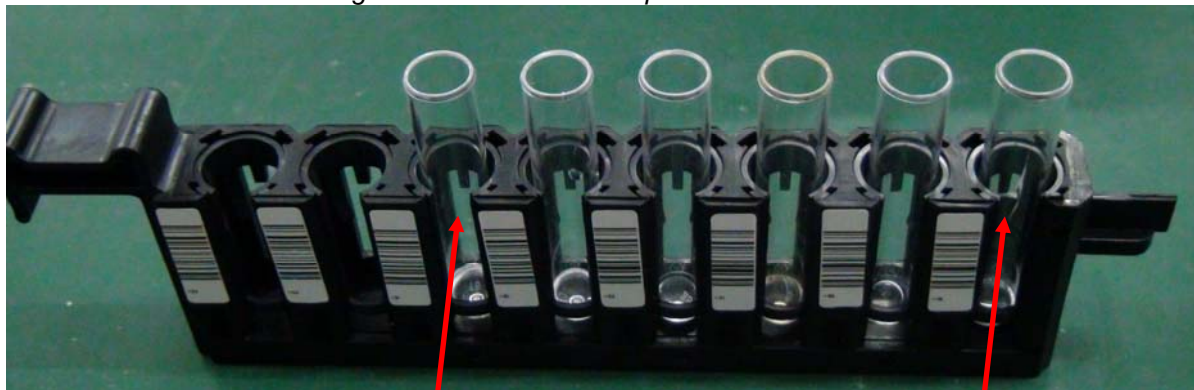
15.2.2 Barcode layout of the sample rack

The barcodes of the sample rack are placed to verify the actual position of each bar-coded sample tube. The system functions as follows:

The user inserts the sample rack into the patient area. Upon insertion of the sample rack, the barcode reader reads each bar-coded sample tube and immediately afterwards the position pertaining to this bar-coded sample tube. After the complete insertion of the sample rack, the software displays all barcode ID's in the correct rack position.

Example: A user has bar-coded sample tubes in positions 1-6 (See fig 15.2.2-1)

Fig 15.2.2-1 Bar-code sample tubes in a rack



Position#6









Position#1

As the user inserts the sample rack into the patient area the barcode reader recognizes the sample tube & position of each bar-coded tube. (See fig. 15.2.1-2).

Fig 15.2.1-2 Sample station example

Sample Info

From To

1		<input type="text" value="1"/>
2		<input type="text" value="2"/>
3		<input type="text" value="3"/>
4		<input type="text" value="4"/>
5		<input type="text" value="5"/>
6		<input type="text" value="6"/>
7		<input type="text" value="7"/>
8		<input type="text" value="8"/>

The positions 3 & 4 have sample tubes without barcodes and are therefore not assigned any automatic identification.

To reinforce this feature the software informs the user that not all positions were read as having a barcode and that the user must verify these positions.

All positions will contain an ID as read by the barcode reader except position 3 & 4.

15.3 Loading samples

This section informs the user of proper loading of the sample tubes into the racks and the sample racks into the analyzer and is described on the following pages.



Mechanical stress to the pipetting needle can provoke material breakage with the possibility of user injury; therefore ensure all sample tubes are uncapped before starting the MAGLUMI Diagnostic System.



The sample racks and the patient samples included in the Sample Tubes can be potentially infectious and therefore can deteriorate the health of the user. Gloves must be worn at all times during sample handling

15.3.1 Sample rack preparation

Before the sample rack is utilized, it must first be prepared.
See the preparation sub-topics below:

- Rack Type
- Dead Volume
- Sample Preparation

15.3.1.1 Rack Type

Now MAGLUMI analyzer using one type of racks.
It is compatible with glass or plastic tubes which inner diameter is form 12mm and larger.
Also it is compatible with SNIBE bar- coded glass vials (e.g. Light-Check)
Dead volume of 12mm inner diameter tube is 400µl when standing in the rack.

15.3.1.2 Dead Volume

The dead volume is the amount of liquid left in the sample tube that cannot be pipetted by the needle due to mechanical limitations and calculations. For each specific tube type exist a specific dead volume level. When an assay is run, the user must have a minimum of the sample amount needed plus the dead volume amount in order to run the assay effectively.

Example:

A user wants to run 2 samples of the test "MAGLUMI®T3" in a 12mm type sample tube.
According to the assay IFU - item 9, the assay requires 40 µl per sample. The user will have to have a total of 480 µl in the tube in order to ensure all samples will run without having any sample flags on the results.

Summary:

Rack	=	400 µl	dead volume
2 samples X 40µl	=	<u>80 µl</u>	usable sample volume
Total volume needed		480 µl	



In case of plasma gel separator containers, the amount of sample should be at least 500 µL plus the volume required to run the test.



Less or missing patient sample liquid will create compromised diagnostic results. Therefore, a warning message "No liquid level found" is displayed on the screen of the MAGLUMI Diagnostic System with an audible signal & the test must be repeated.

15.3.1.5 Sample preparation

Due to certain mechanical restrictions and safety precautions, the sample to be used on the MAGLUMI® analyzer must have the following characteristics:

Either human serum or plasma may be used.

The anticoagulants citrate, EDTA and heparin have been tested and may be used.

Blood should be collected aseptically by venipuncture, allowed to clot, and the serum separated from the clot as soon as possible.

Samples having particulate matter, turbidity, lipaemia, or erythrocyte debris may require clarification by filtration or by centrifugation before testing.

Grossly haemolyzed or lipaemic samples as well as samples containing particulate matter or exhibiting obvious microbial contamination should not be tested.

Check for and remove air bubbles before assaying.



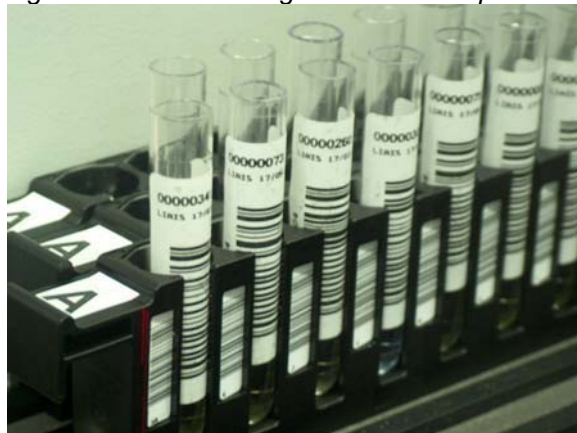
For maintaining safety, the samples must fulfill the requested installation and operating conditions, air bubble formation or clotting of the samples should be avoided.

After all criteria have been observed concerning the sample quality, the samples must be inserted into tubes and then into sample racks. The following procedure explains in detail the proper steps for doing so.

1. Insert the sample into a tube of choice provided the tube is within the specifications listed above.
2. Carefully insert the sample tube into the proper rack as instructed in the previous pages.
3. If the sample rack is bar-coded, the sample tube should be inserted so that the barcode is seen through the opening on the right side of the sample rack. (See figure 15.3.1.5-1 Inserting bar-coded sample tubes).

Note: MAGLUMI 1000 does not include the barcode reader.

Fig. 15.3.1.5-1: Inserting bar-coded sample tubes





Do not rotate bar-coded sample tubes after placement in sample racks. Rotating tubes when placed in sample racks may cause damage to the barcode and render the label unfit for future usage.



The position of the sample is never to be changed after introduction of the sample rack into the MAGLUMI® Analyzer.

15.3.2 Loading SNIBE External reagents in sample racks

SNIBE external reagents are known as the reagents that are delivered in vials such as light check, controls, external calibrators, and cleaning kit vials. An example of these vials is pictured in figure 15.2.1-1: Sample racks

Most SNIBE delivered vials (as pictured in the figure 15.2.1-1) are bar-coded; the vials should be inserted so that the barcode is seen through the opening on the right side of the sample rack. See figure 15.2.1-1: Sample racks. Manual entry of these vials should be accomplished according to chapter 11.



Do not rotate bar-coded vials after placement in sample rack. Rotating vials when placed in sample racks may cause damage to the barcode and render the label unfit for future usage.

If the vials have been inserted improperly, remove the vial and reinsert it in the correct manner.

15.3.3 Placing sample racks on the analyzer



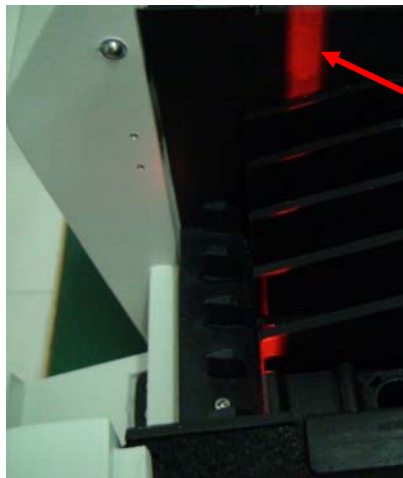
When placing sample racks on the analyzer, the software and analyzer must be on. If one of these items is switched off, the inserted sample rack will not be registered and therefore will not run.

When placing sample racks on the analyzer it is important to ensure that only the patient area flap is open. Close the reagent area flap before opening the patient area flap and ensure all status bar windows are closed.

1. Open the flap of the patient area on the analyzer.
2. Wait for the barcode beam to activate (as shown in figure 15.3.3-1 introducing a sample rack).
3. Choose an unoccupied lane to insert the sample rack into.
4. Holding the sample rack in an upright position at all times, set the edge of the sample rack on the edge of the patient area before an empty track ensuring the guide located on

the bottom of the sample rack is under the track rail. (See figure 15.3.3-2 rack insertion 1).

Fig. 15.3.3-1: Laser beam of Barcode reader



The barcode beam is identified as a thin red light.

Note: MAGLUMI 1000 does not include the barcode reader.

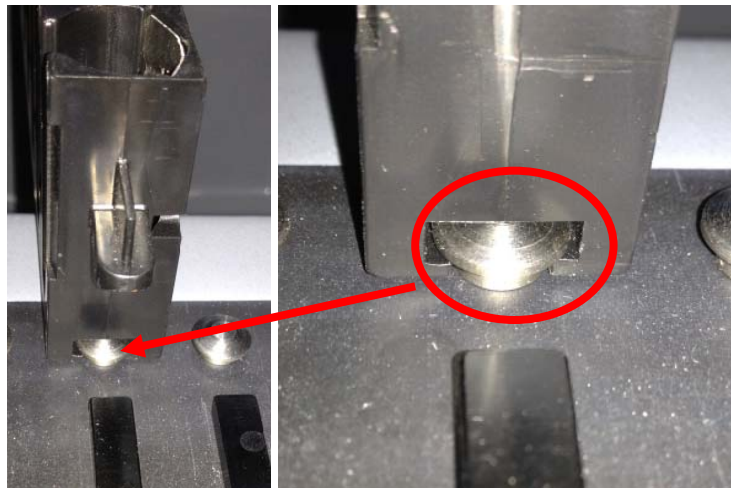


The barcode reader contains laser radiation. Never look directly into the laser beam.

5. Using a smooth motion, insert the sample rack into the reagent area until it rests firmly against the docking latch located in the rear wall of the patient area.

When the insertion has been achieved correctly, the barcode will beep once signifying a correct reading and the sample rack will appear in the **[Sample Loading]** section (see chapter 11 for details). If the analyzer beeps twice, step 4 & 5 must be repeated.

Fig. 15.3.3-2 rack insertion 1



15.3.4 Removing Sample racks from the analyzer

When removing sample racks from the analyzer, the software and analyzer must be on in order to register the proper removal of the sample rack.

The sample rack to be removed must not be active (Orange LED). The results and/or the performance of the analyzer can be jeopardized if an active sample rack is removed.

1. Open the patient area flap.
2. Grab the handle of the sample rack with thumb and forefinger and pull firmly and evenly until the sample rack is free of the docking station.
3. Carefully remove the sample rack keeping it in an upright position.

If the sample tubes are empty

4. Discard of the sample tubes in an appropriate manner.

If the sample tubes are not empty and will be used at a later date

5. Cover and store the patient sample according to laboratory regulations/specifications.
6. The sample racks may also be placed in an integral tray in an upright position (if available).
7. If an integral tray is not available, place the sample rack into the refrigerator in a secure upright position.



The diagnostic procedure of the MAGLUMI Analyzer could be interrupted by pulling the sample rack before terminating the analysis therefore never unload rack unless green LED is glowing.

Chapter 16

Host Result Management

- 16.1 Host Result Management in Overview 2
- 16.2 Host Setup in MAGLUMI® software 2
 - 16.2.1 ASTM Setup dialog 2
 - 16.2.2 Online icons in the MAGLUMI® software 3
- 16.3 Types of possible Host Connections in MAGLUMI® software 4
 - 16.3.1 Host Query 4
 - 16.3.2 How To send results to the LIS 5
- 16.4 MAGLUMI® software communication format 7
 - 16.4.1 Inquiry Reagent Information 7
 - 16.4.2 LIS return the assay information 8
 - 16.4.3 Sending test results 9

16.1 Host Result Management in Overview

In this chapter, we describe the different types of HOST (also called LIS) setup and how each setup affects the processing of results. This information is only given from a user standpoint. Details about special settings or configuration of the HOST connection are located in documents external from this manual.

The MAGLUMI[®] system can be set up to communicate with the Laboratory Information System (LIS) in different configurations.

NOTE

LIS = Laboratory Information System: is a system used for computerized management of labs dedicated to chemical-clinical or microbiological analysis. This is not a feature of the MAGLUMI[®] software. The LIS is an external program used in most clinical institutions for centralized information processing.



The host program is not Part of the MAGLUMI[®] Diagnostic System. Therefore, SNIBE Co., Ltd. cannot guarantee for the safe cooperation of the MAGLUMI[®] software and the host software. There exist no warranty by SNIBE Co., Ltd. Against data safety corruption by the host program.



Configuration changes for the LIS are to be accomplished only by trained authorized personnel for the MAGLUMI[®] system



For maintaining safety of the diagnostic results, it is necessary to accomplish a complete qualification test for the host connection by the user.

16.2 Host Setup in MAGLUMI[®] software

There are several host options in the MAGLUMI[®] software. This section describes the different access possibilities. These definitions will be needed later in this chapter.

16.2.1 ASTM Setup dialog

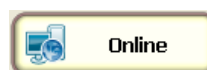
When the MAGLUMI[®] is Host connected, certain settings must be done from the main program, using the ASTM Setup Dialog present in **<System> <Online>** (Fig.16.2-1).

Fig.16.2.1-1: "ASTM Setup Dialog"

Analyzer ID	This field allows assigning a unique Analyzer ID to the MAGLUMI®.
Host ID	This field allows assigning a specific name to the host (required).
COM Port	This field specifies the serial port of the MAGLUMI® PC used for host communication. Host can be connected to any free COM port, except for COM1, which is used for the connection to the Analyzer.
Baud Rate	Specifies the Baud Rate used for transmissions between MAGLUMI® and the host any values from 4800 to 19200 can be chosen. MAGLUMI® and Host have to have matching Baud Rate speeds.
Delimiters	These fields specify the set of delimiters used for transmissions. Modification is not recommended.

16.2.2 Online icons in the MAGLUMI® software

Online icons can be found in the MAGLUMI® software.



Upload <Online> used for sending results from the MAGLUMI® system PC to the LIS (Host).

This icon can be used to upload results in **[Journal]** and **[Valid]**.

16.3 Types of possible Host Connections in MAGLUMI® software

Major types of transmission between the Host and MAGLUMI® are the following:

Host Query	All downloading data transferred from LIS to the MAGLUMI® system PC are accomplished automatically when the samples are loaded.
-------------------	---

In addition to this type of communication, there are many variables that are available. These will be described in user detail in this chapter.

16.3.1 Host Query

When samples are loaded on the MAGLUMI® and after closing the flap or within a certain period of time (approximately <1 minute), the MAGLUMI® automatically sends a query to the Host and the LIS responds with the job list associated to those loaded samples.

Although the Host Query has many types of possible settings, the automatic reception of the job list remains the same.

NOTE

In this configuration it is also possible to request a Query All by pressing the <Online> icon (download) from the [Report].

16.3.1.1 How to accept job lists from the LIS using Host Query

1. Load the barcode-labeled patient samples in accordance with chapter 15.
2. Wait for the job list to appear in the patient sample dialog.
3. Repeat steps 1 and 2 until all patient racks have been loaded.



Patient racks may not be loaded too fast. It must be ensured that the HOST allows enough time to pass between individual requests (timeout) so that the system can be kept in operation. Failure to comply with the above instructions could result in the loss of patient data.

16.3.2 How To send results to the LIS

Once the patient samples have been run and results are present, the user can send results to the Host as follows:

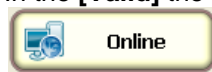
16.3.2.1 Results transmitted with validation on MAGLUMI® as manually sending of results

The results will be validated on the analyzer, and will be sent to the host manually from the **[Valid]**.



In this configuration, the **<Valid>** icon is used in the **[Report]** and all results that have been selected will be transferred to the **[Valid]**. The selected data will be deleted from the **[Journal]**.

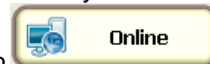
In the **[Valid]** the user must press the **<Online>** icon



(Uploading) to send all results to the Host. The transfer is completed when the status reads **[Finished]**.

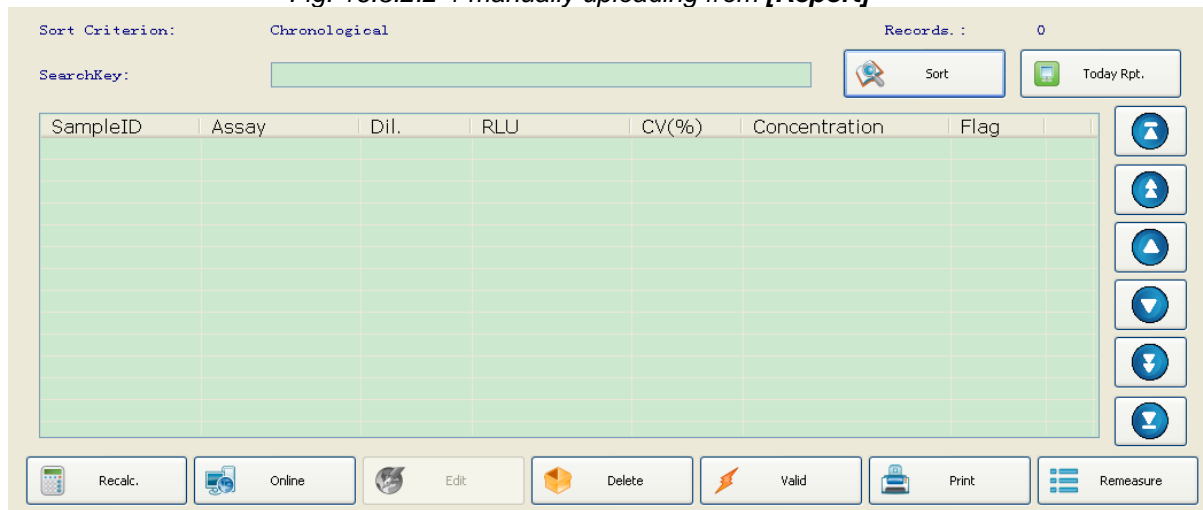
16.3.2.2 Results transmitted without validation on MAGLUMI® as manually sending of results

The results can not be validated on the analyzer but will instead be sent to the host manually for their validations. In this configuration,



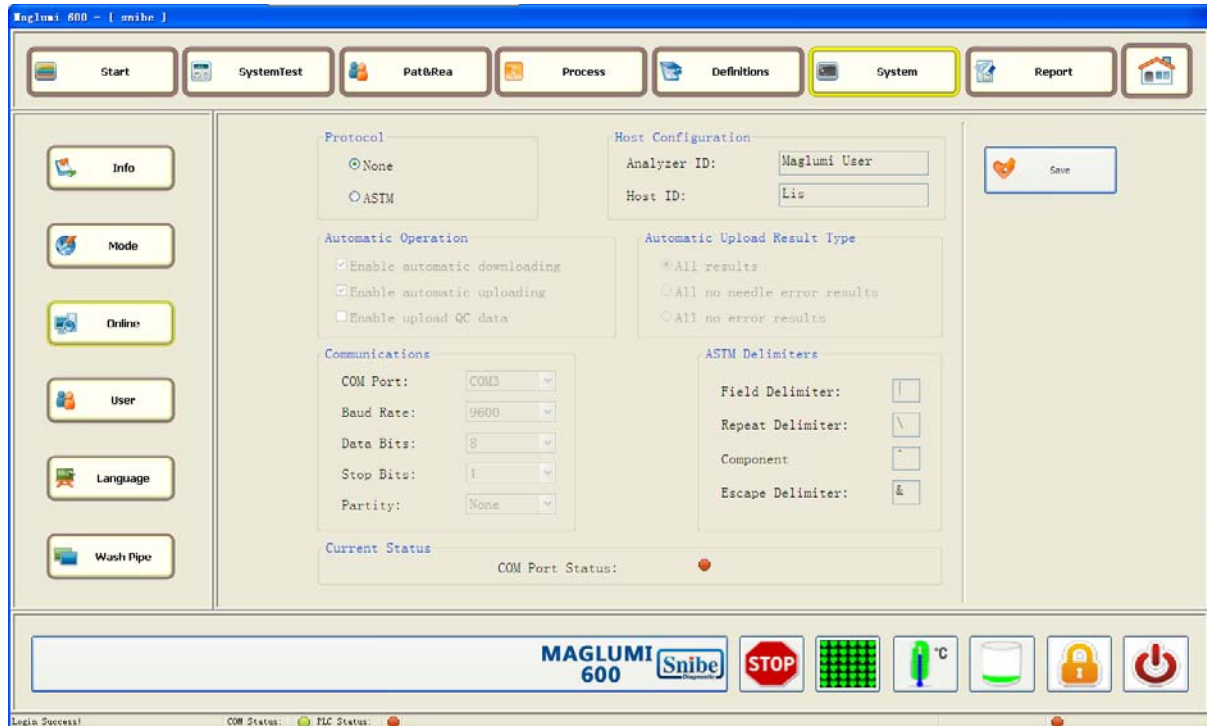
an **<Online>** icon (Uploading) appears in the **[Journal]** (as pictured in *fig. 16.3.2-1 manually uploading from [Report]*).

Fig. 16.3.2.2-1 manually uploading from **[Report]**



16.3.2.3 Results transmitted without validation on MAGLUMI® as an automatic sending of results

The results can not be validated on the analyzer but will instead be sent to the host automatically for their validations.



Click the **Enable automatic uploading** to mark a “✓” on this option to enable automatic uploading test results without validation. If the user enable automatic uploading, there are 3 options for it :

[All results]

automatic uploading all results anyway, including those with flag of machine error, pipetting error, etc.

[All no needle error results]

automatic uploading all results, except those with flag of needle error.

[All no error results]

automatic uploading all results, except those with flag of machine error

Check the results on the Host, if any results are not transmitted correctly, manually transfer them again according to chapter **16.3.3.2**

16.4 MAGLUMI® software communication format

MAGLUMI® software use ASTM E1394 protocol for communication. Directory \online\log records all the communications between the software and LIS.

The content of the communication between MAGLUMI® software and LIS is as following:

16.4.1 Inquiry Reagent Information

Once the sample rack is inserted in to the sample area, after the barcode reader reads the barcode labeled on the sample tube, MAGLUMI® software will inquiry the LIS host for the assay need to be performed for the sample.

Communication content:

```
--><ENQ>
<--<ACK>
--><STX>
<--<ACK>
-->H|\^&||PSWD|Maglumi 600||||Lis||P|E1394-97|20100323<CR>
Q|1|^1234567||ALL||||||O<CR>
L|1|N<CR>
<--<ACK>
--><ETX>
<--<ACK>
--><EOT>
<--<ACK>
```

Symbol meaning:

Letter	means	ASCII
-->	send	
<--	receive	
<ENQ>	enquiry	0x05
<ACK>	answer confirm	0x06
<STX>	text start	0x02
<ETX>	text ends	0x03
<CR>	home	0x0D
<EOT>	transmitting end	0x04

Here:

```
H|\^&||PSWD|Maglumi 600||||Lis||P|E1394-97|20100323<CR>
Q|1|^1234567||ALL||||||O<CR>
L|1|N<CR>
```

This is a message which ASTM E1397 enquiry the assay needs to be performed for the sample. Here we take sample ID 1234567 for example.

16.4.2 LIS return the assay information

```

<--<ENQ>
--><ACK>
<--<STX>
--><ACK>

<--H|\^&||PSWD|Maglumi 600||||Lis||P|E1394-97|20100319<CR>
P|1<CR>
O|1|1234567||^^^CA125|R<CR>
O|2|1234567||^^^CA153|R<CR>
O|3|1234567||^^^CYFRA211|R<CR>
O|4|1234567||^^^FT3|R<CR>
O|5|1234567||^^^FT4|R<CR>
O|6|1234567||^^^T3|R<CR>
O|7|1234567||^^^TG|R<CR>
O|8|1234567||^^^TGA|R<CR>
L|1|N<CR>
--><ACK>
<--<ETX>
--><ACK>
<--<EOT>
--><ACK>

```

Letter meaning as the above

Here:

```

H|\^&||PSWD|Maglumi 600||||Lis||P|E1394-97|20100319<CR>
P|1<CR>
O|1|1234567||^^^CA125|R<CR>
O|2|1234567||^^^CA153|R<CR>
O|3|1234567||^^^CYFRA211|R<CR>
O|4|1234567||^^^FT3|R<CR>
O|5|1234567||^^^FT4|R<CR>
O|6|1234567||^^^T3|R<CR>
O|7|1234567||^^^TG|R<CR>
O|8|1234567||^^^TGA|R<CR>
L|1|N<CR>

```

This is a message which is returned by ASTM E1394 LIS includes the relative assay need to be performed for the sample. Here sample ID 1234567 will be performed assay: CA125, CA153, CYFRA211, FT3, FT4, T3, TG and TGA.

16.4.3 Sending test results

```
--><ENQ>
<--<ACK>
--><STX>
<--<ACK>
-->H|\^&||PSWD|Maglumi 600||||Lis||P|E1394-97|20100326<CR>
P|1<CR>
O|1|1234567|^^^CYFRA211<CR>
R|1|^^^CYFRA211|0|0 to 7|N|||||20100326172956<CR>
L|1|N<CR>
<--<ACK>
--><ETX>
<--<ACK>
--><EOT>
<--<ACK>
```

Letter meaning as above,

Here:

```
H|\^&||PSWD|Maglumi 600||||Lis||P|E1394-97|20100326<CR>
P|1<CR>
O|1|1234567|^^^CYFRA211<CR>
R|1|^^^CYFRA211|0|0 to 7|N|||||20100326172956<CR>
L|1|N<CR>
```

This is a message which ASTM E1394 sending the test results to LIS. Here sample ID 1234567 performed assay CYFRA211 test result is sent to LIS.

Chapter 17

Quality Control

17.1 Quality Control in overview 2

17.1 Quality Control in overview

To comply with statutory requirements, analytical results should be subjected to an internal laboratory and external quality control.

The results of all control values that have been defined in the “Control” section of the MAGLUMI® software (see chapter 7.3) are transferred to the QC software.

[QC] icon


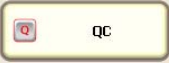
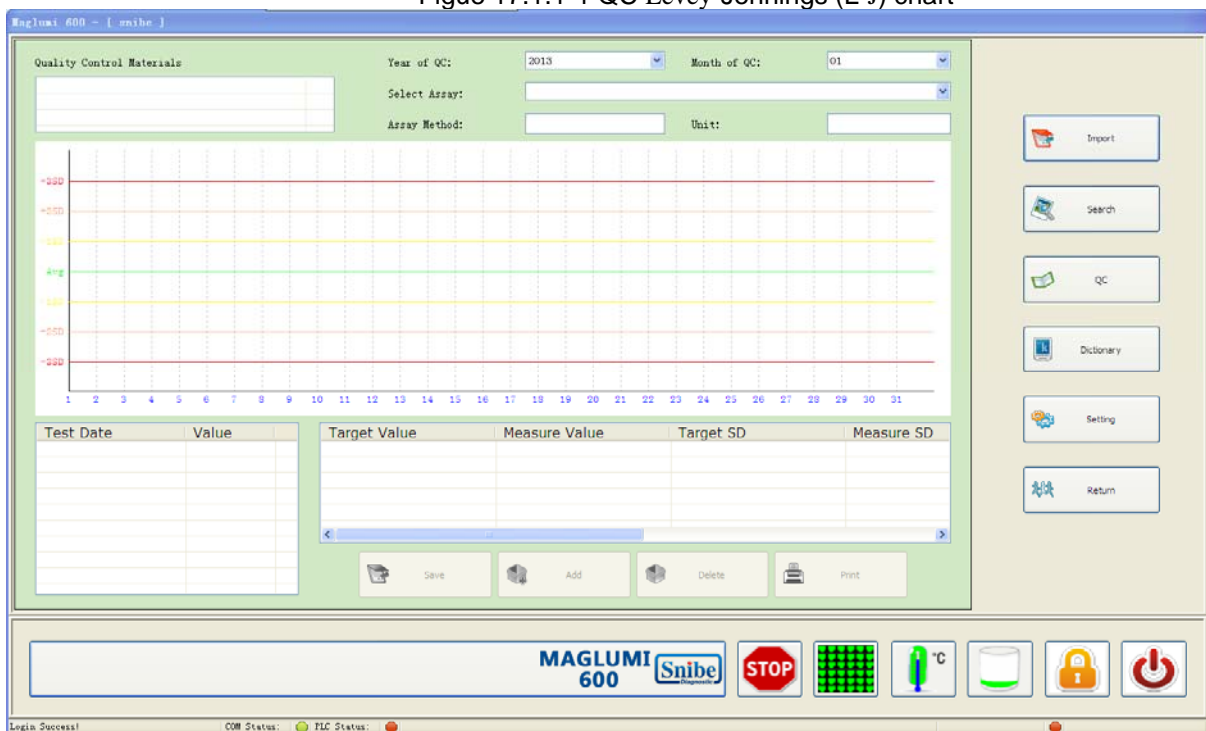
Press the icon  in the main menu, then select sub-function icon  to show the QC Levey-Jennings (L-J) chart for the assay with valid QC results. See the below figure 17.1.1-1.

Figure 17.1.1-1 QC Levey-Jennings (L-J) chart



At the top section of [QC] dialog box:

(Select Assay) check the list for assay selection

(Year of QC) select the year of QC results performed

(Year of Month) select the month of QC results performed

(Quality Control Materials) select the quality control material of QC results, which is allowed for multi-selection, displaying different serial QC data in L-J chart accordingly.

Note : The QC results should be **VALIDATED** in the [Report-Journal] before implementation in the L-J chart.

At the bottom section of [QC] dialog box:

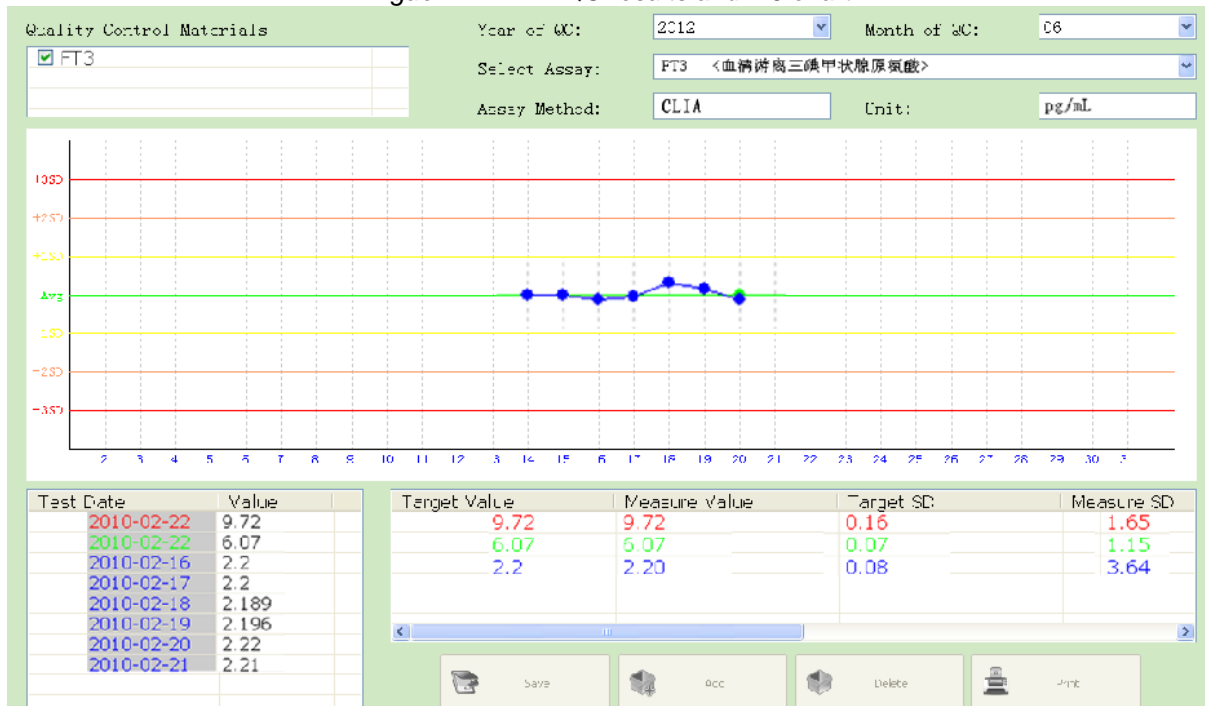
[Save] to save setting after manually input or modify QC data

[Add] manually input or modify QC data

[Delete] delete one result from L-J chart

[Print] to print out the QC results and L-J chart

Figure 17.1.1-2 QC results and L-J chart



Chapter 18

Care and Maintenance

18.1 Care and Maintenance in overview	2
18.2 Daily Maintenance instructions	3
18.3 Weekly Maintenance instructions	4
18.4 Monthly Maintenance instructions	6

18.1 Care and Maintenance in overview

In order to ensure reliable and constant reproducibility, the regular maintenance must be carried out on the MAGLUMI[®] Analyzer.

The MAGLUMI[®] Maintenance instructions are listed in this chapter and are divided into four parts:

1. **Daily maintenance**
2. **Weekly maintenance**
3. **Monthly Maintenance**
4. **Assay Specific**

“Monthly” maintenance already includes “Weekly” and “Daily” maintenances, which are thereby automatically carried out when accomplishing the monthly maintenance. The same rule applies for “Weekly” to “Daily” maintenance.

All instructions should be read through before the analyzer is started.



The complexity of the MAGLUMI[®] Diagnostic System guarantees reliable results but assumes a high knowledge and technical understanding to perform certain service and maintenance actions which are reserved to well trained persons authorized by SNIBE Co., Ltd.

For maintaining safety of the MAGLUMI[®] Diagnostic System, the user is only allowed to accomplish maintenance and service actions as described in this Operating Instruction.

It is necessary to distinguish between daily, weekly and monthly maintenance, which is completed with function testing of the analyzer and then logged in the MAGLUMI[®] maintenance schedule.

You will find a detailed description of the maintenance work at the end of these operating instructions.



Proper protection must be worn at all times while performing maintenance due to chemical/biological hazards.



The used reaction modules and the waste liquids may contain potentially infectious material; therefore, these liquids and the installed MAGLUMI[®] Waste Bags are to be disposed according to the domestic requirements.



Contaminations of the MAGLUMI[®] Diagnostic System can jeopardize diagnostic results. This Operating Instruction contains detailed cleaning instructions and a definition of the cleaning regiment, which is to be followed conscientiously.



For maintaining safety, the MAGLUMI[®] Diagnostic System may only be run with consumables (cuvettes, wash buffer, system liquid, containers and waste bags) approved by SNIBE Co., Ltd.

18.2 Daily Maintenance instructions

The daily maintenance is to be performed as titled, daily. It is recommended to perform the daily maintenance either before or after daily usage.

Also required daily (recommended at the end of the working day) is the saving of the database.

Required equipment:

200 ml commercial hypochloride or bleach
MAGLUMI[®] Wash/System Liquid concentrate

Required time:

It should take a maximum estimated time of 45 minutes for the completion of the daily maintenance.

Preparation:

Wash/System Liquid must be prepared a minimum of 6 hours prior to usage. See chapter 13 for preparation instructions.



Failure to prepare Wash/System Liquid a minimum of 6 hours prior to usage can result in degassing of the system and therefore jeopardize test results.

Procedure:

1. Clean the instrument covers if necessary using a lint-free cloth and normal water.
2. Visually check the condition of the pipettor needles (if any black coating is missing on the needle tip, contact the local service center immediately).
3. Check the position of the needles in accordance with chapter 6.1.5.
4. Empty the waste tank and preferably add 200 ml of commercial hypochloride or bleach.
5. Replace the reaction module waste bag if necessary.
6. Check system liquids
7. Check Starter levels and replace them if not sufficient for a daily work routine (see chapter 13.2.2.2).
8. Check Wash/System Liquid level and if necessary add a solution prepared at least 6 hours prior to use (see chapter 13.2.2.1).
9. Start system test in accordance with chapter 9.

18.3 Weekly Maintenance instructions

The weekly maintenance is to be performed on a weekly basis. Due to the time involved, it is recommended to perform the weekly maintenance at the end of each working week.

Also required daily (recommended at the end of the working day) is the saving of the database (see chapter 4.3.5 for details).

Required equipment:

200 ml commercial hypochloride or bleach
MAGLUMI® Wash/System Liquid concentrate

MAGLUMI® Starter Reagent
Fresh water, defined according to NCCLS guidelines for laboratory water (Type III),
0.5% diluted Hypochloride solution
Lint free cloth

Required time:

It should take a maximum estimated time of 90 minutes for the completion of the weekly maintenance.

Preparation:

Dilute 0.5% active hypochloride to 99.5% of fresh water, defined according to NCCLS guidelines for laboratory water (Type III).

Wash/System Liquid must be prepared a minimum of 6 hours prior to usage. See chapter 13 for preparation instructions.



Failure to prepare Wash/System Liquid a minimum of 6 hours prior to usage can result in degassing of the system and therefore jeopardize test results

Procedure:

1. Switch off the system

- a. Exit the MAGLUMI® software
- b. Close all programs on the PC
- c. Turn off the PC & Monitor
- d. Turn off the analyzer

2. Cleaning the system

- a. Clean external portions of instrument covers with a solution of diluted hypochloride of 0.5%.
- b. Clean the exterior parts of the two needles with a lightly dampened cloth of distilled water, taking great care not to bend the needles.
- c. Visually check the condition of the pipettor needles (if any black coating is missing on the needle tip, contact the local service center immediately).
- d. Clean the touch screen monitor with a lightly dampened cloth of distilled water & wipe dry with a clean dry lint free cloth.

- e. Empty the waste tank and preferably add 200 ml of commercial hypochlorite or bleach.
 - f. Replace the reaction module waste bag if necessary
- 3. Check system liquids**
 - a. Check Starter levels and replace them if not sufficient. (see chapter 13.2.2.2).
 - b. Check Wash/System Liquid level and if necessary add a solution prepared at least 6 hours prior to use (see chapter 13.2.2.1).
 - 4. Switch on the system**
 - a. Switch on the PC system in accordance with chapter 4.2.
 - b. Start the MAGLUMI[®] software & system in accordance with chapter 4.
 - c. Check the position of the needles in accordance with chapter 6.1.5.
 - 5. Pre-prime the system using the tables listed below and according to chapter 9, if system liquids were replaced.**

Fig 18.3-1: Pre-priming table for replacing system Liquid

Section	Type	Values
Cycles	Pipettor	10
	Washer	10
	Chamber Set A	0
Reaction modules	BGW	0
	LC - le	0
	LC - ri	0

Fig 18.3-2: Pre-priming table for replacing starter reagent

Section	Type	Values
Cycles	Pipettor	0
	Washer	0
	Chamber Set A	10
Reaction modules	BGW	0
	LC - le	0

If both liquid supplies were replaced, the values in the tables above must be combined.

- 6. Start system test in accordance with chapter 9.**

18.4 Monthly Maintenance instructions

The monthly maintenance is to be performed on a monthly basis. Due to the time involved, the monthly maintenance should be performed at regular intervals according to the working habits of the customer. Also required daily (recommended at the end of the working day) is the saving of the database (see chapter 4.3.5 for details).

Required equipment:

200 ml commercial hypochloride or bleach
MAGLUMI® Wash/System Liquid concentrate
MAGLUMI® Starter Reagent
MAGLUMI® System tubing cleaning solution
Fresh water, defined according to NCCLS guidelines for laboratory water (Type III),
1 system liquid container with 0.5% diluted active Hypochloride solution **Example:** a 7% solution of active chlorine must be diluted 1:14 with distilled water (circa 70 ml/ 1000 ml).
1 system liquid container with water (water quality must be according to NCCLS guidelines for laboratory water (Type III)
Lint free cloth
2 empty starter reagent containers
Alcohol

Preparation:

Wash/System Liquid must be prepared a minimum of 6 hours prior to usage. See chapter 13 for preparation instructions.



Failure to prepare Wash/System Liquid a minimum of 6 hours prior to usage can result in degassing of the system and therefore jeopardize test results

Procedure:

- 1. Switch off the system**
 - a. Exit the MAGLUMI® software
 - b. Close all programs on the PC
 - c. Turn off the PC & Monitor
 - d. Turn off the analyzer

- 2. Cleaning the system**
 - a. Clean external portions of instrument covers with a solution of diluted hypochloride of 0.5%.
 - b. Clean the exterior parts of the two needles with a cloth damped with **alcohol**, taking great care not to bend the needles.
 - c. Visually check the condition of the pipettor needles (if any black coating is missing on the needle tip, contact the local service center immediately).
 - d. Clean the touch screen monitor with a lightly damped cloth of distilled water & wipe dry with a clean dry lint free cloth.
 - e. Empty the waste tank and preferably add 200 mL of commercial hypochlorite or bleach.

f. Replace the reaction module waste bag if necessary.

3. Switch on the system

- a. Switch on the PC system in accordance with chapter 4.2.
- b. Start the MAGLUMI[®] software & system in accordance with chapter 4.
- c. Check the position of the needles in accordance with chapter 6.1.5.

4. Decontamination and fluidic cleaning

- a. Rinse and fill two empty starter reagent containers with distilled H₂O, preferably at 35° - 40°C.
- b. Replace the starters with the two bottles of distilled H₂O.
- c. Replace the Wash/System Liquid tank with a hypochlorite solution as listed under required equipment.
- d. Execute "System Test" selecting the values at least equal to the following (see 18.4-1):

Fig. 18.4-1: Decontamination Priming Table

Section	Type	Values
Cycles	Pipettor	10
	Washer	10
	Chamber Set A	10
Reaction modules	BGW	0
	LC - le	0

e. Replace the hypochlorite solution system liquid tank with another system liquid tank containing distilled H₂O.

4. Perform the System tubing cleaning procedure

- a. Prepare the kit integral with Maglumi System tubing cleaning solution
- b. Insert the cleaning kit to the analyzer and run the <Wash Pipe > function in the User software.(refer to Chapter 6.6)

Chapter 19

System Warnings and Messages

- 19.1 System warnings and messages in overview----- 2
 - 19.1.1 <Message Box > dialog, <OK> in detail ----- 3
 - 19.1.2 <Message Box > dialog, <View> in detail----- 4
 - 19.1.3 <Message Box > dialog, <Print> in detail----- 5
 - 19.1.4 <Message Box > dialog, <Delete> in detail ----- 6
 - 19.1.5 <Message Box > dialog, <Sort> in detail ----- 8
- 19.2 Emergency stop of the analyzer----- 9
- 19.3 Messages, problems, and corrective action on the MAGLUMI® Analyzer ----- 12
 - 19.3.1 Common problems, and corrective action on the MAGLUMI® Analyzer----- 12
 - 19.3.2 “System Test” <BGW> Troubleshooting on the MAGLUMI® Analyzer ----- 13
 - 19.3.3 “System Test” <LC> Troubleshooting on the MAGLUMI® Analyzer ----- 14
 - 19.3.4 Sample result Troubleshooting on the MAGLUMI® Analyzer----- 16
 - 19.3.5 Common Error messages and solutions on the MAGLUMI® Analyzer ----- 17
- 19.4 Error messages and recovery action ----- 18

19.1 System warnings and messages in overview

The software manages all system and error messages in a list, which is stored in the system database. With this list the service technician and the interested user are given the possibility, to obtain a general survey of all system messages during a certain period. This narrows the possibilities of conclusions of Error occurrences and their removal.

The actual system and error messages are shown in the lower left hand corner of the main menu. A **[Message Box]** can be obtained by a click in this dialog box.

Fig. 19.1-1: Access to Dialog box **[Message Box]**

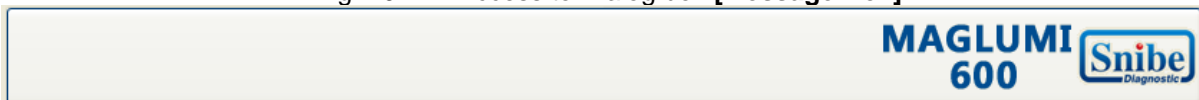
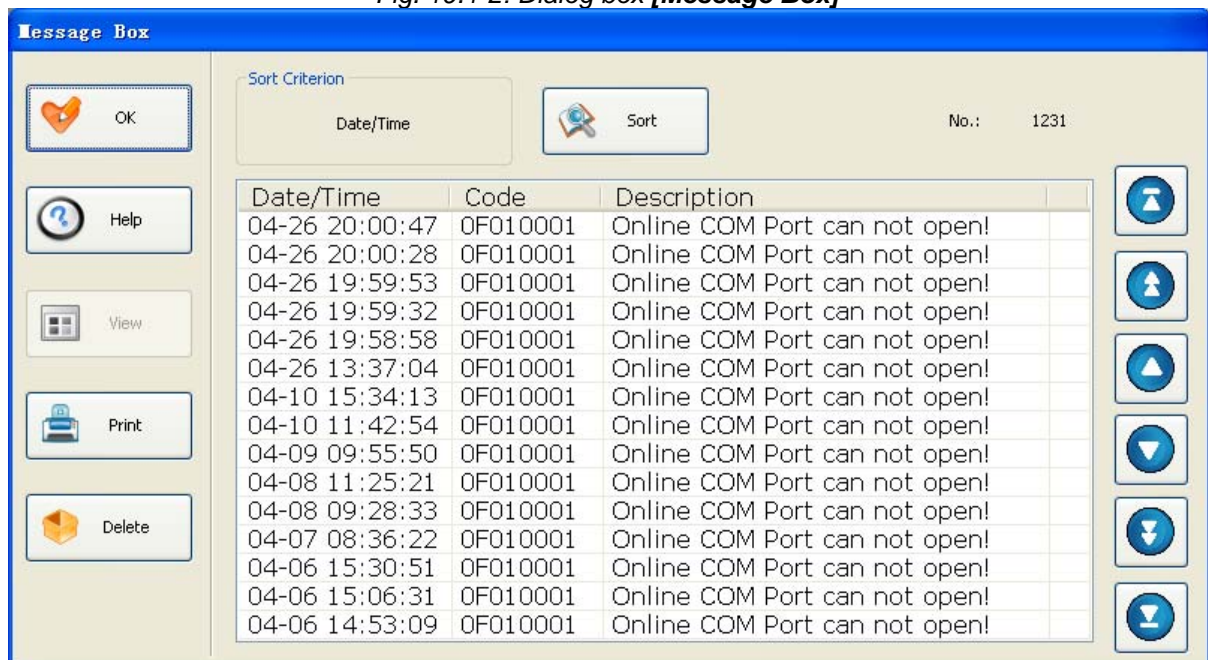
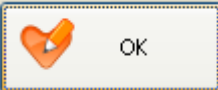



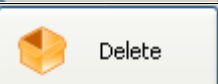
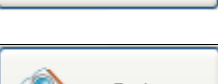
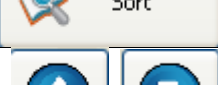



Fig. 19.1-2: Dialog box **[Message Box]**



All system and error messages will be listed in this dialog box. The messages are in a list format in which each entry contains one message.

	Pressing this icon exits this dialog and returns to the main menu.	19.1.2 <Message Box> dialog, <OK> in detail
	This function is not implemented.	
	When pressing this button, the user can view the details of the system message.	19.1.3 <Message Box> dialog <View> in detail
	This icon is used for printing system messages.	19.1.4 <Message Box > dialog <Print> in detail
	This icon is used for deleting a selected system message from the databank of the MAGLUMI® software.	19.1.5 <Message Box > dialog <Delete> in detail
	This icon is an access button to enter the desired sorting classification.	19.1.6 <Message Box > dialog <Sort> in detail
	By using the arrows, the user can move page by page in search of a message.	
	By using the arrows, the user can move item by item in search of a message.	

[No.: x] Amount of total system and error messages in the list.
 For example: [No.: 1230] in Fig. 19.1-1 means the list contains 1230 messages in total.

Each entry contains the following information (from left to right):

04-12 10:33:16	0F010001	Online COM Port can not open!		
04-10 15:38:13	0F010001	Online COM Port can not open!		

[Date/Time] Date and time of the occurring message.

[Code] Error code

[Description] Description of the message.

19.1.1 <Message Box > dialog, <OK> in detail



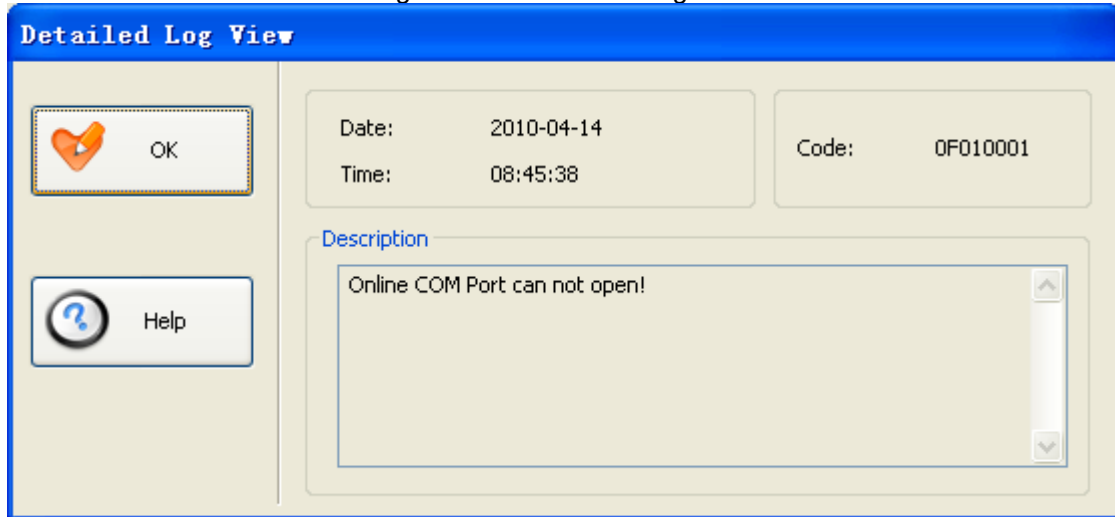
Pressing the icon from the **<Message Box >** dialog exits the dialog and returns to the main menu dialog. This icon serves only as an exit button.

19.1.2 <Message Box > dialog, <View> in detail



The icon allows the user to view the details of the selected message in the <Message Box >. The "Detailed Log View" dialog will open when this icon is pressed. (See Fig. 19.3.1-1: Detailed Log View)

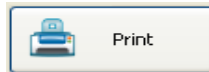
Fig. 19.1.2-1: Detailed Log View



This dialog box is closed by clicking <OK> and returns automatically to the dialog box [Message Box].

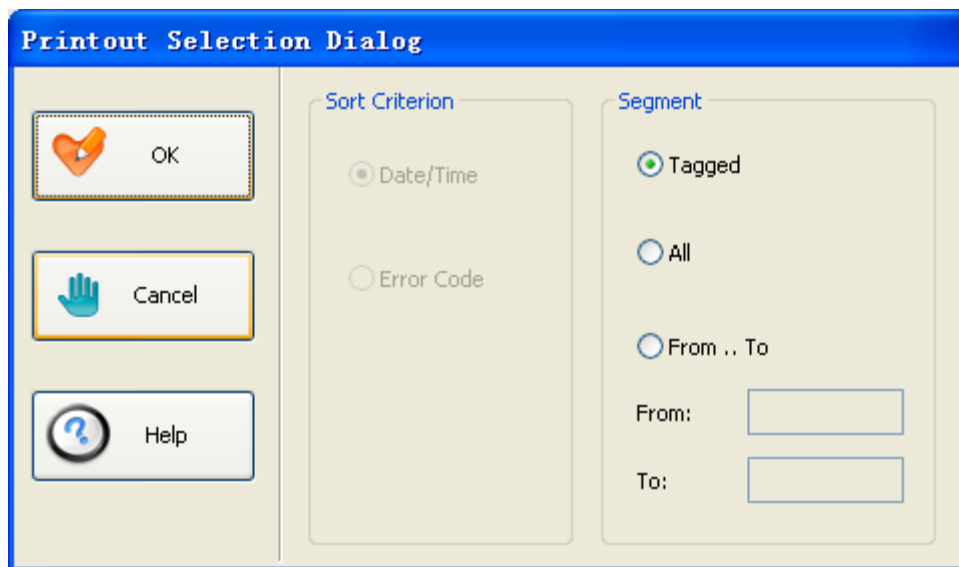
19.1.3 <Message Box > dialog, <Print> in detail

The “**Printout Selection Dialog**” is accessed by pressing the icon



. In the “Printout Selection Dialog”, the user has the choice of which system and / or error messages can be selected and printed.

Fig. 19.1.3-1: Printout Selection Dialog



This dialog box is user restricted and is open only to the “**Segment**” section.

The user may select one of three options here:

Tagged
All
From...To

Tagged

System and error messages are marked by “tagging” and can be printed as such. The “tagging” is accomplished by selecting an item in the dialog box [**Message Box**] per mouse click, and then pressing the key “**F7**”. The “tagging” can also be erased by pressing the “**F7**” again.

Messages that are “tagged” are identified with the symbols “ * ” found at the end of the selected entry.

All

When the selection “All” is selected, the complete message list will be printed.

From...To

When the selection “From...To” is selected the user must then enter the error codes from the wanted beginning to the last error code wanted.

The selection “From...To” is only functional when the sort criteria are set by “Error Code” & “Ascending”. See section 19.1.6.

Pressing the “OK” icon confirms the selection and starts the printing.
Pressing the “Cancel” icon exits the dialog without printing.

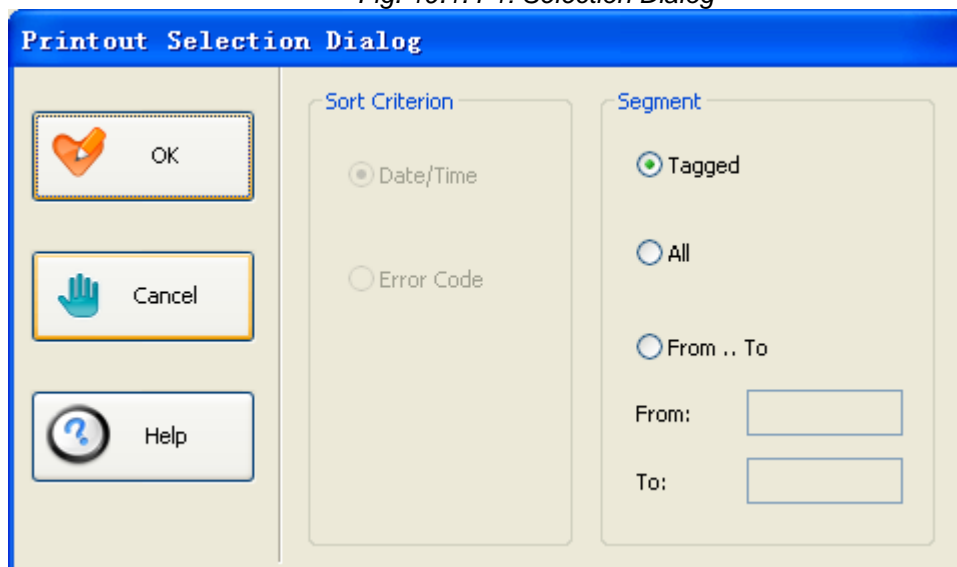
19.1.4 <Message Box > dialog, <Delete> in detail



The “**Selection Dialog**” is accessed by pressing the icon.

One can define in the section “Segment” which messages should be deleted. This area corresponds to that of the dialog box [Printout Selection Dialog].

Fig. 19.1.4-1: Selection Dialog



This dialog box is user restricted and is open only to the “**Segment**” section.

The user may select one of three options here:

Tagged
All
From...To

Tagged

System and error messages are marked by “tagging” and can be deleted as such. The “tagging” is accomplished by selecting an item

in the dialog box [**Message Box**] per mouse click, and then pressing the key “F7”. The “tagging” can also be erased by pressing the “F7” again.

Messages that are “tagged” are identified with the symbols “» / «” found at the beginning and the end of the selected entry

All

When the selection “All” is selected, the complete message list will be deleted.

From...To

When the selection "From...To" is selected the user must then enter the error codes from the wanted beginning to the last error code wanted.

The selection "From...To" is only functional when the sort criteria are set by "Error Code" & "Ascending". See section 19.1.6.

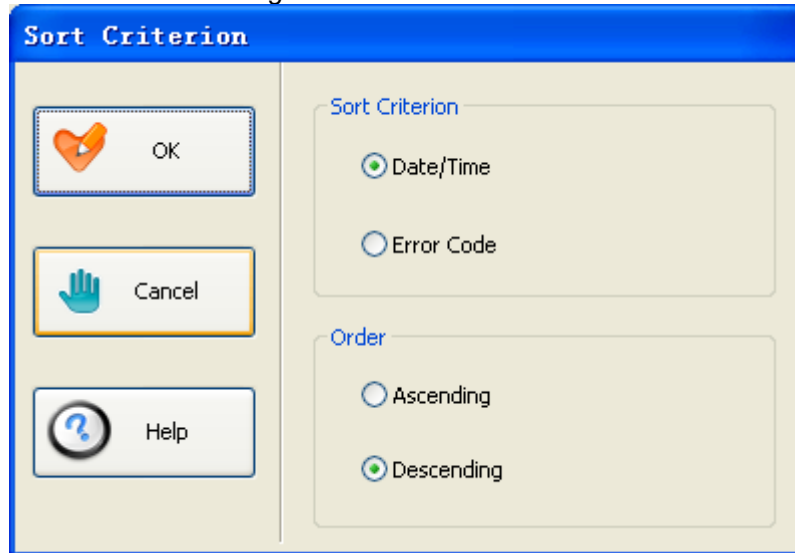
Pressing the "**OK**" icon confirms the selection and executes deletion. Pressing the "**Cancel**" icon exits the dialog without deleting any items.

19.1.5 <Message Box > dialog, <Sort> in detail



The icon allows the user to arrange the order of the complete messages in the <Message Box>. The “Sort Criterion” dialog will open when this icon is pressed. (See Fig. 19.1.6-1: Sort Criterion)

Fig. 19.1.5-1: Sort Criterion



<OK> Exits the dialog and accepts the changes made

<Cancel> Exits the dialog without accepting any changes

Sort Criterion:

Date/Time Date and time of the occurring message.

Error Code Sorts the message box according to message error code

Order:

Ascending arranges the chosen “Sort Criterion” by placing the earliest message box entries numerically from top to bottom (date or error code)

Descending arranges the chosen “Sort Criterion” by placing the earliest message box entries numerically from bottom to top (date or error code)

19.2 Emergency stop of the analyzer

An emergency stop of the analyzer may be accomplished in two ways:

Automatic **The system stops a run due to a mechanical error.**

- After the occurrence of a mechanical error, the analyzer is automatically stopped in its momentary activity and indicates an error message on the screen. This informs the user which error and at which component in the analyzer this error has occurred to produce an emergency stop.

Manual **The user stops the run to prevent or to stop an occurring error.**

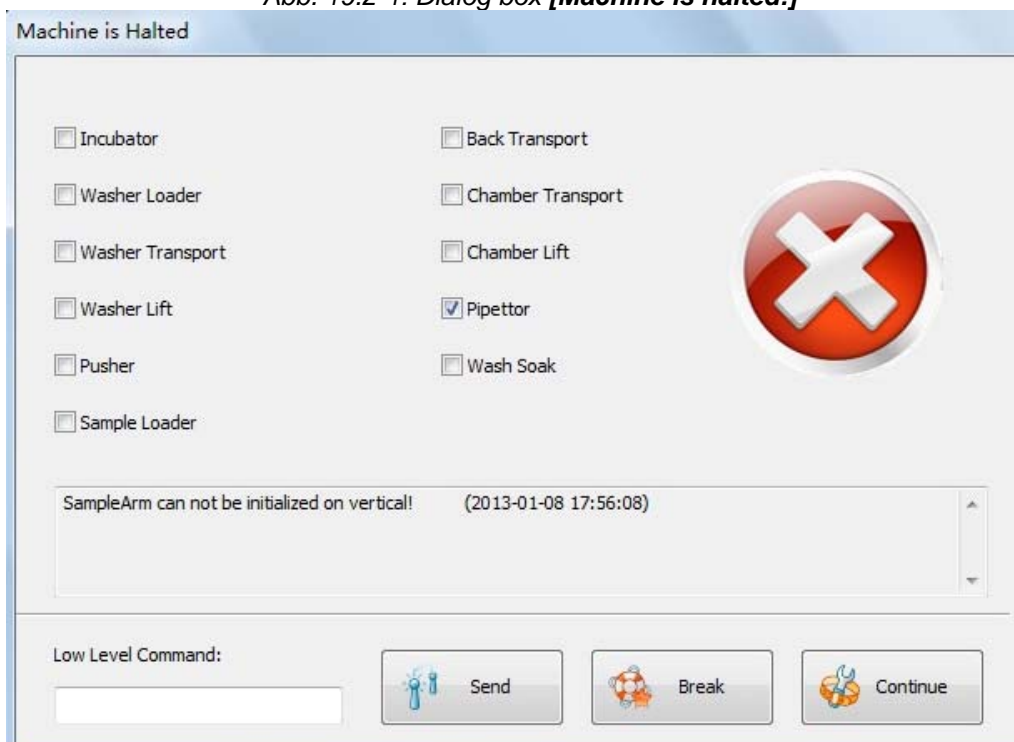
- The user has noticed a mistake, or improper handling, or a life-threatening situation has or is about to occur and has pressed the **[STOP]** button located in the bottom task bar of the software.



Both situations are handled in the same manner except when stopping the analyzer manually, an error message will not appear, the software will show the **[Machine is Halted]** dialog.

After confirming an error message with **<OK>** (automatic stop only) another dialog box opens **[Machine is halted!]**.

Abb. 19.2-1: Dialog box **[Machine is halted!]**



[Sample Loader]	initializes the pronged pusher to transport the reaction modules from incubator to the Washer
[Incubator]	initializes the incubator
[Washer Loader]	initializes the rod to transport the reaction module from the incubator into the washer channel.
[Washer Transport]	initializes the toothed rod for transporting the reaction modules through the washer channel.
[Washer Lift]	initializes the washer sub-component with injection and suction needles for washing the reaction modules with system liquid.
[Pusher]	initializes the component used to transport the reaction modules in the back transport channel (Two-step-Assay) or into the measure chamber.
[Back Transport]	initializes the pronged pusher used to transport the reaction modules in the right Pipetting position and incubator (Two step-Assay).
[Chamber Transport]	initializes the gears for transporting the reaction modules into the measure chamber.
[Chamber Lift]	initializes the measuring chamber sub-component with injection and suction needles for the starter reagent in the measure chamber.
[Pipettor]	initializes the pipettor system
[Low Level Command]	field for entering predefined commands for controlling the individual components. Only to be used by service technicians.
[Send]	icon used for initializing one of the chosen components listed above. The chosen component is displayed with a check (✓) (Multiple choices are possible but only one component will be initialized at a time).
[Break]	when this icon is pressed, all functions of the analyzer will be interrupted. An initialization and clearing of the system will start.
[Continue]	icon for continuing analyzer operations after an error message has appeared.

NOTE

Before pressing **<Continue>**, it is important that the pipettor is always initialized. Mark the pipettor and press **[Send]**, afterwards press **[Continue]**.

How to:

1. An error has occurred on the analyzer and a message is shown.
2. Refer to the troubleshooting table for the error code and its solution.
3. Press **"OK"** to confirm the acknowledgement of the error.
4. Follow the suggestions listed in the troubleshooting table.
5. Check the assembly to initialize.
6. Press **"Send"**
7. Repeat steps 5 & 6 if necessary.
8. Check the **"Pipettor"** assembly.
9. Press **"Send"**
10. Press **"Continue"**



Active tests that were currently in progress on the analyzer at the time of a [Break] will be discarded and reset in the daily lab-journal in the status [placed].!



If the red [STOP] button is pressed in the main menu, the dialog box [EMERGENCY STOP] is opened. Which (after confirming the safety request with <Yes>) leads to an operation halt on the analyzer and automatically the dialog box [Machine is halted] will be opened.

CAUTION

Before pressing <Continue>, it is important that the pipettor is initialized. Mark the pipettor and press [Send], afterwards press [Continue].

19.3 Messages, problems, and corrective action on the MAGLUMI® Analyzer

The following items are listed to help the user apply simple troubleshooting procedures on the MAGLUMI® system.

19.3.1 Common problems, and corrective action on the MAGLUMI® Analyzer

Problem: “No connection to device”

Situation 1:

The analyzer has been switched on and the message appears.

Resolution 1:

Press the “Enter” key on the keyboard or select the “OK” icon. This is a normal message when first starting the analyzer.

Situation 2:

The analyzer is in initialization/operation and the message appears but no power shortage has occurred.

Resolution 2:

Press the “Enter” key on the keyboard or select the “OK” icon.

If tests are currently being run, the analyzer will continue without any interruption.

If an initialization was in progress, the analyzer will restart the initialization.

Situation 3:

The analyzer is in initialization/operation and the message appears continuously but no power shortage has occurred.

Resolution 3:

Contact Service support immediately. A connection problem between PC and analyzer exists.

Problem: “Flooding” during system priming

Situation 1:

The analyzer priming has been started and a “Chamber Flooding” or “Washer Flooding” message appears.

Resolution 1:

Press the “Enter” key on the keyboard or select the “OK” icon to confirm that the message has been seen and wait until the end of the priming to resolve the problem. The element that produced the flooding will not continue to prime but the problem must be resolved before normal operations can continue.

Problem: “System Test not Possible While Machine is active”

Situation 1:

The “system test” icon has been pressed during a run and the above message appears.

Resolution 1:

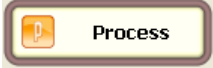
Press the “Enter” key on the keyboard or select the “OK” icon to confirm that the message has been seen and wait until the end of the run. To start a priming or system test.

Situation 2:

The “system test” icon has been pressed while the analyzer is inactive and the above message appears. Sometimes the analyzer switches from inactive to active for no apparent reason. This does not however affect the functionality of the analyzer.

Resolution 2:

Press the “**Enter**” key on the keyboard or select the “**OK**” icon to confirm that the message has

been seen. Press the icon  “**Process**” and then press the “**Init**”



icon. Wait until the end of the initialization and afterwards priming can be started.

19.3.2 “System Test” <BGW> Troubleshooting on the MAGLUMI® Analyzer

The system test troubleshooting is to help the user determine the possible problems and resolutions for analyzers whose results fall outside of the given specifications.

Background Problems:

The purpose of the BGW is to test the functionality of the washer and the low limit of the measurement chamber. When troubleshooting the BGW, the washer must always be checked first. Normally when the measurement chamber has a problem, the error will be observed in both the BGW & LC’s. If the background results should fall outside of the specifications of:

200-1200 RLU’s and <10% CV’s (mean)

Referring to the table below; it is important to troubleshoot the steps in the numerical order listed.

Problem area	Possible problems	Reasons	Solutions
General	1.First value of a run always low (200-1200 RLU’s)	No chamber priming accomplished after analyzer power on or initialization Starter pump leakage	Always prime the system liquids after turning on analyzer power. If the system has not been turned off but the problem still exist contact local technical support for starter pump problems.

Problem area	Possible problems	Reasons	Solutions
Washer	1.Blocked needles	Clogged washer needles due to heavy usage of the analyzer	Cleaning the needles manually and afterwards restart the system test.
	2.Fresh or old Wash/System liquid	Bad washer buffer or gases in the washer buffer	Refer to the IFU for “MAGLUMI® Wash/System liquid” for proper handling procedures and lifecycle of system liquids.
	3.Aspiration tubes worn	Poor suction speed of the washer needles	If points 1 & 2 are ok, contact local technical support.
	4.Washer lift out of adjustment	Washer lift may not be adjusted properly	If points 1 & 2 are ok, contact local technical support.

Problem area	Possible problems	Reasons	Solutions
Meas. chamber	1. Starter 1 & starter 2 reagents are in the wrong positions. (Low RLU values [200-1200])	IFU procedures not followed correctly	Exchange starter reagent bottles 1 & 2 and prime the chamber set A according to chapter 18 "fig. 18.4-1 Decontamination Priming Table"
	2. Defective or dirty starter reagent pumps	Broken part or insufficient maintenance	Clear the pumps according to technical suggestions
	3. Foreign light entering the measurement chamber (causing High CV's)	Measurement chamber cover broken or not installed properly	Contact local technical support
	4. Defective PMT/Blue LED	Possible system flooding	Contact local technical support

19.3.3 "System Test" <LC> Troubleshooting on the MAGLUMI® Analyzer

The system test troubleshooting is to help the user determine the possible problems and resolutions for analyzers whose results fall outside of the given specifications.

Light check Problems:

The purpose of the LC-le is to test the precision of the left pipetting needle and the functionality of the measurement chamber in a normal working range.

When troubleshooting the LC, the Wash/System liquid must always be checked first. Normally when the measurement chamber has a problem, the error will be observed in both the BGW & LC.

If the light check results should fall outside of the specifications of:

400000-650000 RLU's and < 3% CV's (mean)

Referring to the table below; it is important to troubleshoot the steps in the numerical order listed.

Problem area	Possible problems	Reasons	Solutions
Pipetting system	1. Blocked or dirty pipettor needles	Clogged pipettor needles due to heavy usage of the analyzer.	Cleaning the needles manually and afterwards restart the system test.
	2. Fresh Wash/System liquid	Gases in the system liquid causing air bubbles in the tubing therefore creating imprecise pipetting	Refer to the IFU for "MAGLUMI® Wash/System liquid" for proper handling procedures and lifecycle of system liquids.
	3. Defective 2-way valves	Poor performance of a possible old valve	If points 1 & 2 are ok, contact technical support.
	4. Defective diluter syringes	Poor performance of a possible old or worn syringe (i.e. scratched inner space, crystallization build-up)	If points 1 & 2 are ok, contact technical support.

Problem area	Possible problems	Reasons	Solutions
Meas. chamber	1. Starter 1 & starter 2 reagents are in the wrong positions. (Low RLU values [200-1200])	FU procedures not followed correctly	Exchange starter reagent bottles 1 & 2 (see IFU) and prime the chamber set A according to chapter 18 "fig. 18.4-1 Decontamination Priming Table"
	2. Defective or dirty starter reagent pumps	Broken part or insufficient maintenance	Clear the pumps according to technical suggestions
	3. Improper injection of the starter reagent (causing High CV's)	Crystallization build-up of reagent in the measure chamber	Clear the measure chamber according to technical suggestions.
	4. Foreign light entering the measurement chamber (causing High CV's)	Measurement chamber cover broken or not installed properly	Contact local technical support
	5. Defective PMT/Blue LED	Possible system flooding	Contact local technical support

19.3.4 Sample result Troubleshooting on the MAGLUMI® Analyzer

Problem area	Possible problems	Reasons	Solutions
High CV values	1. Serum or reagents contain froth or particulates	Incorrect handling	Visual inspection & eliminate froth or wait until froth has subsided
	2. Wrong type of Patient sample tube has been inserted into the rack and therefore the needle touches the vial wall	Incorrect handling	Place correct sample tubes into the rack. (See Chapter 3.2.1)
	3. Leaks in pipettor tubing system	Visual inspection of pipettor tubes during operation, check system liquid container for availability of fluids, check pipettor needles during washing to ensure that no froth is present and no droplets are on the needles after washing	<ol style="list-style-type: none"> 1. Check valves and fittings for evidence of leakage. 2. Change system liquid if empty. 3. Check needle positions to ensure proper washing. 4. Prime the system.
	5. Particles/Air in system liquids	Foam or gassing in system tubing due to insufficient liquid or fresh liquid.	<ol style="list-style-type: none"> 1. Check reaction modules for bubbles after wash aspiration 2. Check syringes during operation for air bubbles 3. When system liquid has not set at least 6 hours prior to usage this can result in gassing in the pipettor system as well as the wash system of the analyzer.
	4. Defective diluter syringe	Call for help	
	5. Damaged pipette needle tip	Droplets on pipette tips, visual inspection	Call local technical support to replace pipetting needle

Problem area	Possible problems	Reasons	Solutions
High carry over	1. Damaged or dirty pipette needle tips	High CV in light check, droplets on pipette needle tips	After a positive visual inspection, call local technical support to replace pipetting needles
	2. Insufficient pipettor washing		<ol style="list-style-type: none"> 1. Check pipettor coordinates at the wash station. 2. Retrain needle positions to ensure proper washing (see chapter 6 section 6.1.5)
	3. Insufficient aspiration of wash needles	Poor suction speed of the washer needles	<ol style="list-style-type: none"> 1. Visual inspection of wash needles during operation (if possible) that all liquid is aspirated before the reaction module moves to the next position, 2. Check system liquid container for availability of fluids 3. Perform User maintenance (Daily, Weekly, or Monthly; which ever may pertain) 4. Notify local technical support

Problem	Possible causes	Symptoms	Solutions
No rinsing	Rinsing pump failed	No rinsing. No pump sounds	Call local technical support for assistance
High CV, low values	Bad liquid level detection Serum or reagents contain froth or particulates	Visual inspection	Eliminate froth or wait until froth has subsided If no froth is present call local technical support for assistance
Low RLU values on first result of a run	First value of a run always low (300-600 RLU's)	Starter pump system leakage	Check for low starter or air in the starter lines and contact local technical support for starter pump problems
Washer flooding	Washer aspiration pump problems Clogged needles Back transport missed a step when transporting cuvettes Aspiration tubes worn.	Visual inspection	Call local technical support for assistance

19.3.5 Common Error messages and solutions on the MAGLUMI® Analyzer

Error	Solution
Open loop in motor control	Mechanical block of the pipettor arms. Confirm with "OK" --> Mark the pipettor --> "SEND" --> "CONTINUE" (See process on page 19-10)
No cuvette available	<u>Check:</u> Are there 3 cuvettes in the back of the stacker? If yes ==> "MARK" the stacker and "SEND". After the stacker initialization has finished, "MARK" the cuv. loader => "SEND" => PIPETTOR => "SEND" => "CONTINUE".
No cuvette transported	<u>Check:</u> Are there 2 cuvettes in the inc. loader or has a cuvette "fallen down". The inc. loader remains with the tip in the incubator. Solution: "MARK" the inc. loader => "SEND" 2 times => PIPETTOR => "SEND" => "CONTINUE".(See process on page 19-10)
"System-test" not possible. Message: " Machine is active" even though the status is "finished"	From the main menu press the icon " Process " Under the [Process Functions] press the icon " Init " Answer " YES " to the next dialog After the initialization has finished, enter the " System Test " dialog
Flooding washer during system-test	Control of the washer tubes: Do they aspirate during the wash cycles? The left (straight) needle aspirates the serum, (check for needle blockage!!!).
No barcode beam	From the main menu press the icon " Process " Under the [Process Functions] press the icon " LOW LEVEL COMMAND " Type: " 2A 48 " (2A space 48) Press " SEND " Press " OK "
Integral still in use	The integral was removed; even though the analyzer is still using it. Reinsert the integral, it will appear as " Error ", but the pipettor will continue to aspirate from this integral. After all assays are finished and results are posted in the daily journal, remove the integral and reinsert it. It will then appear correctly with the proper number of remaining tests.

19.4 Error messages and recovery action

Sample Loader				
Message number	Message text	Description	Reasons	Recovery action
0131401	Sample Loader forward move not possible"	The Sample Loader is no able to move forward to the incubator or has made forward move and cannot complete its full movement.	A mechanical error prevents the Sample Loader from moving , or the Sample Loader has not been properly adjusted, or the sensor of the Sample Loader doesn't work	1. Mark " Sample Loader " in the [Machine is Halted!] dialog box then press [Send] and afterwards [Continue]. 2. If the problem recurring, technical engineer should be called to check the mechanical parts and sensor
010302	Sample Loader backward move not possible"	The Sample Loader is not able to move back to its initial position.	A mechanical error prevents the Sample Loader from moving , or the sensor of the Sample Loader doesn't work	1. Mark " Sample Loader " in the [Machine is Halted!] dialog box then press [Send] and afterwards [Continue] 2. If the problem recurring, technical engineer should be called to check the mechanical parts and sensor
010303	Sample Loader not initialized"	The Sample Loader has not moved to its initial position	A mechanical error prevents the Sample Loader from moving , or the sensor of the Sample Loader doesn't work	1. Mark " Sample Loader " in the [Machine is Halted!] dialog box then press [Send] and afterwards [Continue] 2. If the problem recurring, technical engineer should be called to check the mechanical parts and sensor

Washer Loader				
Message number	Message text	Description	Reasons	Recovery action
031301	Washer loader forward move not possible	The washer loader is not able to move forward or has moved forward and cannot complete its full movement	Either a mechanical error prevents the washer loader from moving, or the washer loader has not been properly adjusted.	1. Remove the main cover and visually check for obstructions i.e. incubator in a false position, extended washer loader rod (not able to find its limit switch), false adjustments. 2. Remove the washer loader rod and clean the rod holes with a small piece of wire, or compressed air.
031302	Washer loader backward move not possible	The washer loader is not able to move backward or has moved backward and cannot complete its full movement	Either a mechanical error prevents the washer loader from moving or the washer loader cannot find its init/limit hole.	1. Remove the main cover and visually check for obstructions i.e. incubator in a false position, extended washer loader rod (not able to find its limit switch), false adjustments. 2. Remove the washer loader rod and clean the rod holes with a small piece of wire, or compressed air.
031303	Washer loader not initialized	The washer loader has not moved to its initial position	This subassembly was most likely moved manually and must be initialized before starting analyzer functions	1. Manually move the rod to ensure that the washer loader can be easily moved. 2. Mark "washer loader" in the [Machine is Halted!] dialog box then press [Send] and afterwards [Continue] .

Incubator				
Message number	Message text	Description	Reasons	Recovery action
031102	Incubator regulation front	The incubator has not made the required movements in the predetermined time. (System cycles)	Incubator forward movements are too slow	1. Clean the guide tracks with alcohol and a clean cloth. Afterwards lubricate the guide tracks with a very light coat of Vaseline. 2. Adjust the belt and positions
031103	Incubator regulation back	The incubator has not made the required movements in the predetermined time. (System cycles)	Incubator backward movements are too slow	1. Clean the guide tracks with alcohol and a clean cloth. Afterwards lubricate the guide tracks with a very light coat of Vaseline. 2. Adjust the belt and positions
031104	Incubator front move not possible	The incubator is not able to move forward or has made a forward move but cannot complete its full movement.	The incubator has been moved manually and does not recognize its current position or has some type of obstruction prohibiting it from moving forward.	Remove the main cover and visually check for obstructions i.e. extended washer loader rod, fallen reaction modules, false adjustments.
031105	Incubator back move not possible	The incubator is not able to move back or has made a backward move and cannot complete its required movement.	The incubator has been moved manually and does not recognize its current position.	Remove the main cover and visually check for obstructions i.e. extended washer loader rod, fallen reaction modules, false adjustments.
031101	Incubator not initialized	The incubator has not moved to its initial position	This subassembly was most likely moved manually and must be initialized before starting analyzer functions	Mark " incubator " in the [Machine is Halted!] dialog box then press [Send] and afterwards [Continue] .

Washer transport				
Message number	Message text	Description	Reasons	Recovery action
030102	Washer transport forward move not possible	The washer transport is not able to move forward or has moved forward and cannot complete its full movement	This error can be due to a faulty / incorrectly adjusted reaction module detection sensor located near the entrance to the measure chamber (this is only possible during reaction module clearing). In this case two reaction modules collide with another. It is also possible that there is another type of blockage in the washer channel i.e. the width of the washer channel is not properly adjusted or the washer transport rod itself is not properly adjusted.	<ul style="list-style-type: none"> • Check the washer channel for; <ol style="list-style-type: none"> 1. Reaction modules that have collided with each other, 2. Proper positioning of the transport rod and the pressure bearings 3. Pusher obstructing the washer channel 4. Improper washer lift positioning 5. Loose reflex sensor for the transport rod 6. Stepper card jumpers are correctly set • Correct all deficiencies and refer to relative chapter sections
030103	Washer transport backward move not possible	The washer transport is not able to move backward or has moved backward and cannot complete its full movement.	This error is most likely due to a faulty drive motor or a faulty reaction module that is eventually wider than the space of the adjusted washer channel.	See recovery action for error "030102" NOTE: When the adjustment of the transport rod is too tight, the rod will not be able to transport two cuvettes at the same time.
030101	Washer transport not initialized	The washer transport has not moved to its initial position.	The initial position (sensor) may be improperly adjusted. This element must be initialized before continuing with the progress of the analyzer.	Mark " washer transport " in the [Machine is Halted!] dialog box then press [Send] and afterwards [Continue].

Washer lift				
Message number	Message text	Description	Reasons	Recovery action
030202	Washer lift regulation up	The washer lift has not made the required movements in the predetermined time. (System cycles)	The washer lift up-movements are too slow. Probably due to the spring retainer. (The left side of the washer lift)	Remove the washer lift and check to ensure that the spring retainer is lubricated and free of dirt particles. • Check the hall sensor to ensure that it is close enough to the washer lift. (This ensures a proper triggering of the magnet to the hall sensor)
030203	Washer lift regulation down	The washer lift has not made the required movements in the predetermined time. (System cycles)	The washer lift down-movements are too slow. Probably due to the spring retainer. (The left side of the washer lift)	See Error 030202
030204	Washer lift down move not possible	The washer lift is not able to move downward or has moved down and cannot complete its full movement or has over extended its downward movement.	There is either a mechanical error or an obstruction present or the washer cannot detect its initial position.	Check for; 1. Obstructions in the washer 2. Improper adjustments in the service program 3. Proper encoder chosen in globals. Or Call for technical assistance
030205	Washer lift up move not possible	The washer lift is not able to move upward or has moved up and cannot complete its full movement or has over extended its upward movement.	This error usually occurs when the washer lift is above its initial position but still tries to ascend to the init position. (The washer has lost its step count)	• Check for; 1. Obstructions in the washer 2. Improper adjustments in the service program 3. Proper encoder chosen in globals 4. Defective WMP card 5. the washer lift fits correctly into the motor gears 6. a loose motor that does not transport the lift properly. Or Call for technical assistance
030201	Washer lift not initialized	The washer lift has not moved to its initial position.	This subassembly was most likely moved manually and must be initialized before starting analyzer functions.	Mark " washer lift " in the [Machine is Halted!] dialog box then press [Send] and afterwards [Continue] .
030202	Wash module moving up	The washer lift has some type of obstruction and is not able to move up.	Most likely the washer lift guide is not able to move freely or the motor gear is not properly aligned with the lift gear.	In this error it is necessary to turn the analyzer off, manually push the washer lift down, and restart the analyzer. If the error has not been corrected, call for technical assistance.
030203	Wash module moving down	The washer lift has some type of obstruction and is not able to move down.	Most likely the washer lift guide is not able to move freely or the motor gear is not properly aligned with the lift gear.	In this error it is necessary to turn the analyzer off, manually push the washer lift down, and restart the analyzer. If the error has not been corrected, call for technical assistance.

Pusher				
Message number	Message text	Description	Reasons	Recovery action
020202	Pusher regulation front	The pusher has not made the required movements in the predetermined time. (System cycles)	The pusher movements are too slow. There is probably some type of hindrance in the movement.	1. Check the retainer clip on the pusher belt to ensure proper installation. 2. Check the guide track for cleanliness. After cleaning, lubricate with a light coat of silicon spray.
020203	Pusher regulation back	The pusher has not made the required movements in the predetermined time. (System cycles)	The pusher movements are too slow. There is probably some type of hindrance in the movement.	1. Check the retainer clip on the pusher belt to ensure proper installation. 2. Check the guide track for cleanliness. After cleaning, lubricate with a light coat of silicon spray.
020204	Pusher move forward not possible	The pusher is not able to move forward or has moved forward and cannot complete its full movement.	This occurs when an obstruction is present i.e. the chamber transport has not been initialized or the tension retaining clip for the pusher belt (found on the underside of the pusher) is located in the wrong position. If this is so, this error will be displayed at the earliest during initialization, or a reaction module has missed a step in the washer transport.	Visually check the movements of the reaction modules from washer transport to pusher. In most cases this is not a problem from the pusher but the washer transport. If it is noticed that the washer transport has missed a step by transporting reaction modules it will be necessary to adjust the washer transport. Flooding in the washer channel without the "washer flooding" error is usually a common outcome of this problem. It may also be possible that the previously mentioned retaining clip on the pusher must be adjusted.
020205	Pusher move backward not possible	The pusher is not able to move backward or has moved backward and cannot complete its full movement.	This occurs when an obstruction is present i.e. the chamber transport has not been initialized or the tension retaining clip for the pusher belt (found on the underside of the pusher) is located in the wrong position. If this is so, this error will be displayed at the earliest during initialization, or a reaction module has missed a step in the washer transport.	Visually check the movements of the reaction modules from washer transport to pusher. In most cases this is not a problem from the pusher but the washer transport. If it is noticed that the washer transport has missed a step by transporting reaction modules it will be necessary to adjust the washer transport. Flooding in the washer channel without the "washer flooding" error is usually a common outcome of this problem. It may also be possible that the previously mentioned retaining clip must be adjusted.
020201	Pusher not initialized	The pusher has not moved to its initial position.	This occurs when an obstruction is present i.e. the tension retaining clip for the pusher belt (found on the underside of the pusher) is located in the wrong position or a reaction module may be lodged between the washer channel and the pusher.	Mark " pusher " in the [Machine is Halted!] dialog box then press [Send] and afterwards [Continue] .

Back transport				
Message number	Message text	Description	Reasons	Recovery action
030302	Backtrans move forward not possible	The back transport is not able to move forward or has moved forward and cannot complete its full movement.	Either a mechanical error prevents the incubator loader from moving or the incubator loader has not been properly adjusted in "service". Note: This is a common message for the reflex sensor or initialization holes of the transport rod.	A technician is needed to check for the proper function of the reflex sensor located under the back transport or for play between the motor and the geared rod.
030303	Backtrans move backward not possible	The back transport is not able to move backward or has moved backward and cannot complete its full movement.	Either a mechanical error prevents the incubator loader from moving or the incubator loader has not been properly adjusted in "service". Note: This is a common message for the reflex sensor or initialization holes of the transport rod.	A technician is needed to check for the proper function of the reflex sensor located under the back transport or for play between the motor and the geared rod.
030301	Backtrans not initialized	The back transport is not able to find its initial position.	This subassembly was most likely moved manually and must be initialized before starting analyzer functions.	Mark " stacker " in the [Machine is Halted!] dialog box then press [Send] and afterwards [Continue] .

Measurement chamber Transport				
Message number	Message text	Description	Reasons	Recovery action
040102	Chamber transport move not possible	The chamber transport is not able to rotate.	This is due to a mechanical obstruction or an initialization has not taken place. Or the relative sense is defective.	Carefully remove the measurement chamber cover and visually check for obstructions i.e. jammed reaction modules, evidence of crystallization (this can be seen as a white powder-like substance).
040101	Chamber transport not initialized	The chamber transport has not moved to its initial position.	This subassembly was most likely moved manually and must be initialized before starting analyzer functions.	Mark " chamber transport " in the [Machine is Halted!] dialog box then press [Send] and afterwards [Continue] .

Message number	Message text	Measurement chamber		
		Description	Reasons	Recovery action
040202	Chamber lift regulation up	The chamber lift has not made the required movements in the predetermined time. (Time frame)	The chamber lift-up movements are too slow. Probably due to a previous flooding of the measurement chamber or the chamber transport rod is not correctly aligned.	Carefully remove the measurement chamber cover and visually check for evidence of crystallization either on the chamber lift guide or the chamber lift transport rod (this can be seen as a white powder-like substance).
040203	Chamber lift regulation down	The chamber lift has not made the required movements in the predetermined time. (Time frame)	The chamber lift-down movements are too slow. Probably due to a previous flooding of the measurement chamber or the chamber lift transport rod is not correctly aligned.	Carefully remove the measurement chamber cover and visually check for evidence of crystallization either on the chamber lift guide or the chamber lift transport rod (this can be seen as a white powder-like substance).
040204	Chamber lift move up not possible	The chamber lift is not able to move upward or has moved up and cannot complete its full movement or has over extended its upward movement.	The chamber lift-up movements are blocked. Probably due to a previous flooding of the measurement chamber which produces a clogging behind the lift guide or the chamber transport rod is not correctly aligned.	Carefully remove the measurement chamber cover and visually check for evidence of crystallization either on the chamber lift guide or the chamber lift transport rod (this can be seen as a white powder-like substance). It is also possible that the chamber lift shots have come out of their track, or the reflex sensor (located on the underside of the measurement chamber) is defect.
040205	"Chamber lift move down not possible"	The chamber lift is not able to move downward or has moved down and cannot complete its full movement or has over extended its downward movement.	The chamber lift-down movements are blocked. Possibly due to a previous flooding of the measurement chamber or the chamber transport rod is not correctly aligned or a reaction module is jammed in the measure chamber canal.	Carefully remove the measurement chamber cover and visually check for evidence of crystallization either on the chamber lift guide or the chamber lift transport rod (this can be seen as a white powder-like substance). It is also possible that the chamber lift shots have come out of their track, or the reflex sensor (located on the underside of the measurement chamber) is defect.
040201	Chamber lift not initialized	The chamber lift has not moved to its initial position.	This subassembly was most likely moved manually and must be initialized before starting analyzer functions.	Mark " chamber Lift " in the [Machine is Halted!] dialog box then press [Send] and afterwards [Continue] .
040206	No cuvette in chamber	At the expected time of measuring there was no cuvette detected in the measurement chamber or a cuvette has passed through the measurement chamber without being recognized.	This is a problem of the minimum cuvette value found in "globals".	It is necessary to adjust the minimum cuvette value. This can only be accomplished by a technician.

040207	Cuvette not moved out from chamber	A cuvette has entered the measurement chamber and because of some type of obstruction, it cannot exit the measurement chamber. Note: This message is in conjunction with "chamber transport move not possible".	This error is possibly due to a previous flooding of the measurement chamber, which results in the misalignment of the chamber transport rods.	Mark " chamber transport " in the [Machine is Halted!] dialog box then press [Send] repeat this so long until the cuvette completely exits the measurement chamber, then press [Continue].
--------	------------------------------------	--	--	--

Bumps				
Message number	Message text	Description	Reasons	Recovery action
030701	Wash Soak not soak normally. Please shut down power and observe problem carefully	Fluid has been detected between the suction and prime needles on at least one of the three pairs of wash needles.	This usually indicates one of the following: <ol style="list-style-type: none"> 1. One or more washer needles are clogged. 2. The Alitea tubes (found on the peristaltic pump) have been worn down and need to be replaced. 3. The washer suction position is adjusted too low and cannot aspirate the fluid in the appropriate time frame. 4. A washer tube may have been bent during installation and has retained this position 	Check the washer for liquid drops between the injection and aspiration needles. Remove any liquid that may be present. Press [Continue], it may be necessary to repeat this procedure several times. If this message persists, please contact technical assistance.
040501	Soak chamber not soak normally	Fluid has been detected between the suction needle and the fluid sensing rod in the measurement chamber	This error indicates either a clogged aspiration tube in the measurement chamber or the aspiration tube has not been connected correctly or waste pump deflection.	Carefully remove the measurement chamber cover and visually check for flooding or evidence of crystallization on the chamber-flooding sensor (this can be seen as a white hard-like substance). Also check for proper connection of the neoprene tube to the aspiration needle as well as possible leaks in the tube. It may also be that the aspiration needle is clogged. If this problem is found, the needle must be removed and cleaned (1% hypo chloride solution is recommended for cleaning). After cleaning, dry the inside of the tube with compressed air
030401	WashInj_1 not inject normally. Please shut down power and observe problem carefully	Fluid has been detected between the suction and prime needles on 1st wash needles.	<ol style="list-style-type: none"> 1. One washer needles are clogged. 2. A washer tube may have been bent during installation and has retained this position 3. Wash pump is defective. 	Disconnect one cable on 1st washer needles. Return to system test and mark only the washer (BGW, LC-Le, & LC-Ri should be set to 0). Check to see if all washer needles are aspirating correctly. If this is not the case, notify technical assistance.
030501	WashInj_2 not inject normally. Please shut down power and observe problem carefully	Fluid has been detected between the suction and prime needles on 2nd wash needles.	<ol style="list-style-type: none"> 1. One washer needles are clogged. 2. A washer tube may have been bent during installation and has retained this position 3. Wash pump is defective 	Disconnect one cable on 2nd washer needles. Return to system test and mark only the washer (BGW, LC-Le, & LC-Ri should be set to 0). Check to see if all washer needles are aspirating correctly. If this is not the case, notify technical assistance.

030601	WashInj_3 not inject normally. Please shut down power and observe problem carefully	Fluid has been detected between the suction and prime needles on at least one of the three pairs of wash needles.	<ol style="list-style-type: none"> 1. One washer needles are clogged. 2. A washer tube may have been bent during installation and has retained this position 3. Wash pump is defective 	Disconnect one cable on 3rd washer needles. Return to system test and mark only the washer (BGW, LC-Le, & LC-Ri should be set to 0). Check to see if all washer needles are aspirating correctly. If this is not the case, notify technical assistance.
040301	Start_1 not inject normally, please shut down power and observe problem carefully	Starter reagent 1 is not inject normally.	Starter reagent 1 pump is defective.	Call for technical assistance
040401	Start_2 not inject normally, please shut down power and observe problem carefully	Starter reagent 2 is not inject normally.	Starter reagent 2 pump is defective.	Call for technical assistance

Pipettor				
Message number	Message text	Description	Reasons	Recovery action
020101	The horizontal outer track of Sample Arm can not be initialized		cannot detect optocoupler for the initial position in the horizontal outer track	Call for technical assistance
020102	The outer of SampleArm can not be moved clockwise		encoder of horizontal outer track determine that the position did not change when moving	Call for technical assistance
020103	The outer of SampleArm can not be moved counter-clockwise		encoder of horizontal outer track determine that the position did not change when moving	Call for technical assistance
020117	The horizontal inner track of SampleArm can not be initialized		cannot detect the initial position of the horizontal inner track optocoupler	Call for technical assistance
020118	The inner of SampleArm can not be moved clockwise		encoder of horizontal outer track determine that the position did not change when moving	Call for technical assistance
020119	The inner of SampleArm can not be moved counter-clockwise		encoder of horizontal outer ring determine that the position did not change when moving	Call for technical assistance
020133	SampleArm can not be initialized on vertical		Resistance or jam	Call for technical assistance
020134	SampleArm can not be moved down		Resistance or jam	Call for technical assistance
020135	SampleArm can not be moved up		Resistance or jam	Call for technical assistance
020149	The Inject pump of SampleArm can not be initialized			Call for technical assistance
020165	SampleArm can not detect liquid			Call for technical assistance
020181	SampleArm detect blood clot			Call for technical assistance

Appendix A

Needle Coordinates

Coordinates

1.1 Preparation for coordinate.....	2
1.2 Procedures of Coordinates.....	4
1.3 Adjustment of reference position.....	4
1.4 Adjustment of pipetting needle	7
1.4.1 Adjustment of< First Sampling> position	8
1.4.2 Adjustment of Second Sampling after Incubate	11
1.4.3 Adjustment of Second Sampling after Wash.....	14
1.5 Washing position adjust.....	19
1.6 Sample Reagent area position adjust.....	21
1.6.1 Sample area position adjust.....	22
1.6.2 Reagent area position Adjust.....	26
1.7 Z-Dispense position adjust	33
1.8 Adjustment of the pipetting needle in Z- Start position.....	37

1 Coordinates

After installment of the analyzer and computer, the pipettors' plane position and the maximum position should be coordinated at first.

1.1 Preparation for coordinate

Using two reaction modules fill 75 μ l of water and then these two cuvettes respectively place to first slot of incubator and one position in front of the right pipetting position

For Maglumi 600, using three tubes filled with 100 μ l of water should be respectively placed at the track#1, 1st and 8th position sample area in, track#2, 8th position in sample area.

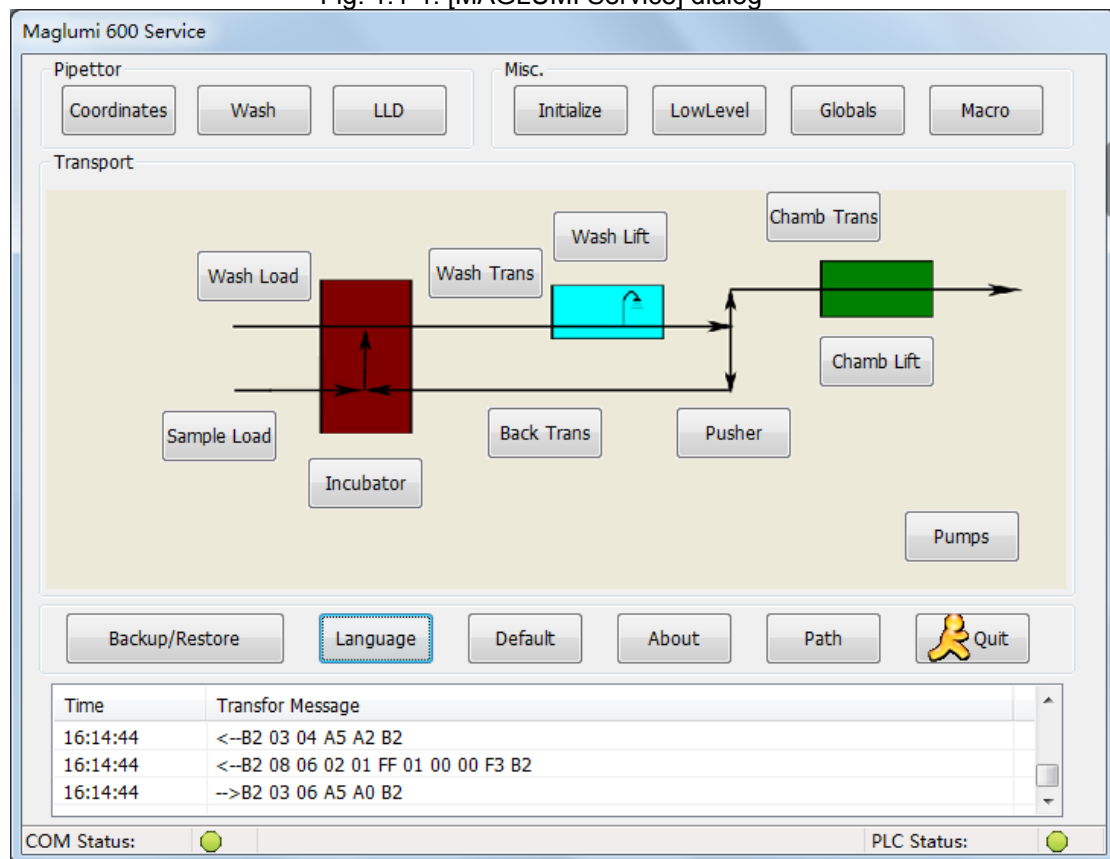
For Maglumi 800, using three tubes filled with 100 μ l of water should be respectively placed at the track#1, 1st and 8th position sample area in, track#5, 8th position in sample area.

Fill the 1st vial (the position of magnetic particle) of the reagent kit used to Coordinate with 200 μ l water, while the 2nd vial (the position of low calibrator) with 200 μ l water, the 4th vial (the position of displacer) with 500 μ l water and the 7th vial (the position of diluter) with 1000 μ l water.

Then slide the reagent kit into the track#1 of Reagent Area.

Switch on to start the analyzer. Turn on the PC system. Double click the **[Maglumi Service]** icon on the desktop, if the connection between the PC and the analyzer is OK, entered password (snibe923), the **[Maglumi Service]** Interface will be shown as below Fig 1.1-1

Fig. 1.1-1: [MAGLUMI Service] dialog



Press **<Initialize>** button on the top center of the dialog to execute initialization of the plane assemblies.

When the initialization finishes, press **<Incubator>** button to open the

[Incubator] dialog. Select Backtr in the **[target position]**, click

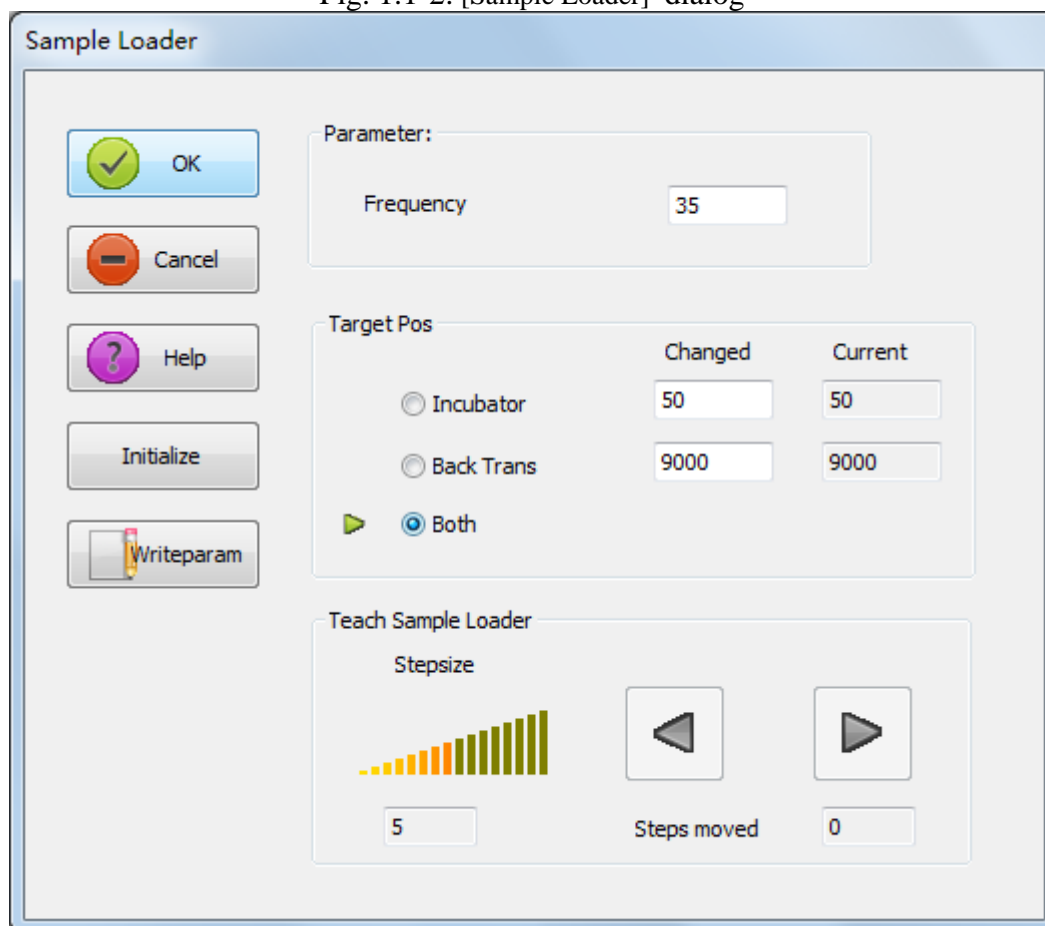


icon, back to the **[Maglumi Service]** interface . Click



button to open **[Sample Loader]** dialog.

Fig. 1.1-2: [Sample Loader] dialog



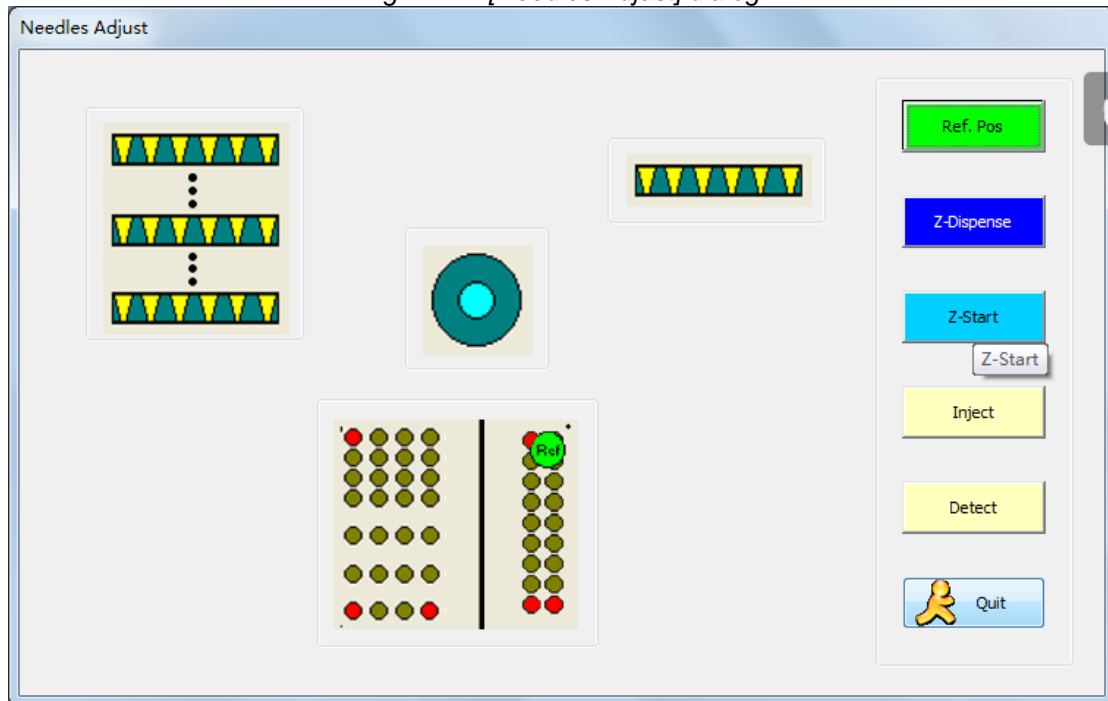
Click **<both>** icon, one reaction module will be moved to the first pipetting position

Click **<OK>** icon, back to the **[Maglumi Service]** dialog

1.2 Procedures of Coordinates

Click the upper left corner  button of **[Maglumi 600 Service]** interface to open **[Needles Adjust]** dialog.

Fig. 1.2-1: *[Needles Adjust]* dialog



1.3 Adjustment of reference position


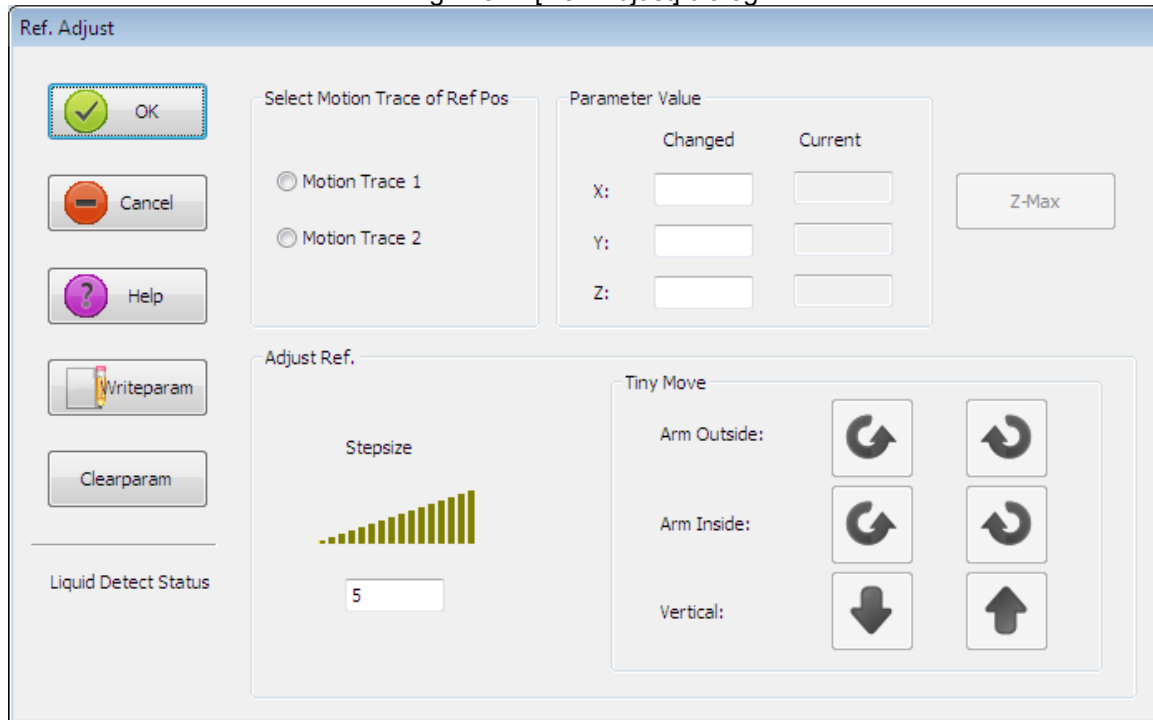









Click  button on upper right corner of the **[Needles Adjust]** interface to open **[Ref. Adjust]** dialog.

Fig. 1.3-1: [Ref. Adjust] dialog



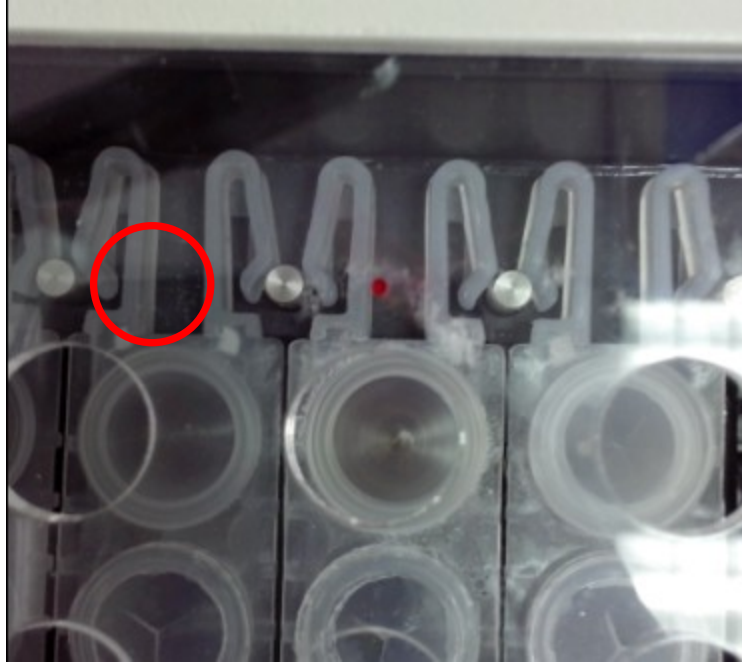
Select **<Motion Track1>** in the field of **[Select Motion Track]** of reference position. To set the stepsize-bar can adjust value of the stepsize. Set bigger stepsize firstly, then press the  icon to move the pipettor needle downward. When the needle gets close to the target position, set stepsize smaller, and then click the Clockwise direction icon  of outside arm, click the Counterclockwise direction icon  of outside arm, click the Clockwise direction  of inside arm, click the counterclockwise direction  of inside arm. making the needle tip just above the center point of **reference position**, Then press  and  icon to make the needle tip higher than the reference position center point by 0.5mm. Save the parameters with  icon, then press **<OK>** to exit. And then adjust the **Motion Track 2** as the way of **Motion Track1**, click  to exit the interface.



Ensure that Motion Track1 and Motion Track2 adjust the same reference position.


Requirement:

1. Needle tip should be located in the center point of **the reference position**, which is located on the protection board of reagent area.

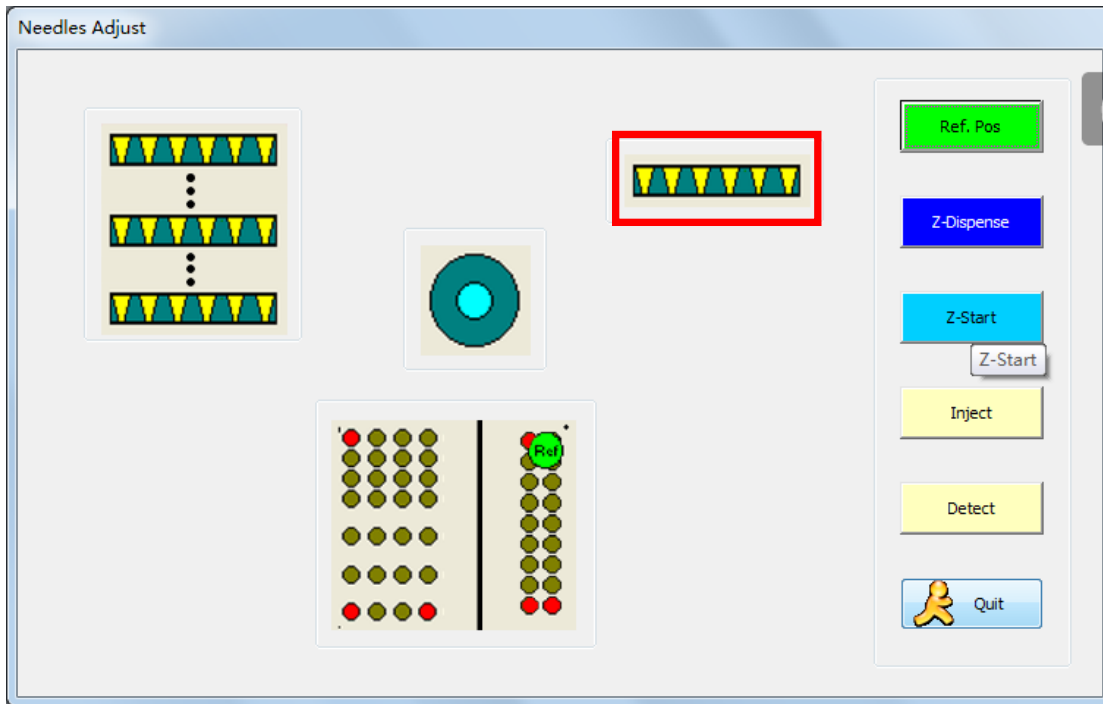
Reference Position

2. The Needle tip higher than the **reference position** center point by 0.5mm



After adjust the pipetting needle, click  icon to exit the interface.

1.4 Adjustment of pipetting needle




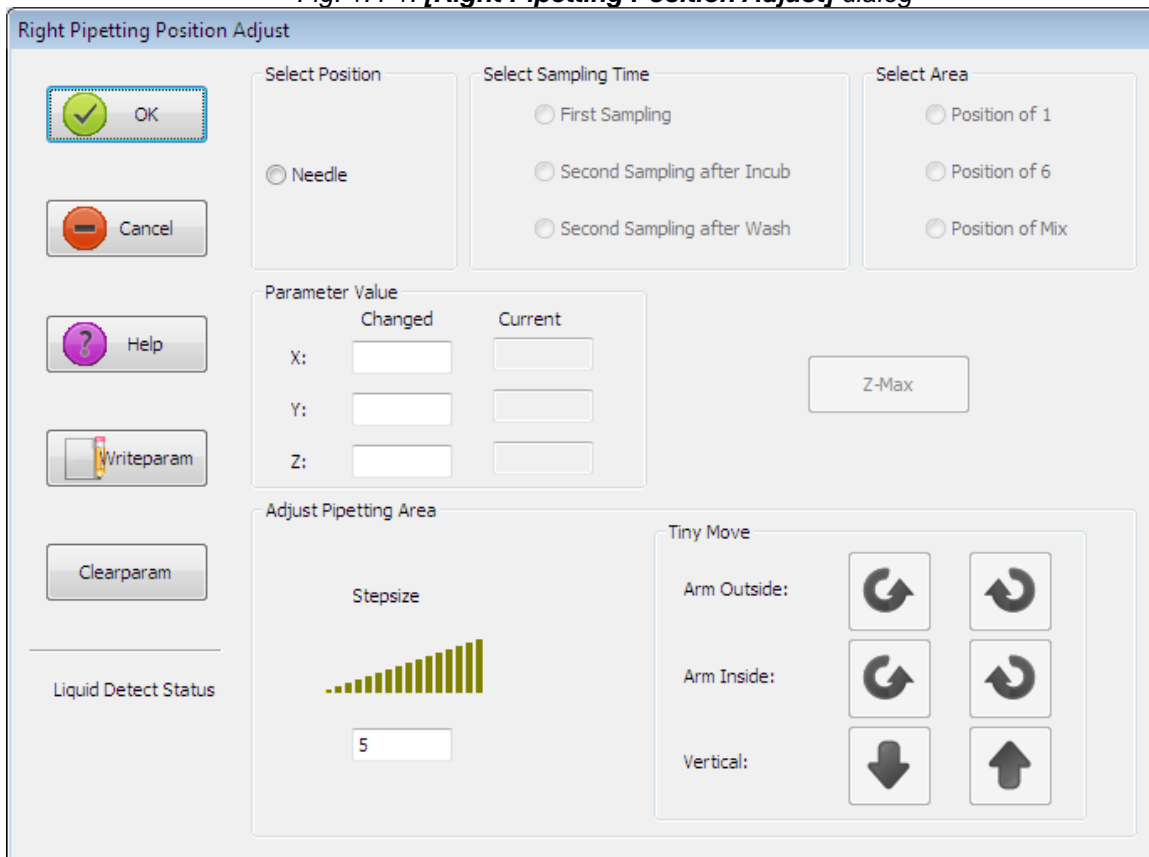
Click the  icon in the right side of **[Needles Adjust]** interface to open the **[Right Pipetting Position Adjust]** dialog

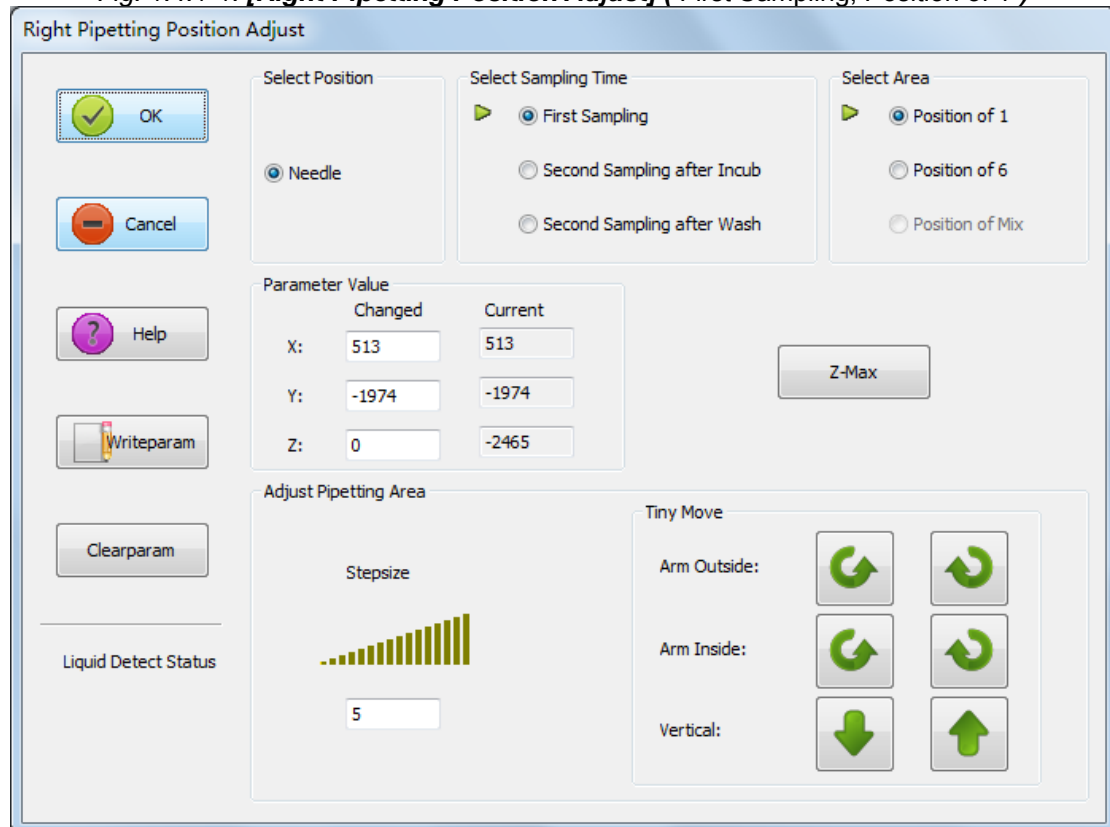
Fig. 1.4-1: **[Right Pipetting Position Adjust]** dialog











1.4.1 Adjustment of < First Sampling> position

Select **First Sampling** in the field of **[Select Sampling Time]**
 Select the **Position of 1** in the field of **[Select Area]**.

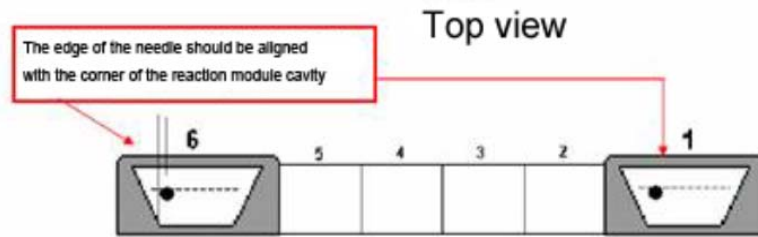
Fig. 1.4.1-1: **[Right Pipetting Position Adjust]** (First Sampling, Position of 1)



To set the stepsize-bar can adjust value of the stepsize. Set bigger stepsize firstly, click the icon  to downward the pipettor. When the pipettor get close to the reaction module, set stepsize smaller. Then click the Clockwise direction  icon of outside arm, click the Counterclockwise direction  icon of outside arm, click the Clockwise direction  icon of inside arm, click the counterclockwise direction  icon of inside arm. Make the needle tip just above the target position, click upward  icon, downward  icon to make the needle tip reaches the Z_{max} in module. Save the parameters with  icon.

Requirements:

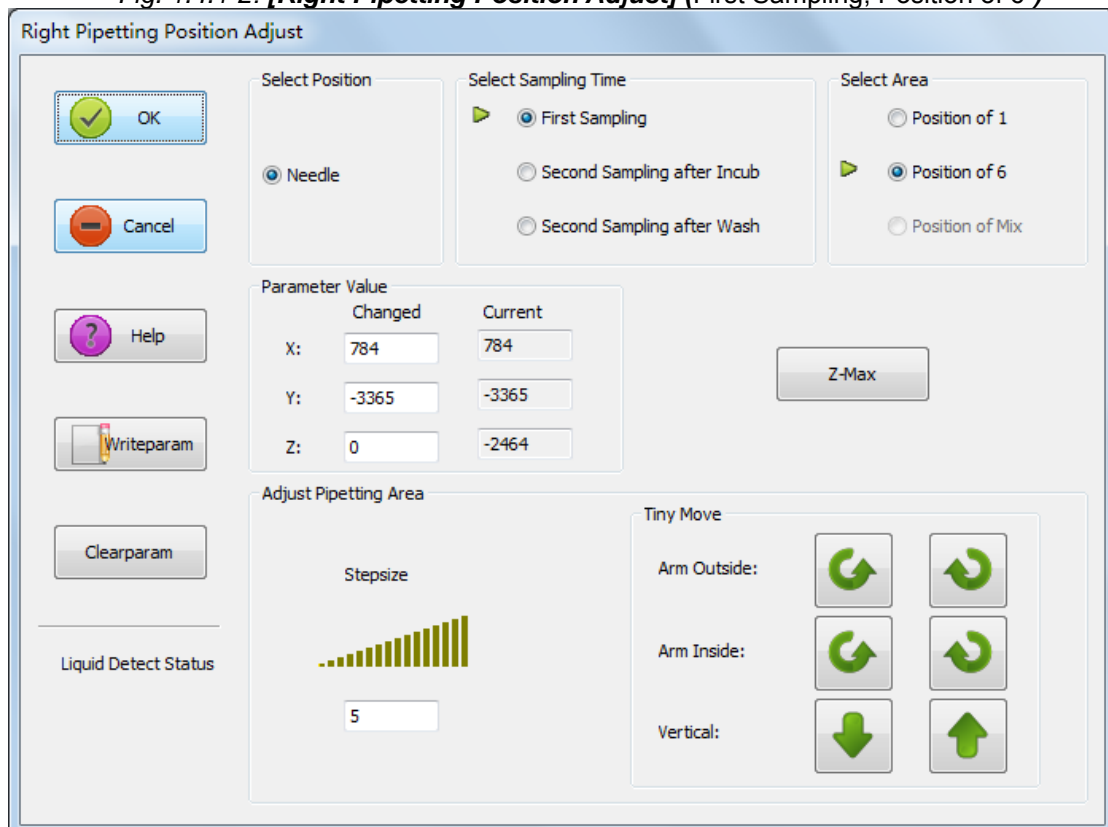
1. Plane position: The edge of the needle should be aligned with the corner of the reaction module cavity.











2. Zmax in module: click  and  icon to adjust the pipettor needle. When the needle tip reaches the liquid level, the LLD'light would be on, then press  icon to save the parameters.

Select Position of 6 in [Select Area]

Fig. 1.4.1-2: [Right Pipetting Position Adjust] (First Sampling, Position of 6)

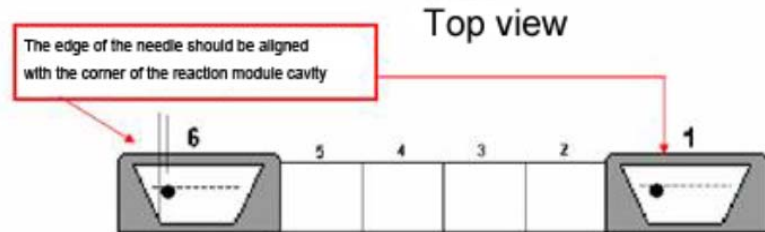




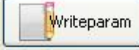
To set the stepsize-bar can adjust value of the stepsize. Set bigger stepsize firstly, click the icon  to downward the pipettor. when the pipettor get close to the reaction module , set stepsize smaller. Then click the Clockwise direction  icon of outside arm, click the Counterclockwise direction  icon of outside arm, click the

Clockwise direction  icon of inside arm , click the counterclockwise direction  icon of inside arm. Make the needle tip just above the target position, click upward  icon, downward  icon to make the needle tip reaches the Z_{max} in module. Save the parameters with  icon.

Requirements:

1.Plane position: The edge of the needle should be aligned with the corner of the reaction module cavity.

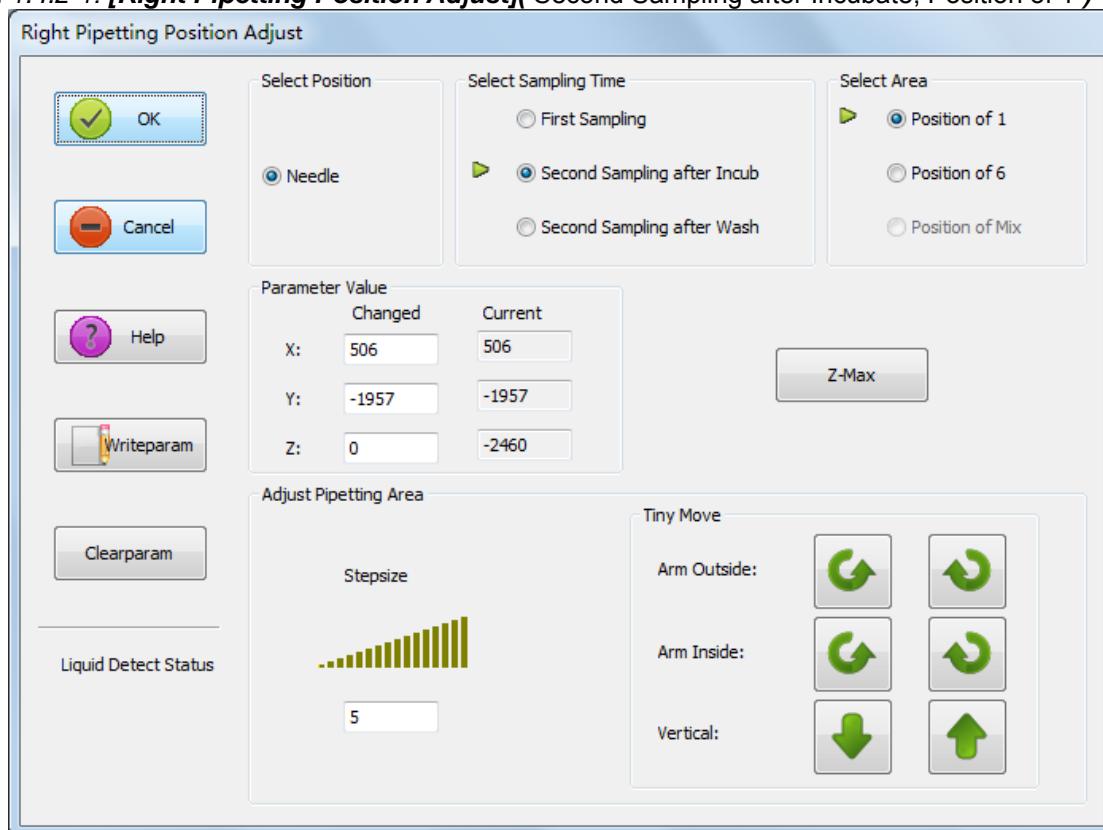










2. Z_{max} in module: click  and  icon to adjust the pipettor needle. When the needle tip reaches the liquid level, the LLD light would be on, then press  icon to save the parameters.

1.4.2 Adjustment of Second Sampling after Incubate

Select **Second Sampling after Incubate** in the field of **[Select Sampling Time]**
select the **Position of 1** in the field of **[Select Area]**

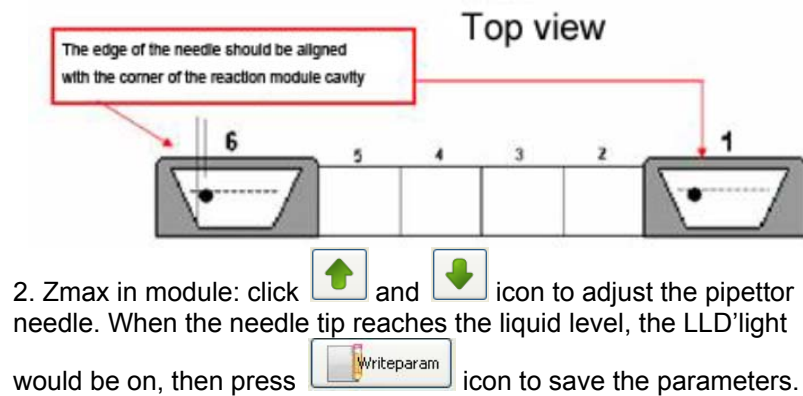
Fig. 1.4.2-1: **[Right Pipetting Position Adjust]**(Second Sampling after Incubate, Position of 1)



To set the stepsize-bar can adjust value of the stepsize. Set bigger stepsize firstly, click the icon  to downward the pipettor. When the pipettor get close to the reaction module, set stepsize smaller. Then click the Clockwise direction  icon of outside arm, click the Counterclockwise direction  icon of outside arm, click the Clockwise direction  icon of inside arm, click the counterclockwise direction  icon of inside arm. Make the needle tip just above the target position, click upward  icon, downward  icon to make the needle tip reaches the Z_{max} in module. Save the parameters with  icon.

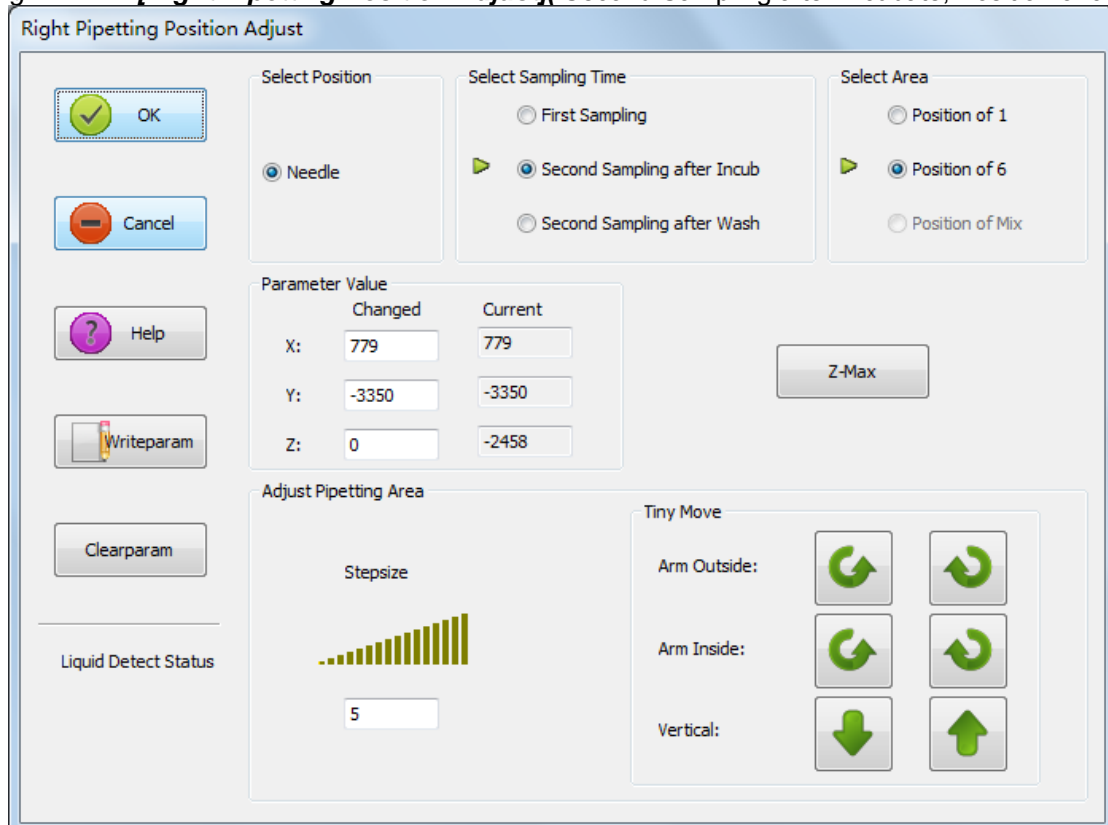
Requirements:

1.Plane position: The edge of the needle should be aligned with the corner of the reaction module cavity.






Select the **Position of 6** in the field of **[Select Area]**

Fig. 1.4.2-2: **[Right Pipetting Position Adjust]**(Second Sampling after Incubate, Position of 6)



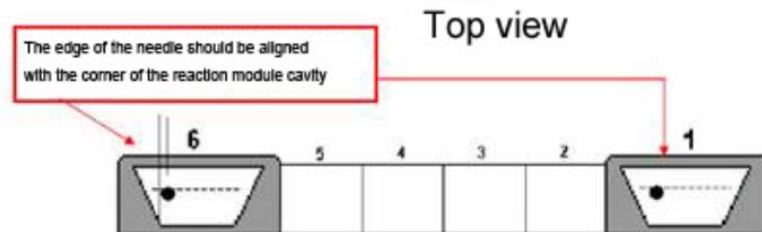
To set the stepsize-bar can adjust value of the stepsize. Set bigger stepsize firstly,click the icon to downward the pipettor. When the pipettor get close to the reaction module , set stepsize smaller.




Then click the Clockwise direction icon of outside arm, click the Counterclockwise direction icon of outside arm, click the Clockwise direction icon of inside arm , click the couterclockwise direction icon of inside arm. Make the needle tip just above the

target position, click upward  icon, downward  icon to make the needle tip reaches the Z_{max} in module. Save the parameters with  icon.

Requirements:

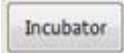

1. Plane position: The edge of the needle should be aligned with the corner of the reaction module cavity.



2. Z_{max} in module: click  and  icon to adjust the pipettor needle. When the needle tip reaches the liquid level, the LLD light would be on, then press  icon to save the parameters.

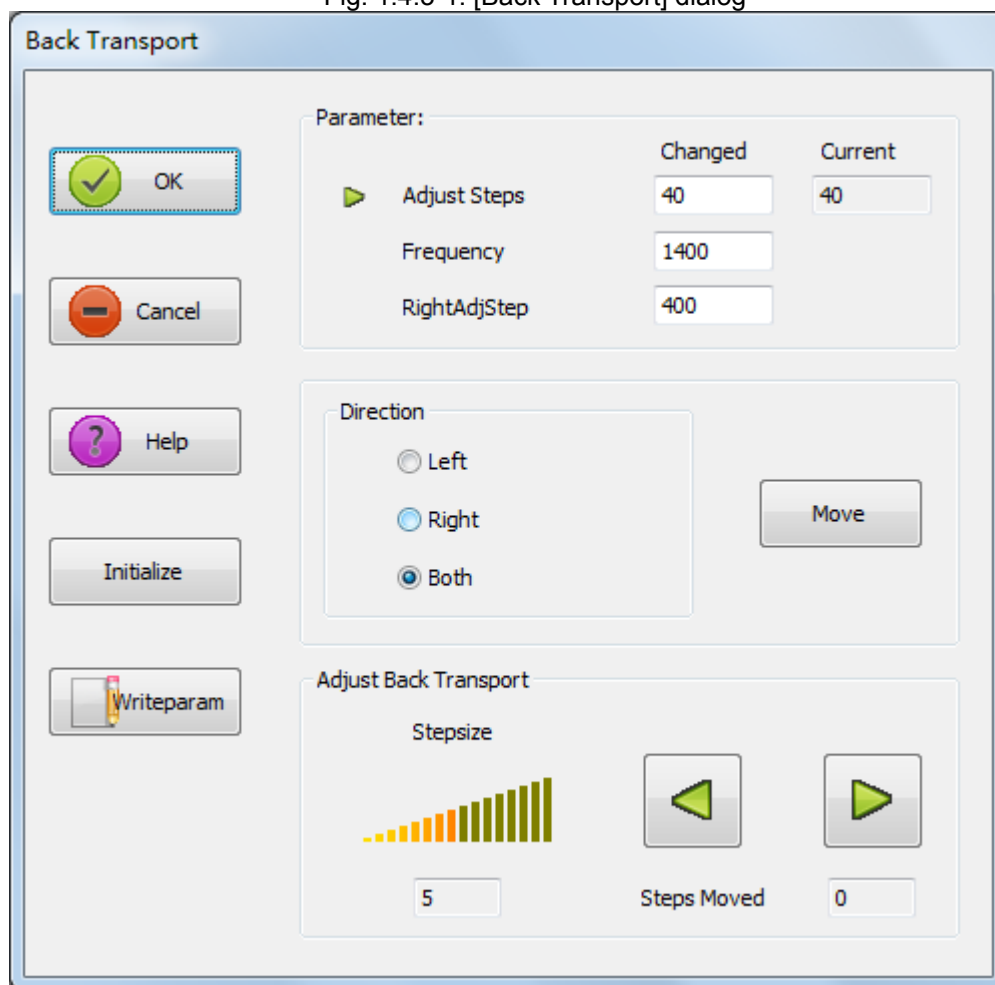
1.4.3 Adjustment of Second Sampling after Wash


Back to **[Maglumi 600 Service]** interface.

Click  icon to open **[Incubator]** dialog. Select Backtransport Position in the field of **[Target Position]**, click  icon, back to **[Maglumi Service]** dialog

Press  icon in **[Maglumi 600 Service]** interface to open **[Back Transport]** dialog

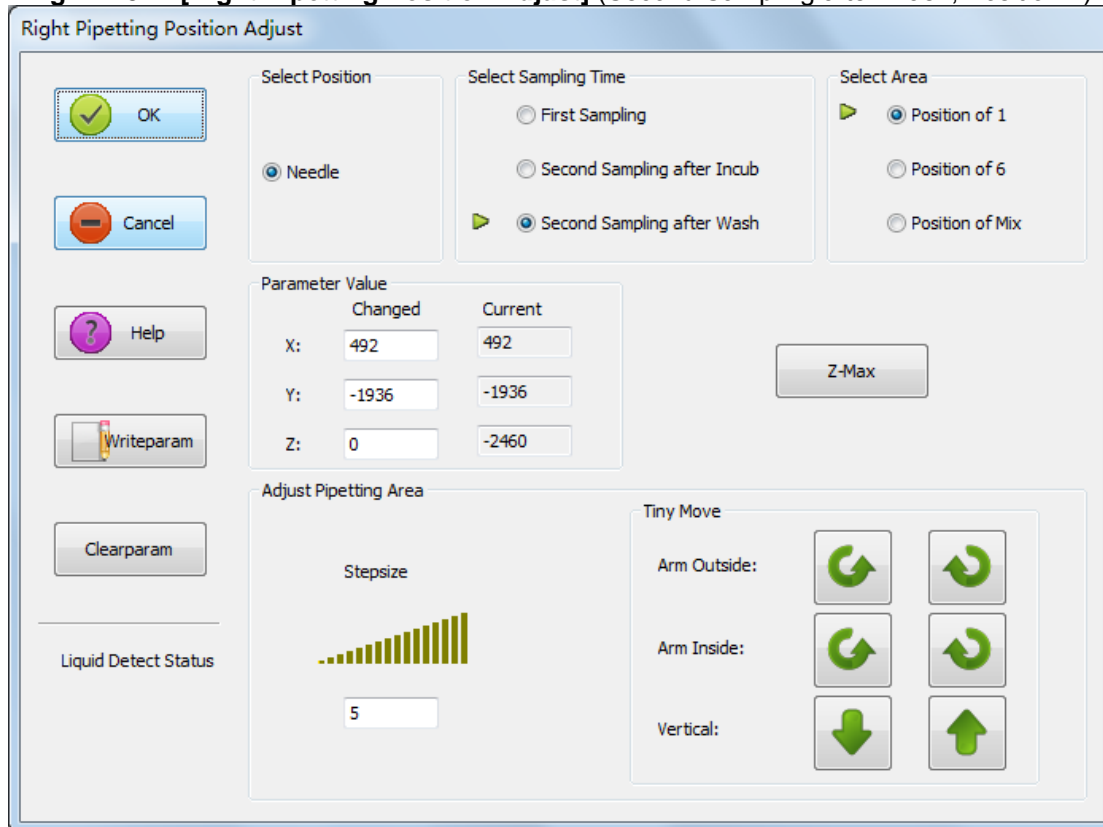
Fig. 1.4.3-1: [Back Transport] dialog











Click **<Move>** icon, transport 1 reaction module to the position of **Second Sampling after Wash**, and push one cuvette back to Slot 1 of Incubator. Click  icon, back to **[Maglumi Service]** dialog

Select **Second Sampling after Wash** in **[Select Sampling Time]** interface
 Select **Position 1** in **[Select Area]**

Fig. 1.4.3-2: [Right Pipetting Position Adjust] (Second Sampling after Wash, Position 1)

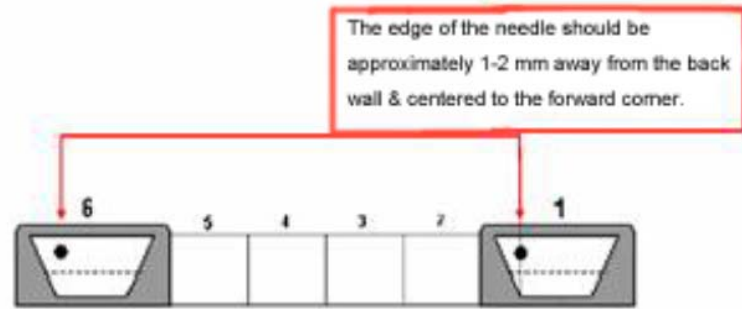





To set the stepsize-bar can adjust value of the stepsize. Set bigger stepsize firstly, click the icon  to downward the pipettor. When the pipettor get close to the reaction module, set stepsize smaller.

Then click the Clockwise direction  icon of outside arm, click the Counterclockwise direction  icon of outside arm, click the Clockwise direction  icon of inside arm, click the counterclockwise direction  icon of inside arm. Make the needle tip just above the target position, click upward  icon, downward  icon to make the needle tip reaches the Z_{max} in module. Save the parameters with  icon.

Requirements:

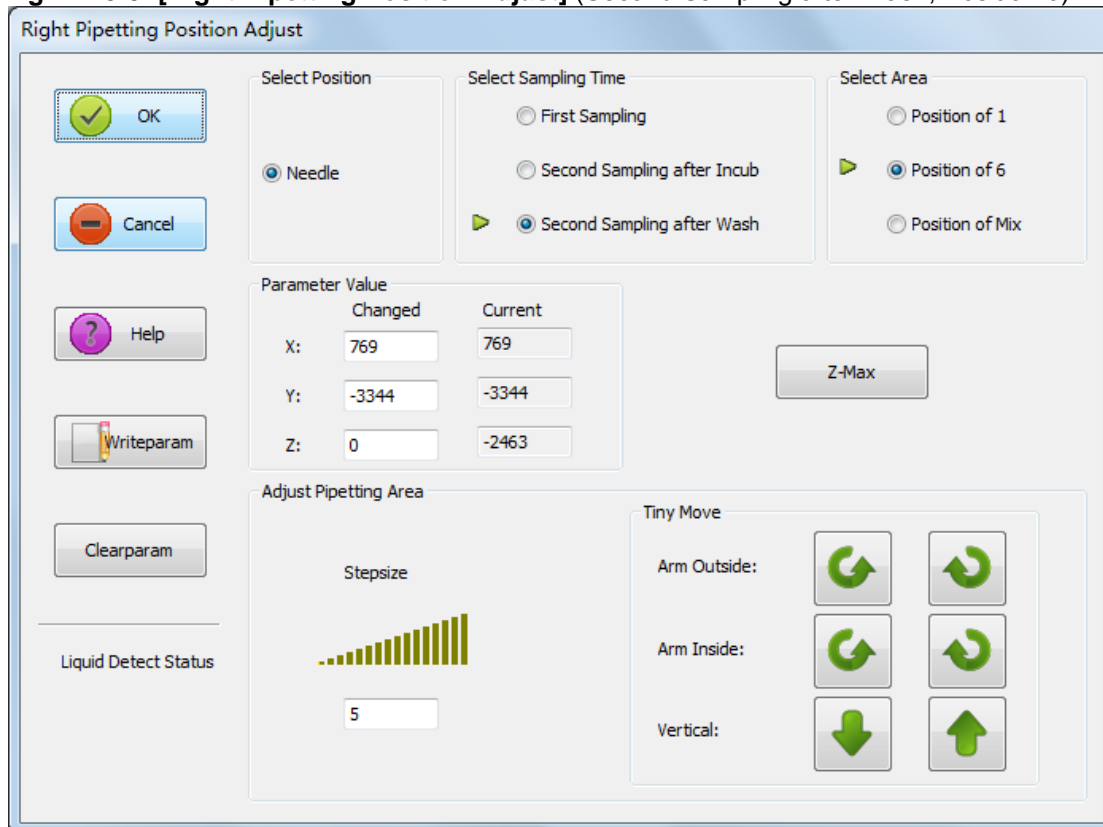
1. Plane : The edge of the needle should be approximately 1-2 mm away from the back wall & centered to the forward corner.




2. Zmax in module: click to open to open  ,  icon to adjust the pipettor needle. When the needle tip reaches the liquid level, the LLD light would be on, then press  icon to save the parameters.





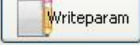
Select Position of 6 in [Select Area]

Fig. 1.4.3-3: [Right Pipetting Position Adjust] (Second Sampling after Wash, Position 6)



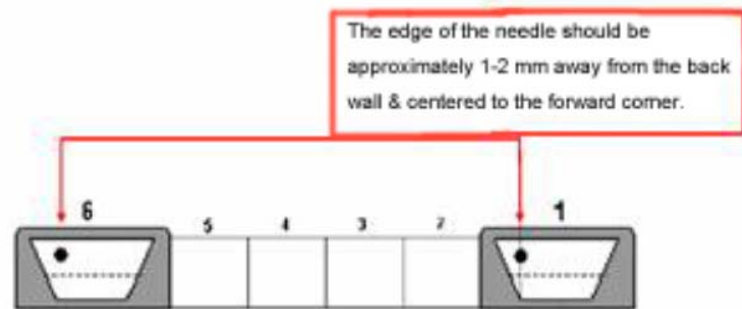
To set the stepsize-bar can adjust value of the stepsize. Set bigger stepsize firstly,click the icon  to downward the pipettor. When the pipettor get close to the reaction module , set stepsize smaller.




Then click the Clockwise direction  icon of outside arm, click the Counterclockwise direction  icon of outside arm, click the

Clockwise direction  icon of inside arm , click the counterclockwise direction  icon of inside arm. Make the needle tip just above the target position, click upward  icon, downward  icon to make the needle tip reaches the Z_{max} in module. Save the parameters with  icon.

Requirements:

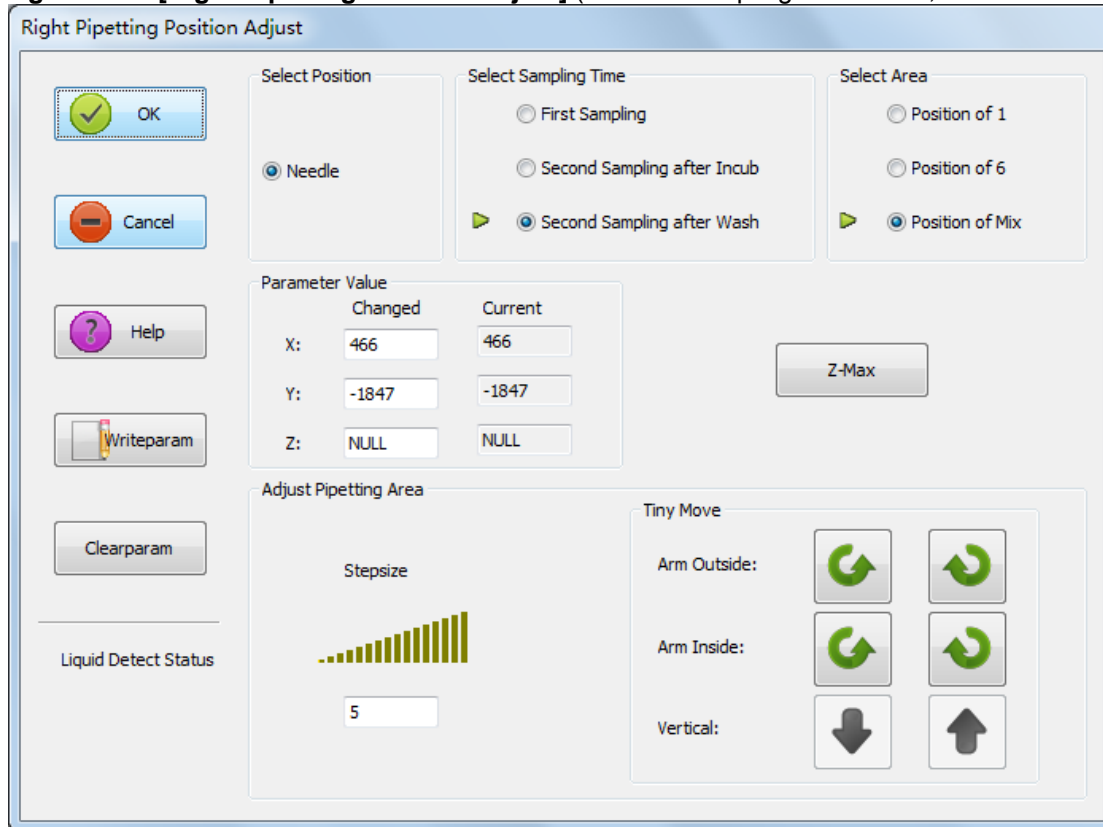
1. Plane : The edge of the needle should be approximately 1-2 mm away from the back wall & centered to the forward corner.







2. Z_{max} in module: click  ,  icon to adjust the pipettor needle. When the needle tip reaches the liquid level, the LLD'light would be on, then press  icon to save the parameters.

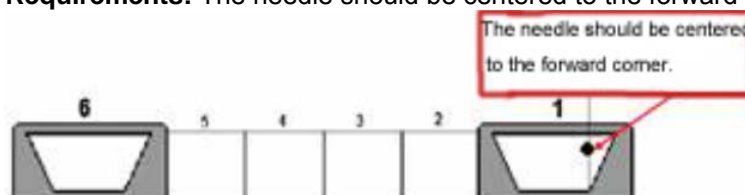
Select Position of Mix in [Select Area]

Fig. 1.4.3-4: [Right Pipetting Position Adjust] (Second Sampling after Wash, Position of Mix)



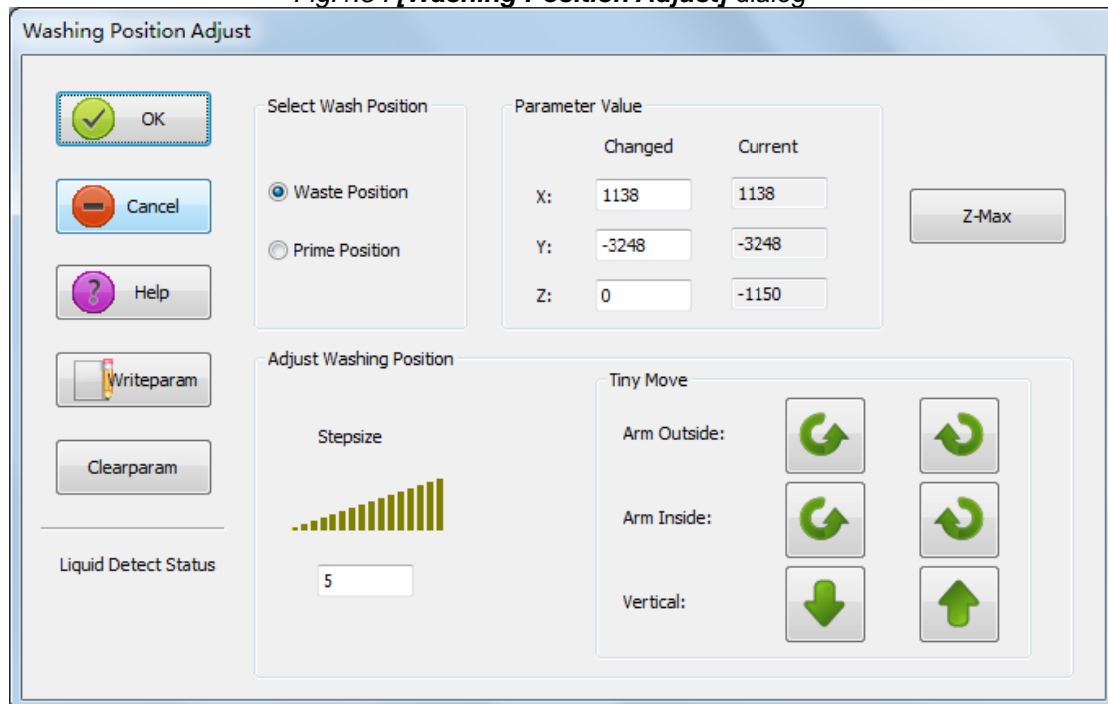
Then click the Clockwise direction  icon of outside arm, click the Counterclockwise direction  icon of outside arm, click the Clockwise direction  icon of inside arm , click the couterclockwise direction  icon of inside arm, adjust the Plane Position of Pipetting Needle.

Requirements: The needle should be centered to the forward corner.










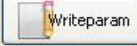
1.5 Washing position adjust

Click the washing position icon  in the **[Needles Adjust]** dialog to open the **[Washing Position Adjust]** dialog.

Fig. 1.5 : **[Washing Position Adjust]** dialog

Select **[Waste Position]** or **[Prime Position]** in **[Select Area]**.

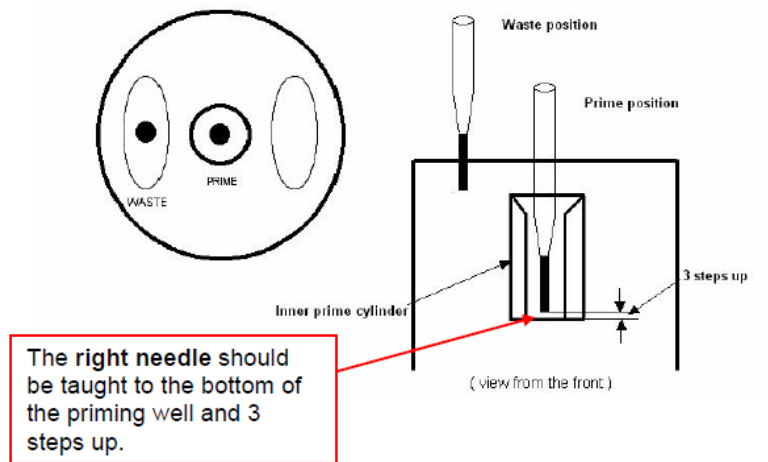
To set the stepsize-bar can adjust value of the stepsize. Set bigger stepsize firstly, then press the  icon to move the pipettor needle downward. When the needle gets close to waste /prime position, set stepsize smaller. Click the Clockwise direction  icon of outside arm, click the Counterclockwise direction  icon of outside arm, click the Clockwise direction  icon of inside arm, click the counterclockwise direction  icon of inside arm, adjust the Plane Position of Pipetting Needle.

Making the needle tip just above the waste /prime position. Then press  and  icon until the needle reaches the target position. Save the parameters with  icon.

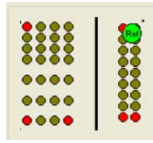
Requirements:

- 1 . The needle of the **waste position** must always be higher than the prime position wall. If the waste position is lower, the needle may crash when moving from the waste to the prime position.

2. The needle of the **Prime Position** should be taught to the bottom of the priming well and 3 steps up.

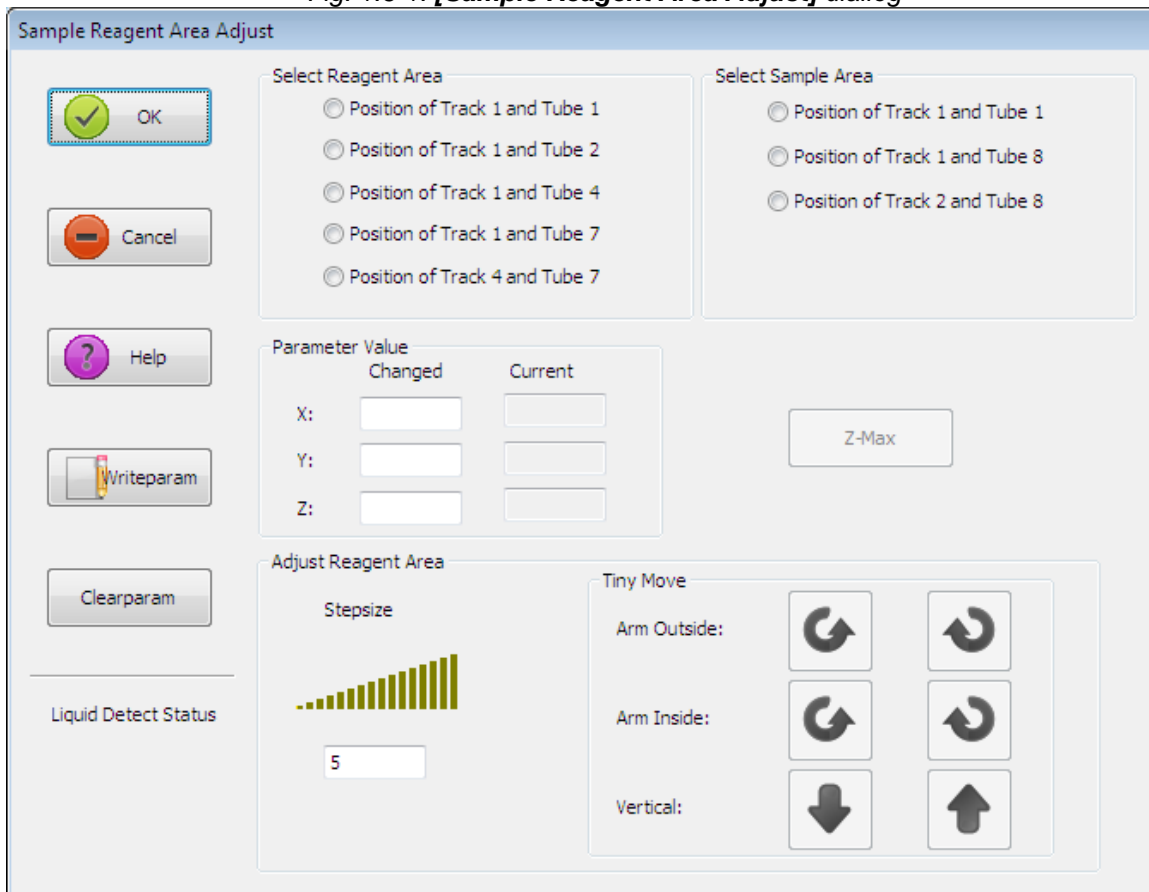


1.6 Sample Reagent area position adjust



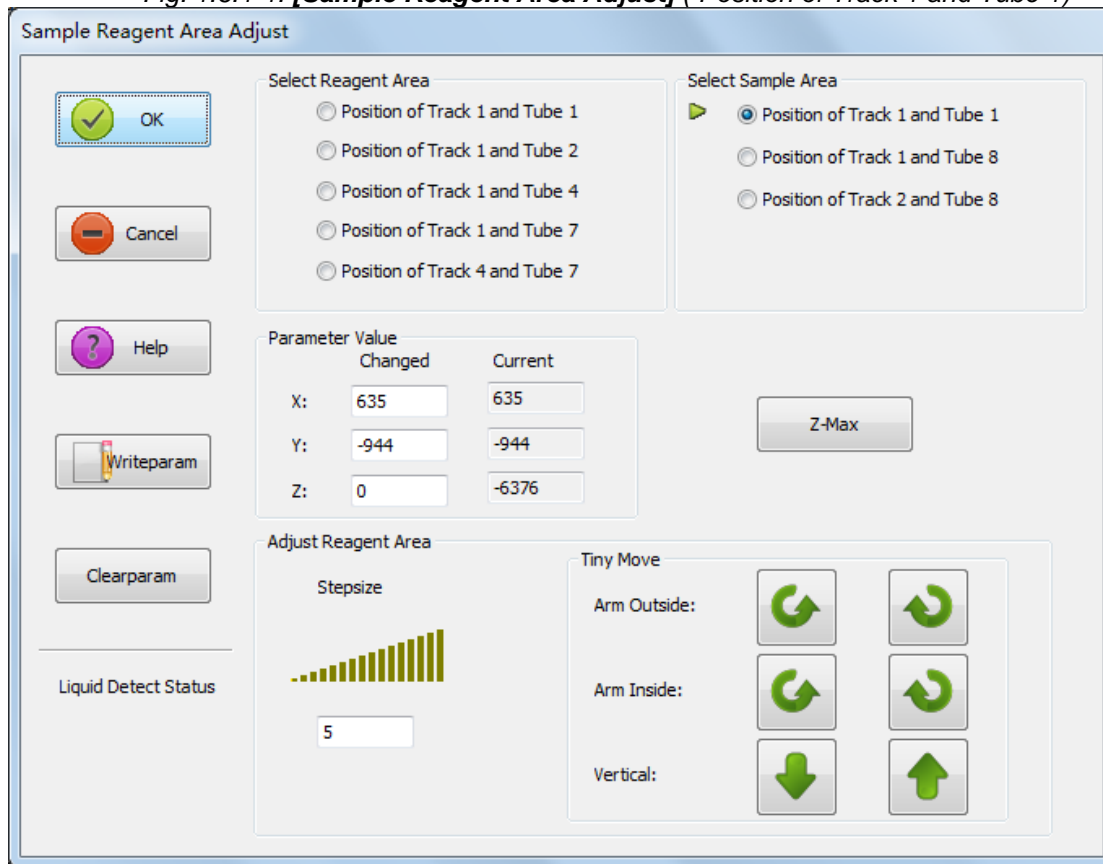
Click the icon in the [Needles Adjust] dialog to open the [Sample Area Reagent Adjust] dialog


Fig. 1.6-1: [Sample Reagent Area Adjust] dialog










1.6.1 Sample area position adjust




Select Position of Track 1 and Tube 1 in [SelectSample Area]
 Fig. 1.6.1-1: [Sample Reagent Area Adjust] (Position of Track 1 and Tube 1)



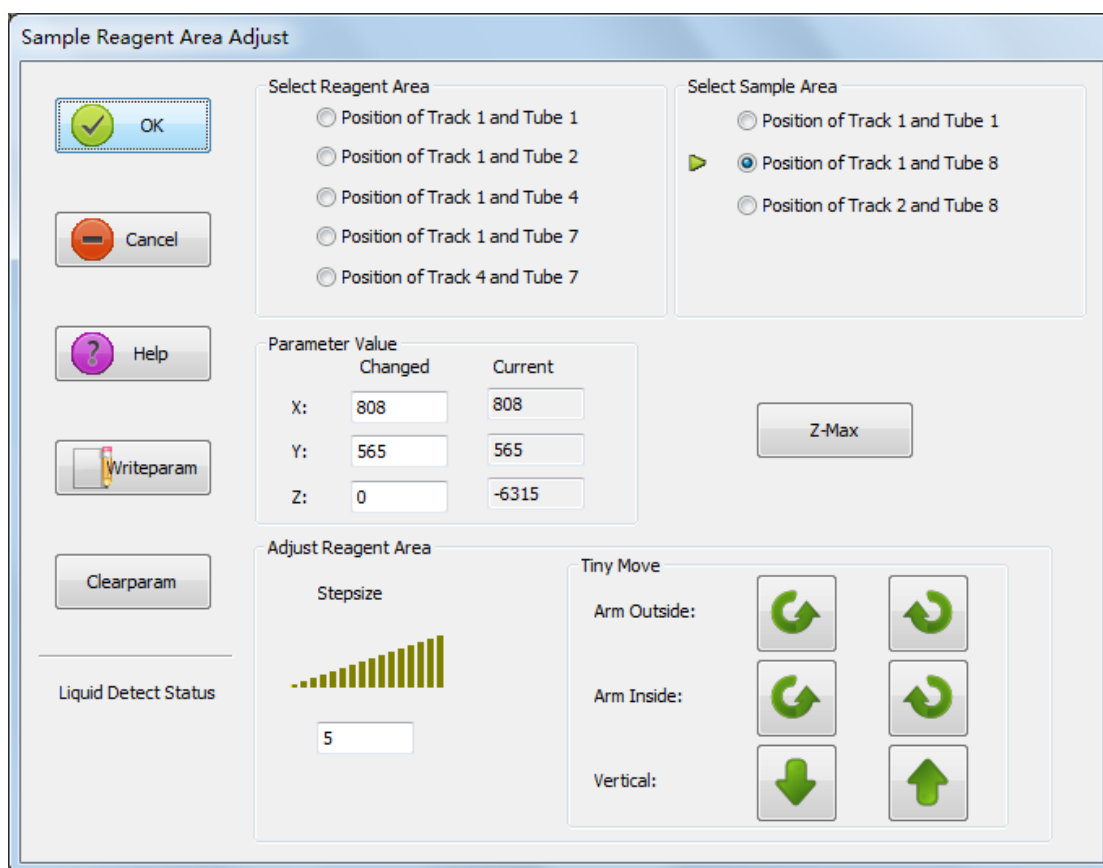
To set the stepsize-bar can adjust value of the stepsize. Set bigger stepsize firstly, click the icon  to downward the pipettor. When the pipettor get close to the reaction module, set stepsize smaller.

Then click the Clockwise direction  icon of outside arm, click the Counterclockwise direction  icon of outside arm, click the Clockwise direction  icon of inside arm, click the counterclockwise direction  icon of inside arm. Make the needle tip just above the target position, click upward  icon, downward  icon to make the needle tip reaches the Z_{max} in module. Save the parameters with  icon.


Reuirements:




1. The tube should be filled with 100 μ l water at first.
2. Plane position: needle's position should be just at the center point of the tube mouth.
3. Z_{max} in module: click  and  icon to adjust the pipettor needle. When the needle tip reaches the liquid level, the LLD' light would be on, then press  icon to save the parameters.
4. Press the $\langle Z_{max} \rangle$ icon while holding the "Shift" key on the keyboard, then the pipettor needle will move half the distance to Z_{max} . According to this method, the needle will gradually approach the Z_{max} in order to prevent the needle hitting the bottom of the tube.





Select Position of Track 1 and Tube 8 in [SelectSample Area]
 Fig. 1.6.1-2: [Sample Reagent Area Adjust] (Position of Track 1 and Tube 8)





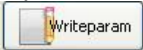
To set the stepsize-bar can adjust value of the stepsize. Set bigger

stepsize firstly,click the icon  to downward the pipettor. When the pipettor get close to the reaction module , set stepsize smaller.

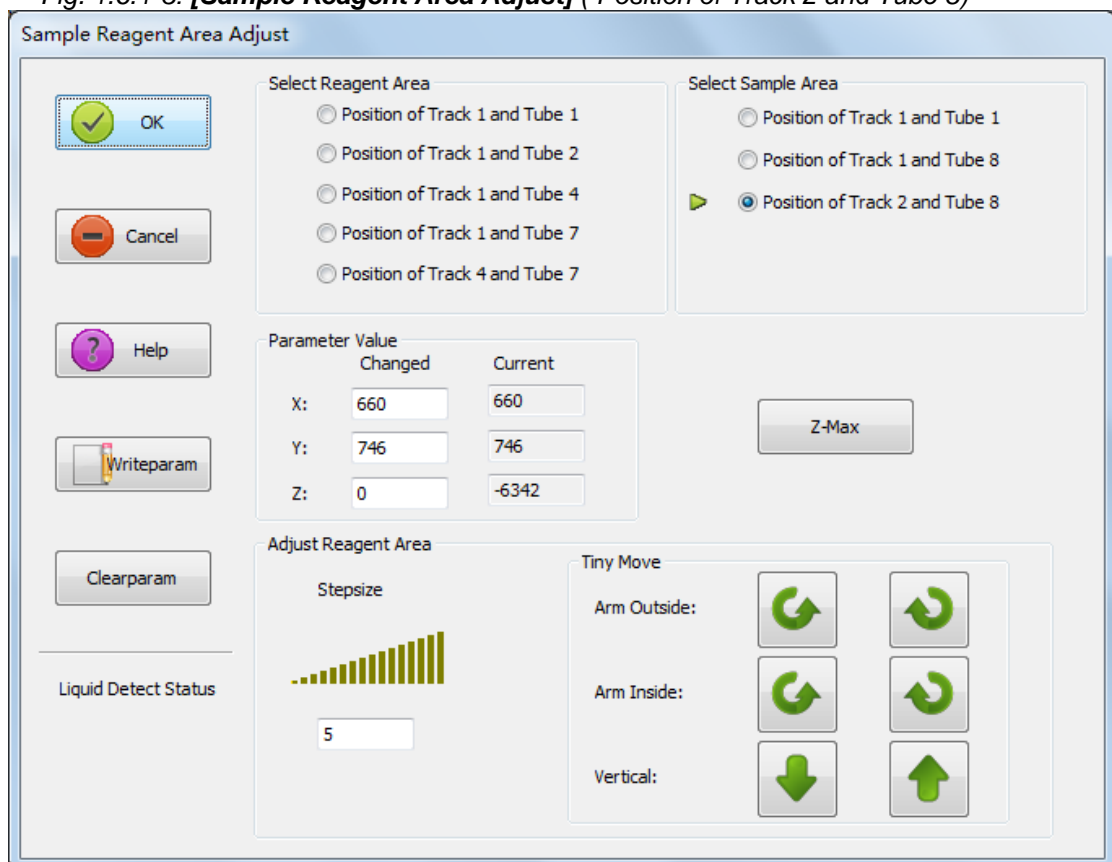
Then click the Clockwise direction  icon of outside arm, click the Counterclockwise direction  icon of outside arm, click the Clockwise direction  icon of inside arm , click the couterclockwise


direction  icon of inside arm. Make the needle tip just above the target position, click upward  icon, downward  icon to make the needle tip reaches the Z_{max} in module. Save the parameters with  icon.








Requirements:

1. The tube should be filled with 100 μ l water at first.
2. Plane position: needle's position should be just at the center point of the tube mouth.
3. Z_{max} in module: click  and  icon to adjust the pipettor needle. When the needle tip reaches the liquid level, the LLD' light would be on, then press  icon to save the parameters.
1. Press the $\langle Z_{max} \rangle$ icon while holding the "Shift" key on the keyboard, then the pipettor needle will move half the distance to Z_{max} . According to this method, the needle will gradually approach the Z_{max} in order to prevent the needle hitting the bottom of the tube.




Select Position of Track 2 and Tube 8 in [SelectSample Area]
 Fig. 1.6.1-3: [Sample Reagent Area Adjust] (Position of Track 2 and Tube 8)



To set the stepsize-bar can adjust value of the stepsize. Set bigger stepsize firstly, click the icon  to downward the pipettor. When the pipettor get close to the reaction module, set stepsize smaller.

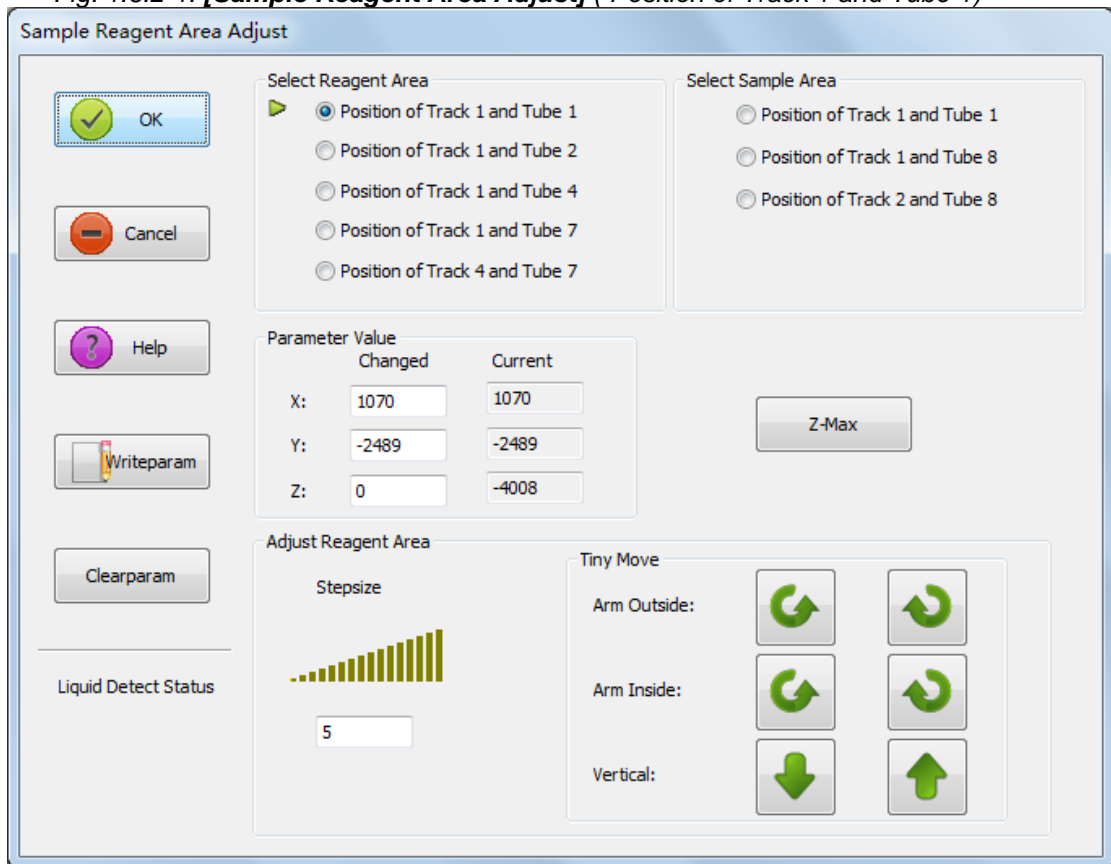
Then click the Clockwise direction  icon of outside arm, click the Counterclockwise direction  icon of outside arm, click the Clockwise direction  icon of inside arm, click the counterclockwise direction  icon of inside arm. Make the needle tip just above the target position, click upward  icon, downward  icon to make the needle tip reaches the Z_{max} in module. Save the parameters with  icon.


Reauirements:







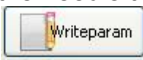
1. The tube should be filled with 100 μ l water at first.
 2. Plane position: needle's position should be just at the center point of the tube mouth.
 3. Z_{max} in module: click  and  icon to adjust the pipettor needle. When the needle tip reaches the liquid level, the LLD' light would be on, then press  icon to save the parameters.
1. Press the $\langle Z_{max} \rangle$ icon while holding the "Shift" key on the keyboard, then the pipettor needle will move half the distance to Z_{max} . According to this method, the needle will gradually approach the Z_{max} in order to prevent the needle hitting the bottom of the tube.

1.6.2 Reagent area position Adjust

Select Position of Track 1 and Tube 1 in [Select Reagent Area]
 Fig. 1.6.2-1: [Sample Reagent Area Adjust] (Position of Track 1 and Tube 1)






To set the stepsize-bar can adjust value of the stepsize. Set bigger stepsize firstly, click the icon  to downward the pipettor. When the pipettor get close to the reaction module, set stepsize smaller.

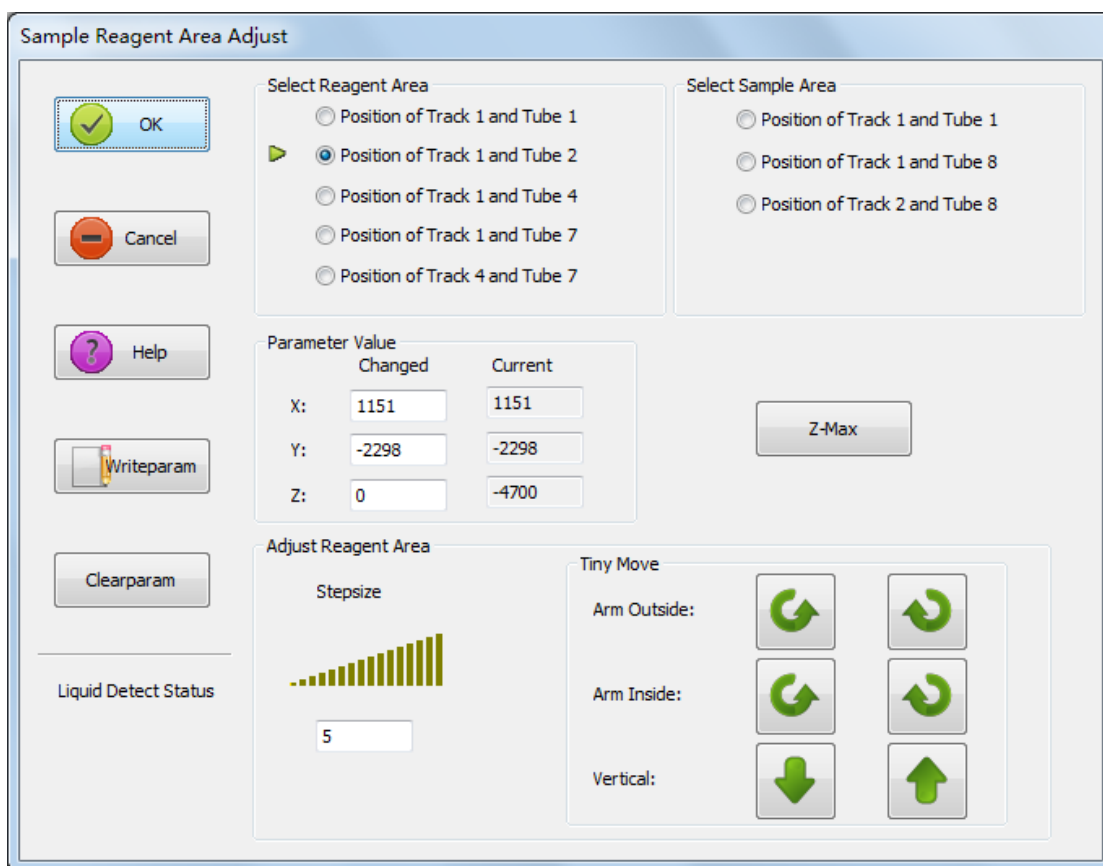
Then click the Clockwise direction  icon of outside arm, click the Counterclockwise direction  icon of outside arm, click the Clockwise direction  icon of inside arm, click the counterclockwise direction  icon of inside arm. Make the needle tip just above the target position, click upward  icon, downward  icon to make the needle tip reaches the Z_{max} in module. Save the parameters with  icon.








Reuirements:

1. Fill 200 μ l water into the 1st vial (the position of magnetic particle) of the reagent kit which is used for Coordinate.
2. Plane position: needle's position should be just at the center point of the sealing flap.

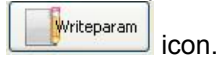
3. Z_{max} in module: click  and  icon to adjust the pipettor needle. When the needle tip reaches the liquid level, the LLD' light would be on, then click  icon to save the parameters.
4. Press the $\langle Z_{max} \rangle$ icon while holding the "Shift" key on the keyboard, then the pipettor needle will move half the distance to Z_{max} . According to this method, the needle will gradually approach the Z_{max} in order to prevent the needle hitting the bottom of the tube.

Select Position of Track 1 and Tube 2in [Select Reagent Area]
 Fig. 1.6.2-2: [Sample Reagent Area Adjust] (Position of Track 1 and Tube 2)



To set the stepsize-bar can adjust value of the stepsize. Set bigger stepsize firstly,click the icon  to downward the pipettor. When the pipettor get close to the reaction module , set stepsize smaller. Then click the Clockwise direction  icon of outside arm, click the Counterclockwise direction  icon of outside arm, click the Clockwise direction  icon of inside arm , click the couterclockwise direction  icon of inside arm. Make the needle tip just above the target position, click upward  icon, downward  icon to make

the needle tip reaches the Z_{max} in module. Save the parameters with

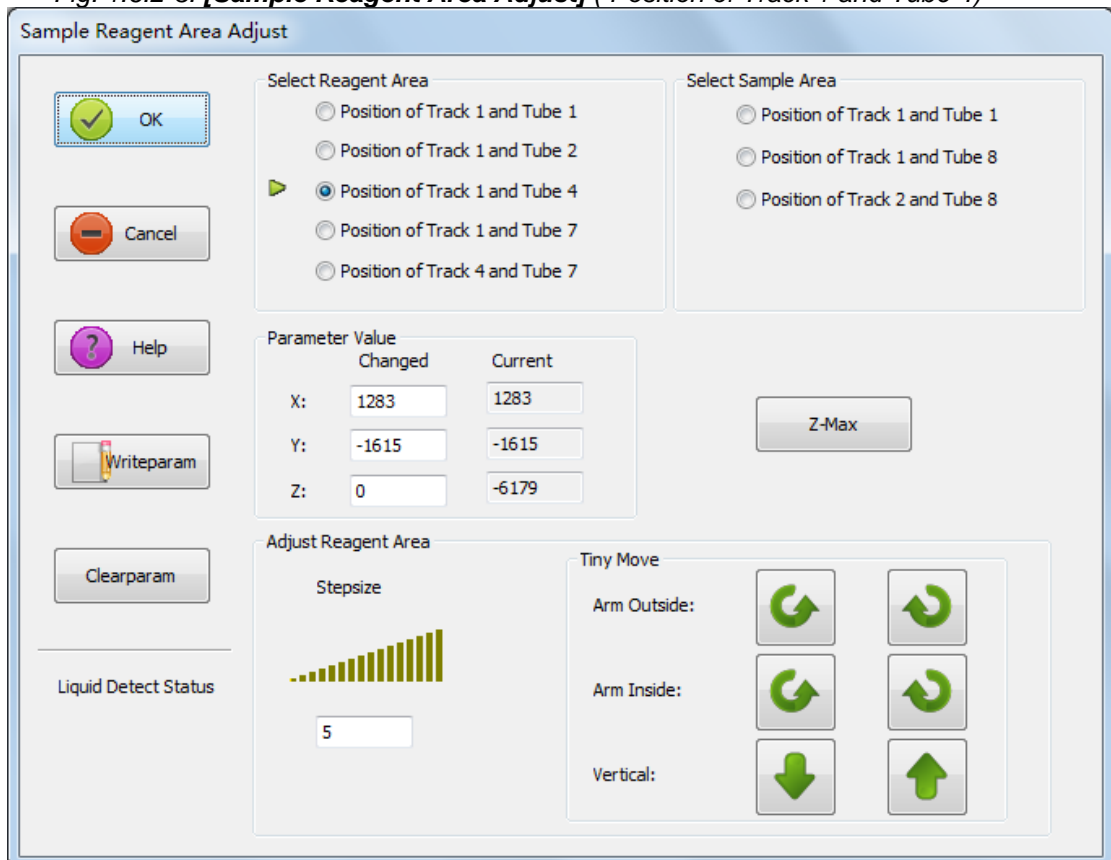



icon.








Reuirements:

1. Fill 200 μ l water into the 2nd vial (the position of low calibrator) of the reagent kit which is used for Coordinate.
2. Plane position: needle's position should be just at the center point of the sealing flap.
3. Z_{max} in module: click and icon to adjust the pipettor needle. When the needle tip reaches the liquid level, the LLD' light would be on, then click icon to save the parameters.
4. Press the $\langle Z_{max} \rangle$ icon while holding the "Shift" key on the keyboard, then the pipettor needle will move half the distance to Z_{max} . According to this method, the needle will gradually approach the Z_{max} in order to prevent the needle hitting the bottom of the tube.




Select Position of Track 1 and Tube 4in [Select Reagent Area]
 Fig. 1.6.2-3: [Sample Reagent Area Adjust] (Position of Track 1 and Tube 4)



To set the stepsize-bar can adjust value of the stepsize. Set bigger stepsize firstly, click the icon  to downward the pipettor. When the pipettor get close to the reaction module, set stepsize smaller.

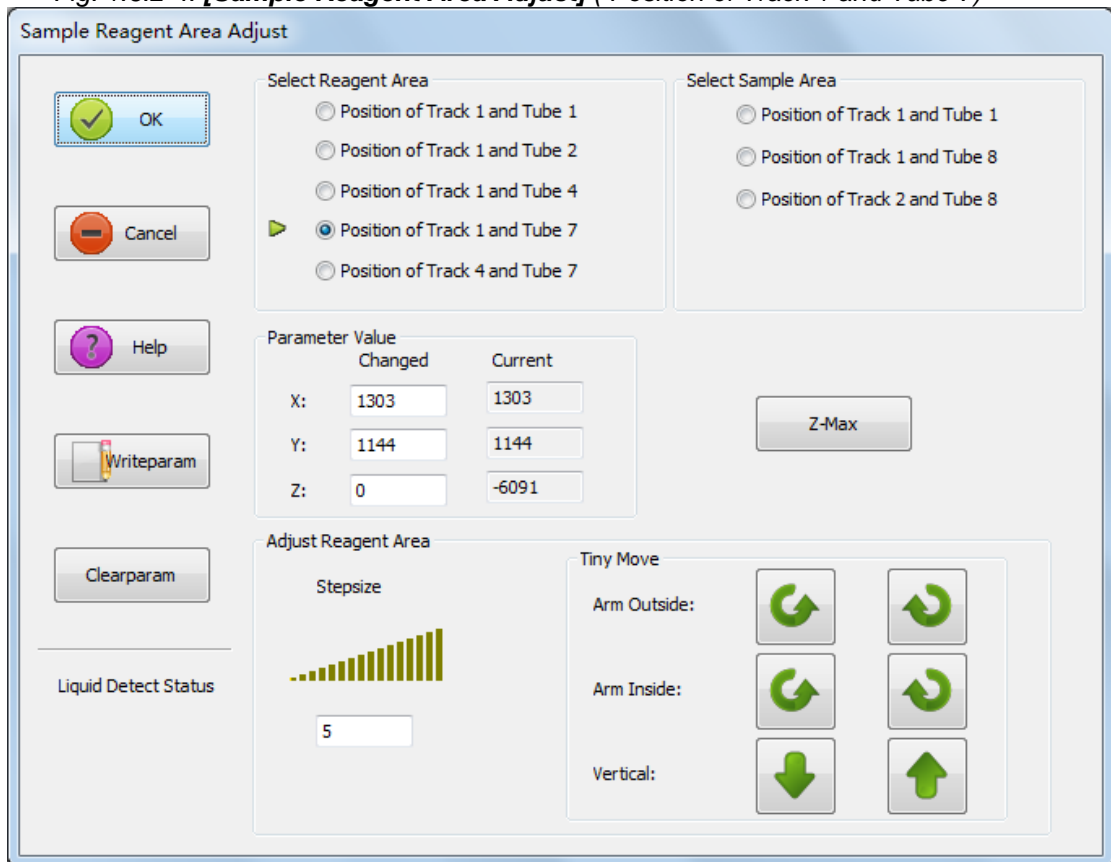
Then click the Clockwise direction  icon of outside arm, click the Counterclockwise direction  icon of outside arm, click the Clockwise direction  icon of inside arm, click the counterclockwise direction  icon of inside arm. Make the needle tip just above the target position, click upward  icon, downward  icon to make the needle tip reaches the Z_{max} in module. Save the parameters with  icon.


Reuirements:



1. Fill 500 μ l water into the 4th vial (the position of displacer) of the reagent kit which is used for Coordinate.
2. Plane position: needle's position should be just at the center point of the sealing flap.
3. Z_{max} in module: click  and  icon to adjust the pipettor needle. When the needle tip reaches the liquid level, the LLD' light would be on, then click  icon to save the parameters.
4. Press the $\langle Z_{max} \rangle$ icon while holding the "Shift" key on the keyboard, then the pipettor needle will move half the distance to Z_{max} . According to this method, the needle will gradually approach the Z_{max} in order to prevent the needle hitting the bottom of the tube.



Select Position of Track 1 and Tube 7 in [Select Reagent Area]



Fig. 1.6.2-4: [Sample Reagent Area Adjust] (Position of Track 1 and Tube 7)




To set the stepsize-bar can adjust value of the stepsize. Set bigger stepsize firstly, click the icon  to downward the pipettor. When the pipettor get close to the reaction module, set stepsize smaller.




Then click the Clockwise direction  icon of outside arm, click the Counterclockwise direction  icon of outside arm, click the

Clockwise direction  icon of inside arm, click the counterclockwise direction  icon of inside arm. Make the needle tip just above the

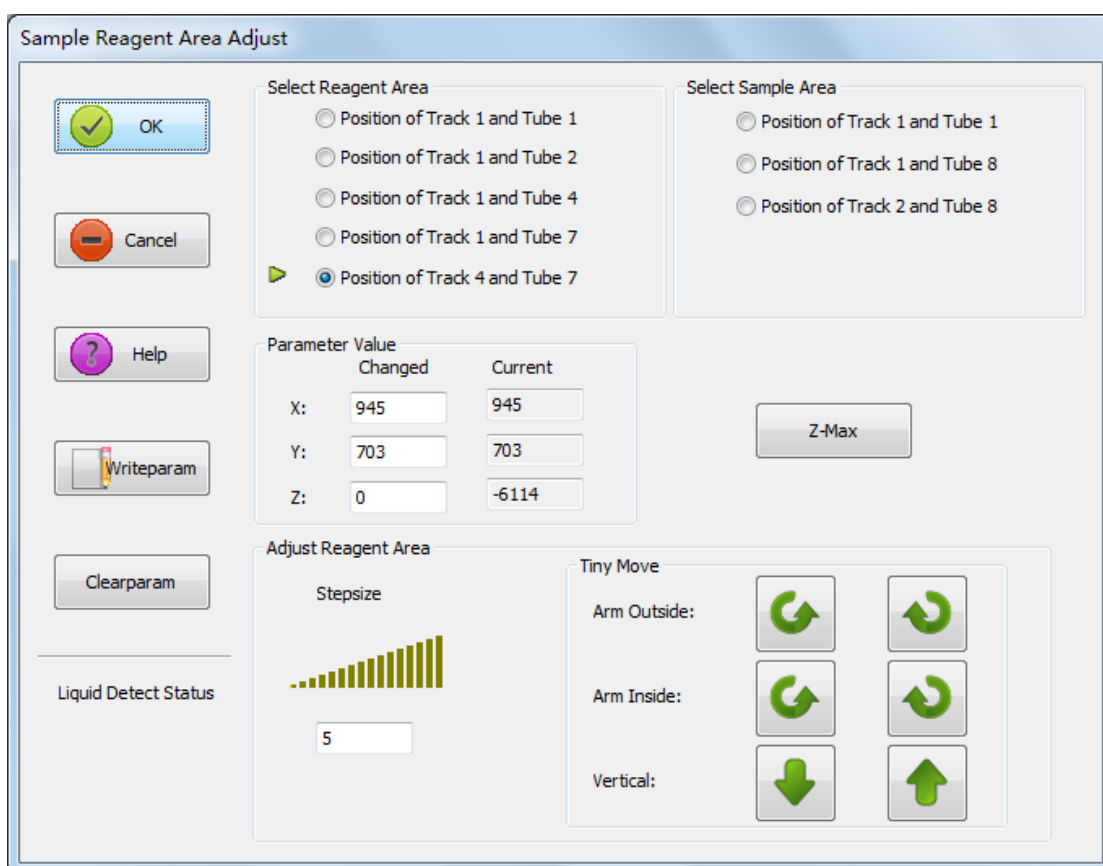
target position, click upward  icon, downward  icon to make the needle tip reaches the Z_{max} in module. Save the parameters with


 icon.



Reuirements:






1. Fill 1000 μ l water into the 7th vial (the position of diluter) of the reagent kit which is used for Coordinate.
2. Plane position: needle's position should be just at the center point of the sealing flap.
3. Z_{max} in module: click  and  icon to adjust the pipettor needle. When the needle tip reaches the liquid level, the LLD' light would be on, then click  icon to save the parameters.
4. Press the $\langle Z_{max} \rangle$ icon while holding the "Shift" key on the keyboard, then the pipettor needle will move half the distance to Z_{max} . According to this method, the needle will gradually approach the Z_{max} in order to prevent the needle hitting the bottom of the tube

Select Position of Track 4 and Tube 7in [Select Reagent Area]
 Fig. 1.6.2-5: [Sample Reagent Area Adjust] (Position of Track 4 and Tube 7)






To set the stepsize-bar can adjust value of the stepsize. Set bigger stepsize firstly,click the icon  to downward the pipettor. When the pipettor get close to the reaction module , set stepsize smaller.

Then click the Clockwise direction  icon of outside arm, click the Counterclockwise direction  icon of outside arm, click the

Clockwise direction  icon of inside arm , click the counterclockwise direction  icon of inside arm. Make the needle tip just above the target position, click upward  icon, downward  icon to make the needle tip reaches the Z_{max} in module. Save the parameters with  icon.

Reuirements:

1. Fill 1000 μ l water into the 7th vial (the position of diluter) of the reagent kit which is used for Coordinate.
2. Plane position: needle's position should be just at the center point of the sealing flap.
3. Z_{max} in module: click  and  icon to adjust the pipettor needle. When the needle tip reaches the liquid level, the LLD' light would be on, then click  icon to save the parameters.
4. Press the $\langle Z_{max} \rangle$ icon while holding the "Shift" key on the keyboard, then the pipettor needle will move half the distance to Z_{max} . According to this method, the needle will gradually approach the Z_{max} in order to prevent the needle hitting the bottom of the tube
5. When the adjustment finishes, take out of the reagent kit which is used for coordinate and then slide it into the fifteenth track of Reagent Area

1.7 Z-Dispense position adjust

Fill 600µl water into module's position 1 and then insert it in the the slot 1 of Incubator position.

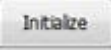
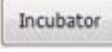

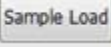


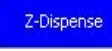
1. Click  icon in **[maglumi 600 service] interface**, after finished initialize. Click  icon to open **[Incubator] dialog**. Select Backtransport Position in the field of **[Target Position]** (Fig.1.7-2) , and then click  icon, back to **[Maglumi Service] dialog**
2. Click  icon to open **[Sample Loader] dialog**. Select Both in the field of **[Target Position]** (Fig.1.7-3) , and then click  icon, back to **[Maglumi Service] dialog**
3. Click the upper left corner  button of **[Maglumi 600 Service] interface** to open **[Needles Adjust] dialog**, click  icon to open **Dispense Adjust] dialog** (Fig.1.7-4)

Fig .1.7-1 Liquid level of the ReactionModule

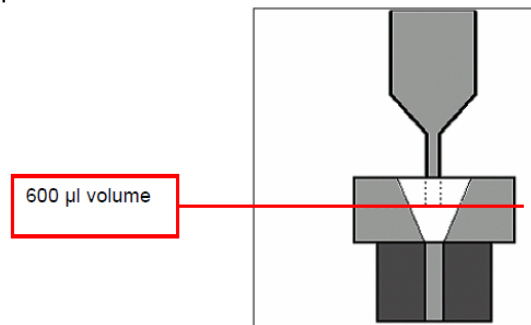


Fig.1.7-2: [Incubator] dialog

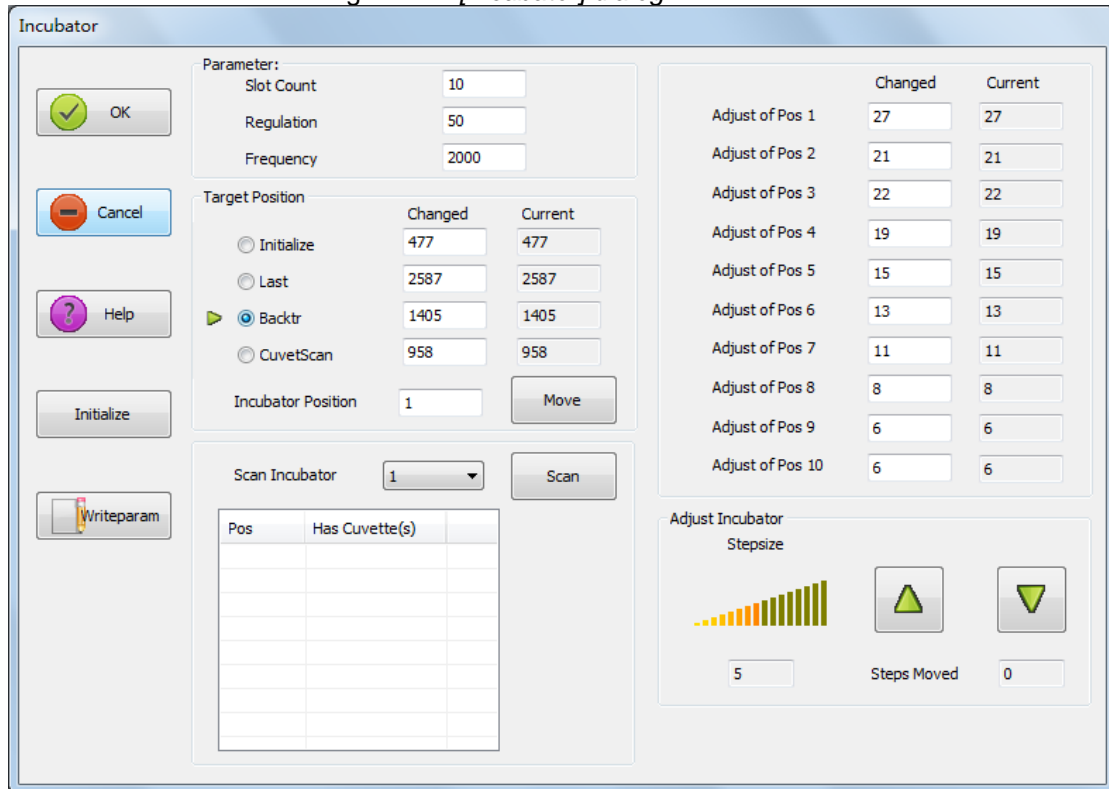


Fig.1.7-3 : [Sample Loader] dialog

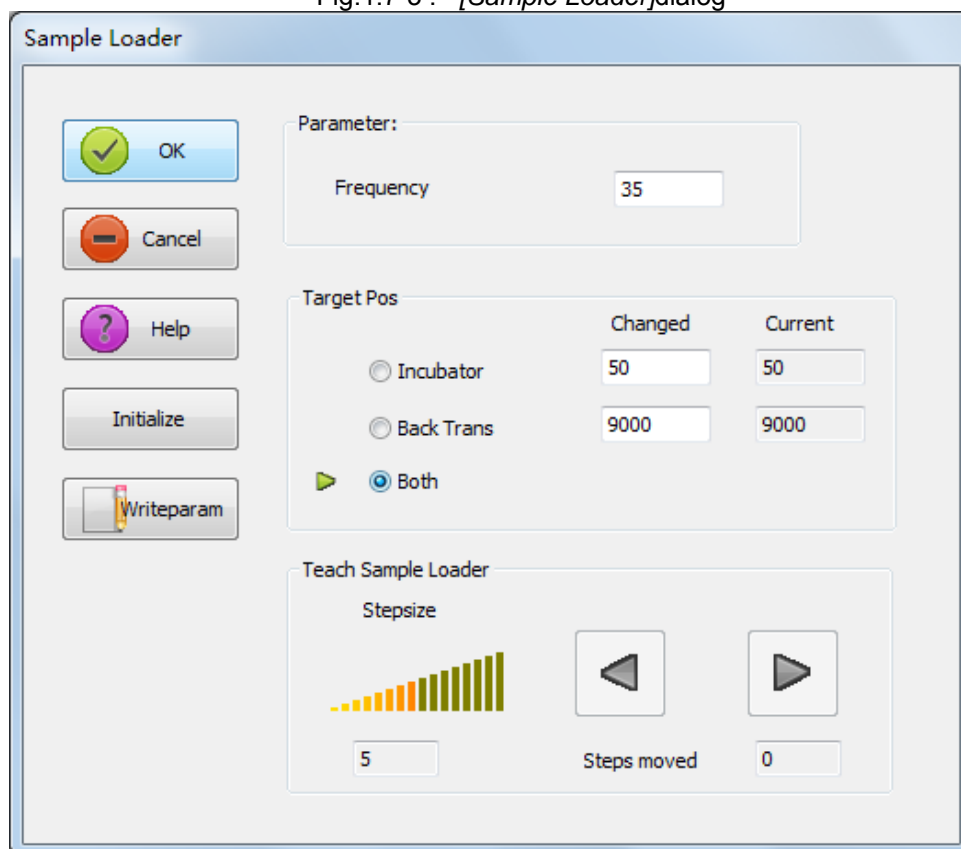
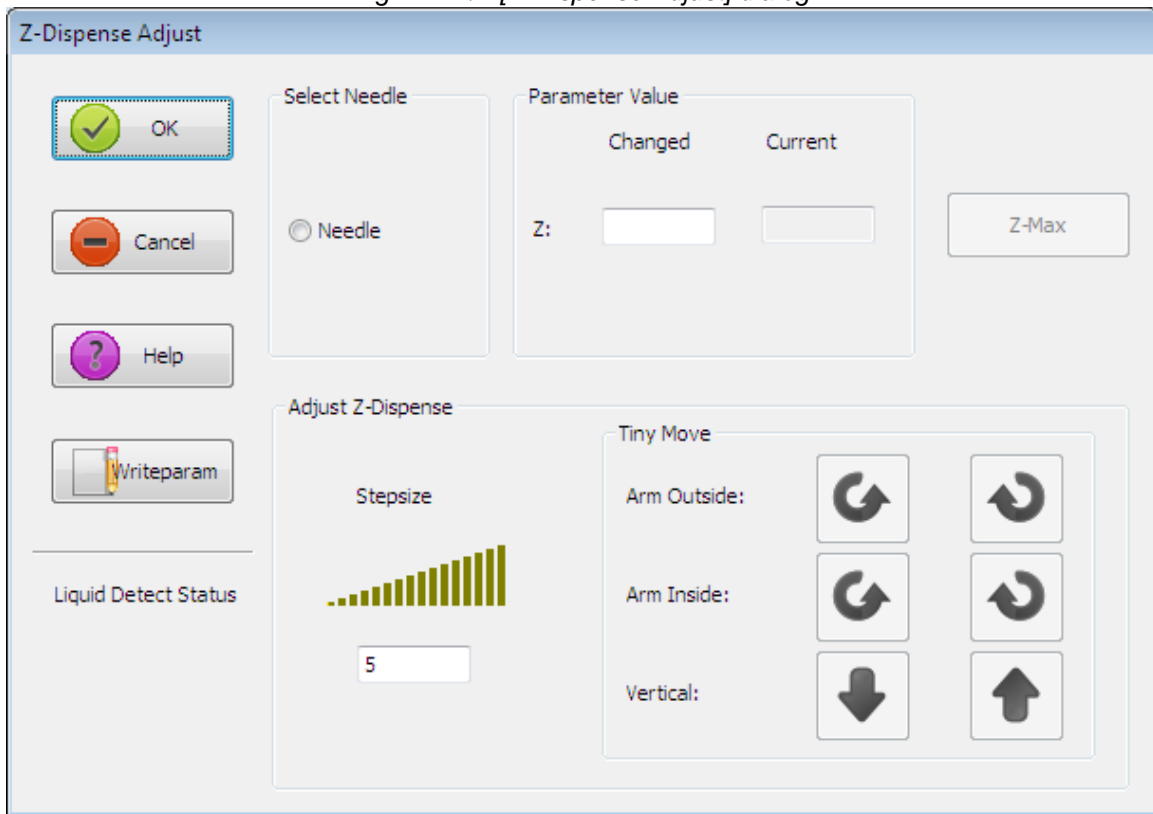
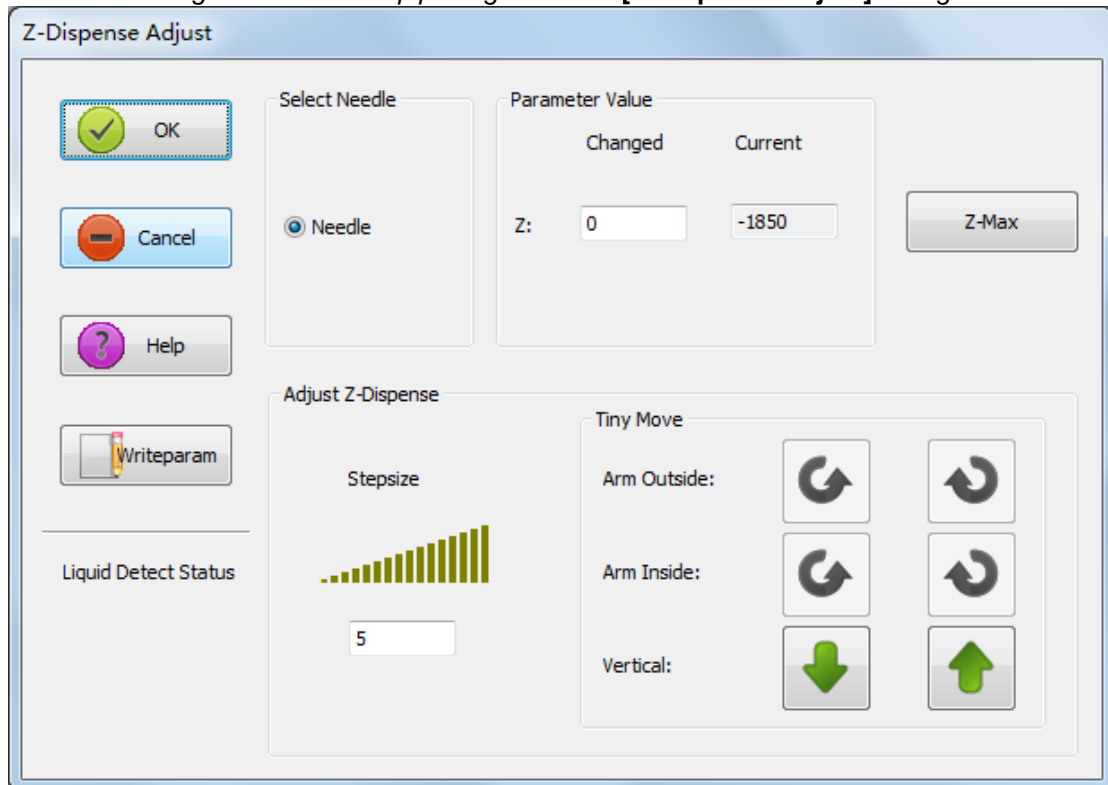





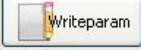
Fig .1.7-4: [Z-Dispense Adjust] dialog



Select Needle in [Select Needle]

Fig .1.7-5: Select pipetting needle in [Z-Dispense Adjust] dialog



To set the stepsize-bar can adjust value of the stepsize. Set bigger stepsize firstly,click the icon  to downward the pipettor. When the pipettor get close to the reaction module , set stepsize smaller. Click  and  icon to adjust the pipettor needle. When the needle tip reaches the liquid level, the LLD' light would be on, then click  icon to save the parameters.

1.8 Adjustment of the pipetting needle in Z- Start position

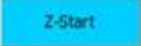
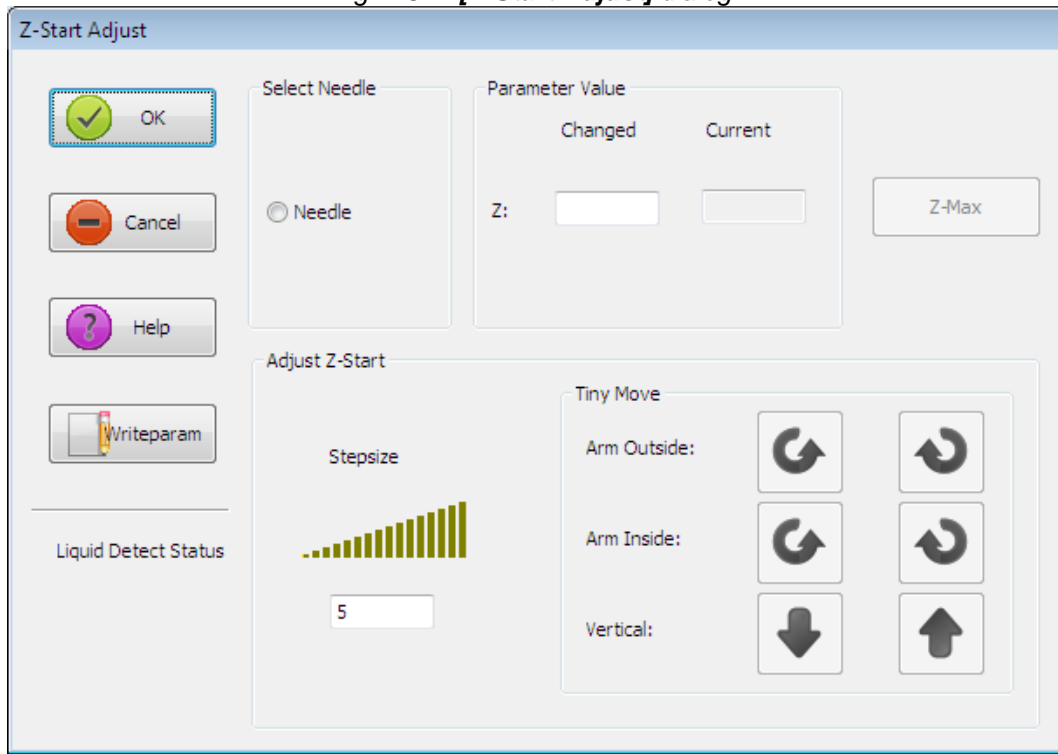
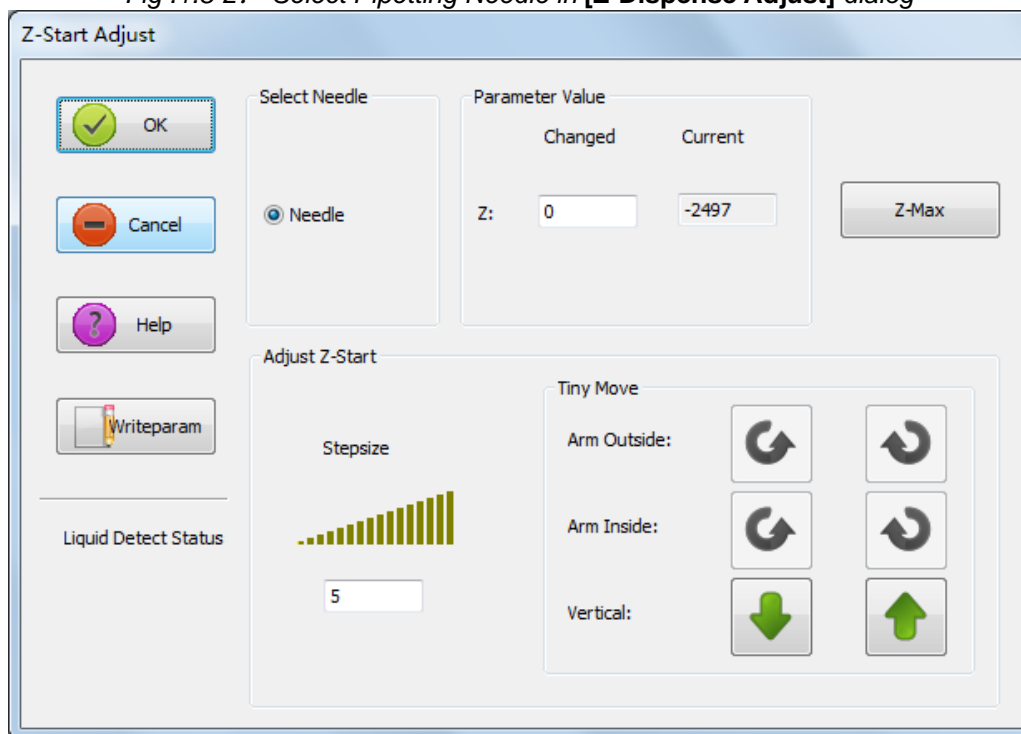
Click  icon to open[Z-Start Adjust] dialog
 Select Needle in [Select Needle]



Fig. 1.8-1: [Z-Start Adjust] dialog.



Select Needle in [Select Needle]

Fig .1.8-2: Select Pipetting Needle in [Z-Dispense Adjust] dialog



To set the stepsize-bar can adjust value of the stepsize. Press  icon to move the pipettor needle downward. When 2/3 of the needle tip coated with Teflon just cross the sealing flap to the 1st vial mouth of the reagent kit, press  icon to save the parameters.

When the coordinates finishes, press the <OK> button in the **[Needles Adjust]** dialog to exit.

Remove the tubes, reaction modules and reagent kit used for coordinate from the analyzer and then transmit a new reaction module to the left pipetting position.

Appendix B

Software Upgrade

- 1.1 Operating Software Upgrade 2
 - 1.1.1 Kernel or structure of operating software upgrade 2
 - 1.1.2 Operating software patch update 7
- 1.2 Master control PCB Programs' Upgrade 8
 - 1.2.1 M600-01-E00-COP or M800-01-E00-COP write the flash out of the upgrade program 8
 - 1.2.2 M600- 02~04 board or M800-02~05 program upgrade writing flash out 12

1.1 Operating Software Upgrade

In order to constantly improve operating software of MALGUMI series automatic chemiluminescence analyzer, it is necessary to upgrade it.

Upgrade mode includes:

- 1) Install new version of the operating software,
- 2) Upgrade some small patch of software.

This chapter will introduce the general procedure of software upgrade. We have the special Guidance document for every specific software upgrade

1.1.1 Kernel or structure of operating software upgrade

When the Kernel or structure of operating software changes, the analyzer need to be upgraded to a new version.

The new version of the operating software will be sent to you by email or by CD. And backup the previous operating software.

Upgrade steps:

- 1) Backup four important folders in "C:\program files\Maglumi 600", including assay, component, report, config
- 2) Uninstall the old version, then install the new version.
- 3) Copy the four important folders to cover in the new version of software.
- 4) Restart the computer system.
- 5) Turn on the analyzer, run SERVICE.EXE software to detect and re-adjust the position of pipetting needle. After that exit the dialog.
- 6) Run Priming, BGW and LC to ensure the status of the analyzer.
- 7) Suggest that run Two Step Assay once, confirm the result in target range, unsure analyzer upgrade successfully.

The installation process of the specific steps please see pictures below:

Fig .1.1.1-1: MAGLUMI®600 MAGLUMI Users operating software installation process1



Fig .1.1.1-2: MAGLUMI®600 MAGLUMI Users operating software installation process2

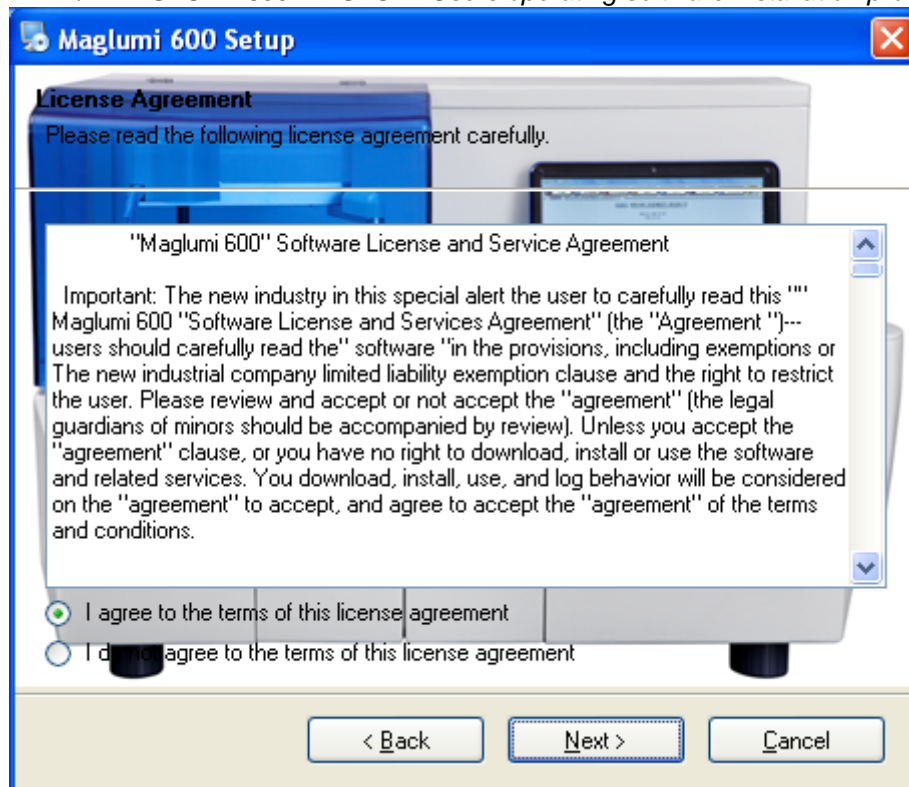


Fig .1.1.1-3: MAGLUMI®600 MAGLUMI Users operating software installation process3

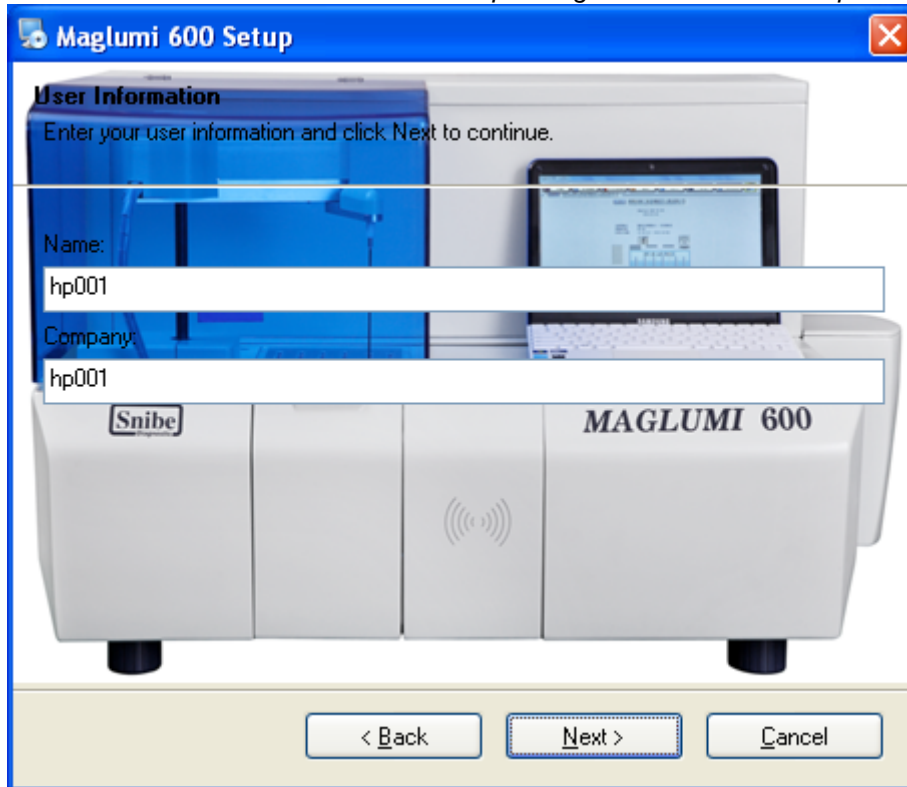


Fig .1.1.1-4: MAGLUMI®600 MAGLUMI Users operating software installation process4

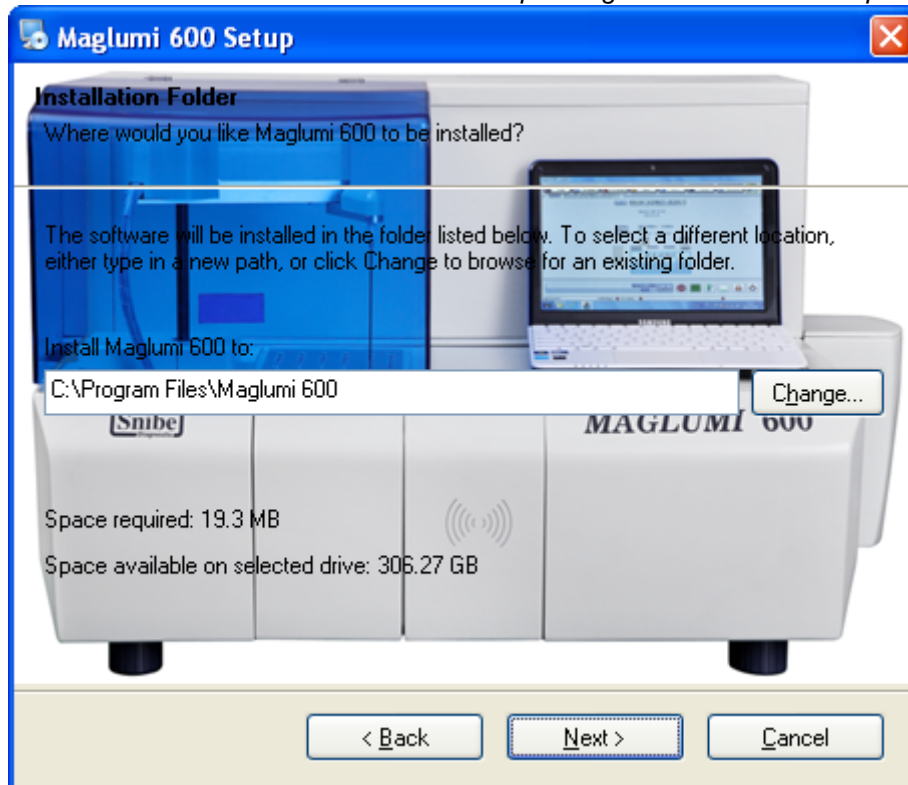


Fig .1.1.1-5: MAGLUMI®600 MAGLUMI Users operating software installation process5

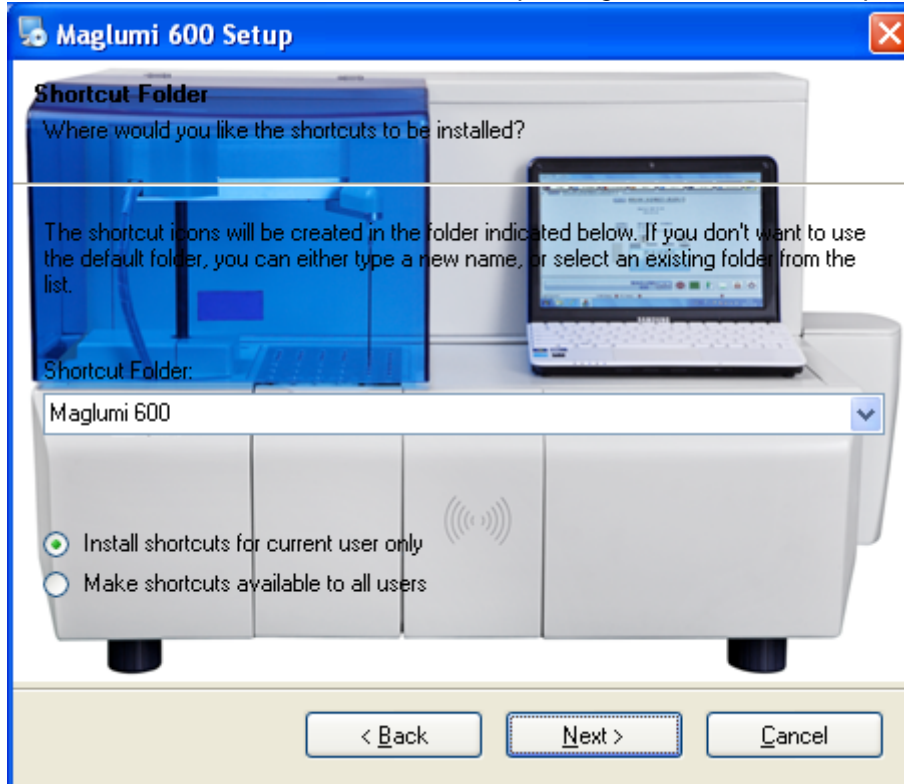


Fig .1.1.1-6: MAGLUMI®600 MAGLUMI Users operating software installation process6

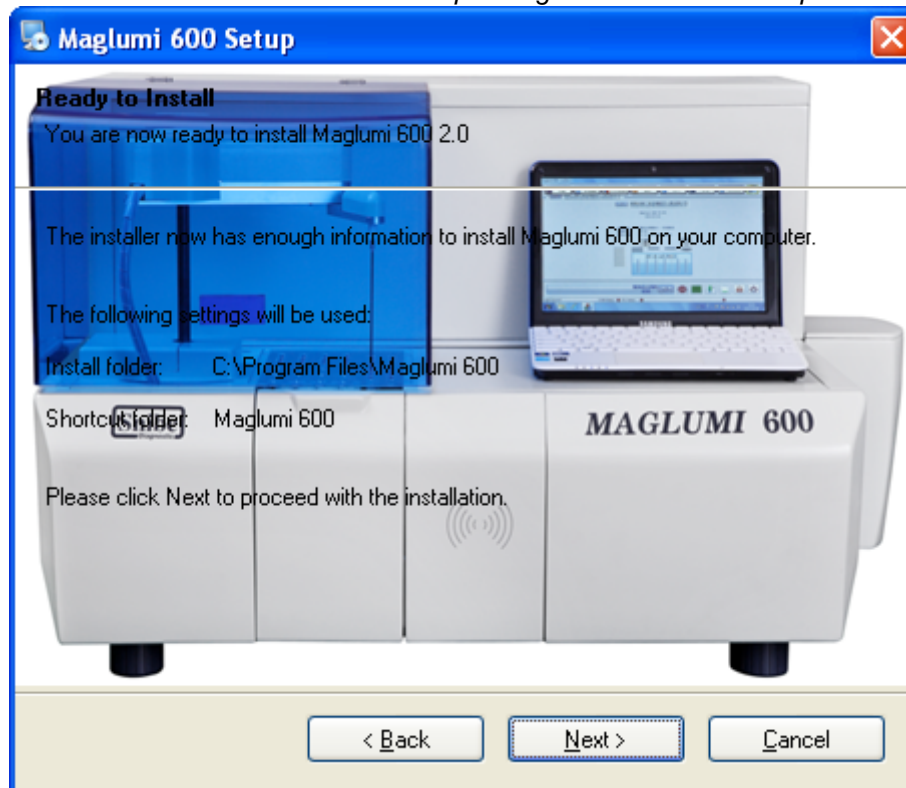


Fig .1.1.1-7: MAGLUMI®600 MAGLUMI Users operating software installation process7

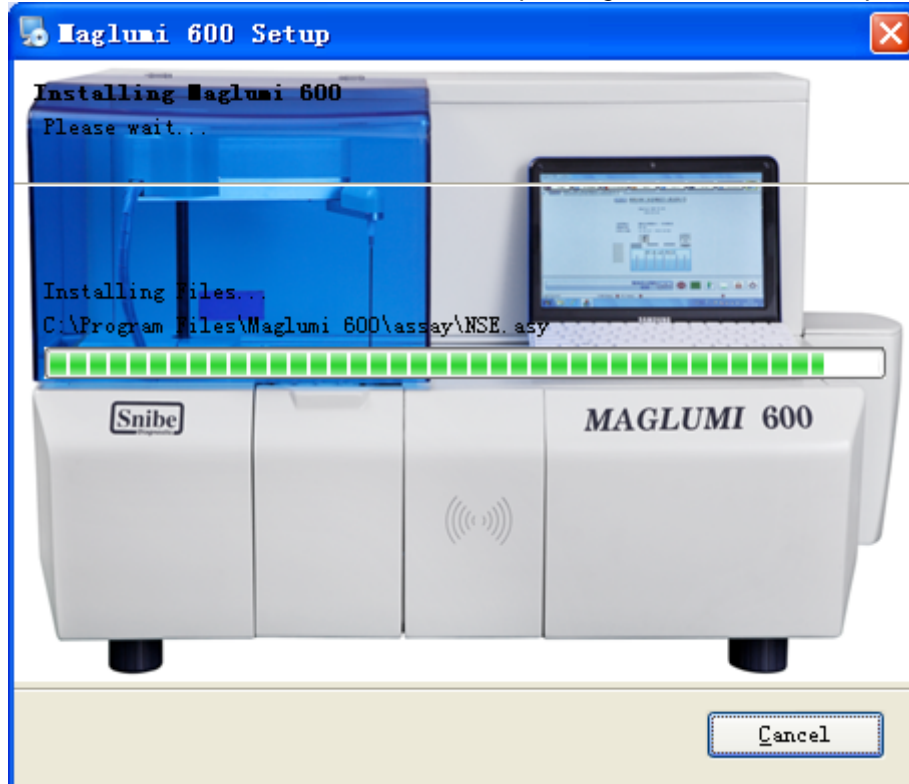
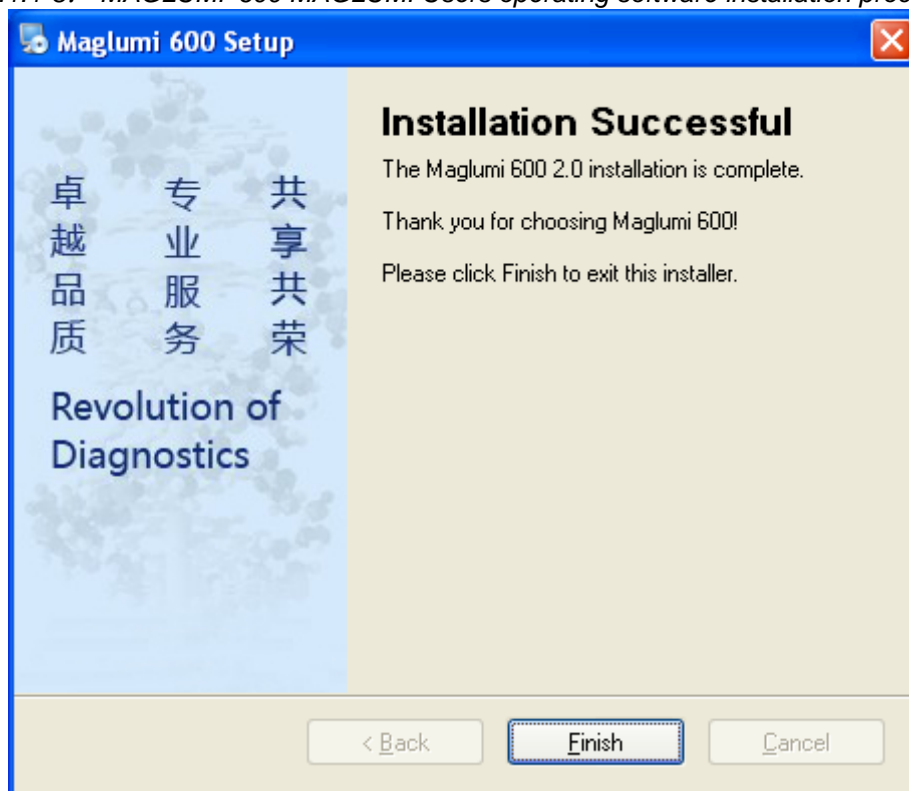


Fig .1.1.1-8: MAGLUMI®600 MAGLUMI Users operating software installation process8



1.1.2 Operating software patch update

Sometimes, the system software only need to be upgraded for a small function or do some small change, you needn't uninstall the old version and install the new version.

You only need to copy the upgrade files and then cover these files in the "C:/Program files/Maglumi600". If there are more steps to do, it will be mention in the"upgrade instruction"

1.2 Master control PCB Programs' Upgrade

Each component of analyzer has been controlled by corresponding PCB board. The controlling circuit has data line interface for upgrade.

For Maglumi 600, there are 4 pieces of master control PCB boards on the analyzer can be upgraded, they control components respectively, their numbers and names are :

- a) M600-01-E00-COP
- b) M600-02-E00-Sample&Reagent
- c) M600-03-E00-Incubator&Washer&Pusher
- d) M600-04-E00-MeasureChamber

PCB board schematic diagram

4 pieces of master control PCB board should be upgraded by two different methods.

Method 1: M600-01 - E00 - COP can be upgraded program by the RS232 directly.

Method 2: M600-02 - E00, M600-03-E00 and M600-04-E00 board should be upgraded by special upgrading cable.

For Maglumi 800, there are 5 pieces of master control PCB boards on the analyzer can be upgraded, they control components respectively, their numbers and names are :

- a) M800-01-E00-COP
- b) M800-02-E00-Sample Arm
- c) M800-03-E00-Washer
- d) M800-04-E00-MeasureChamber(it is same as M600-04-E00-MeasureChamber)
- e) M800-05-E00-Multiple Modules

PCB board schematic diagram

5 pieces of master control PCB board should be upgraded by two different methods.

Method 1: M800-01 - E00 - COP can be upgraded program by the RS232 directly.

Method 2: M600-02 - E00, M600-03-E00, M600-04-E00 and M600-05-E00 board should be upgraded by special upgrading cable.

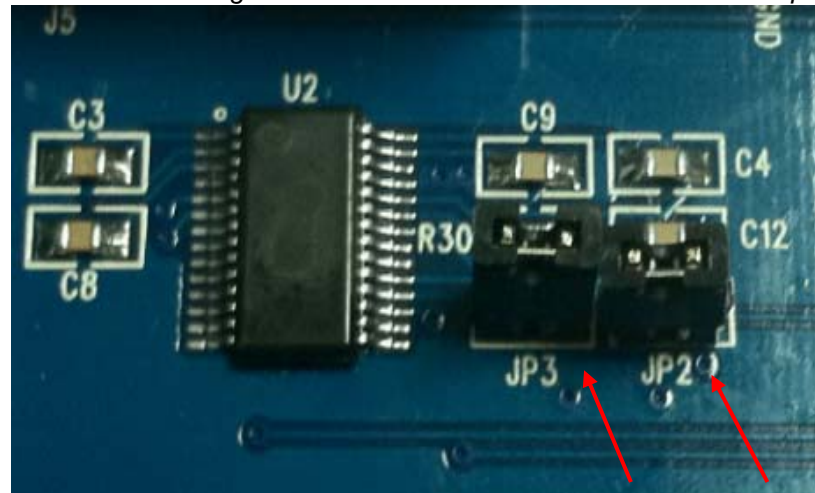
1.2.1 M600-01-E00-COP or M800-01-E00-COP write the flash out of the upgrade program

Upgrade Procedure

1) Before upgraded, connect USB Port of computer to RS232 Interface of analyzer with RS232 data line

2) Take 01- E00- COP out under shutdown condition, then connect J2 and J3 jumper wire cap see diagram below:

Fig .1.2.1-1: Position of 01-E00-COP Board Jumper



3) Restart the computer and analyzer. Operate Flash Magic exe on computer. Then select options as follows



Step 1 - Communications:

step	option	content	meaning
1	Device	LPC2468	write the flash out of chip
2	COM Port	COM1	Communication port
3	Baud Rate	115200	write the flash out of speed
4	Oscillator(MHz)	14.31818	Frequency (fixed)

Step 2 - Erase:

step	option	content	meaning
1	Erase all Flash+Code Rd Prot	√	Remove all flash and codes

Step 3 - Hex File:

step	option	content	meaning
1	Hex Filehex document	select document written the flash out (COP.hex), provided by SNIBE

Step 4 - Option:

step	option	content	meaning
1	Verify after programming	√	Proofread after writing flash out

Completing to set the four major steps as above, as shown in the diagram below

Fig .1.2.1-2: Upgrade procedure of MAGLUM[®] 600/800 master control PCB board M600-01-E00-COP or M800-01-E00-COP

The screenshot shows a software upgrade dialog box with three main sections:

- Step 1 - Communications:** Device: LPC2468, Baud Rate: 115200, COM Port: COM1, Oscillator(KHz): 14318.18.
- Step 2 - Hex File:** Hex File: F:\cop.hex, with a Browse.. button.
- Step 3 - Operation:** Contains Start and Exit buttons.

A yellow callout box with a red arrow points to the Start button, containing the text: "Press Start button to execute".

Step 5 - Start!:

Press the "start" button, software will start to write program into the CMOS chip .
After that, Software will display "finished" at left bottom.

Fig .1.2.1-3: dialog of finished software upgrade

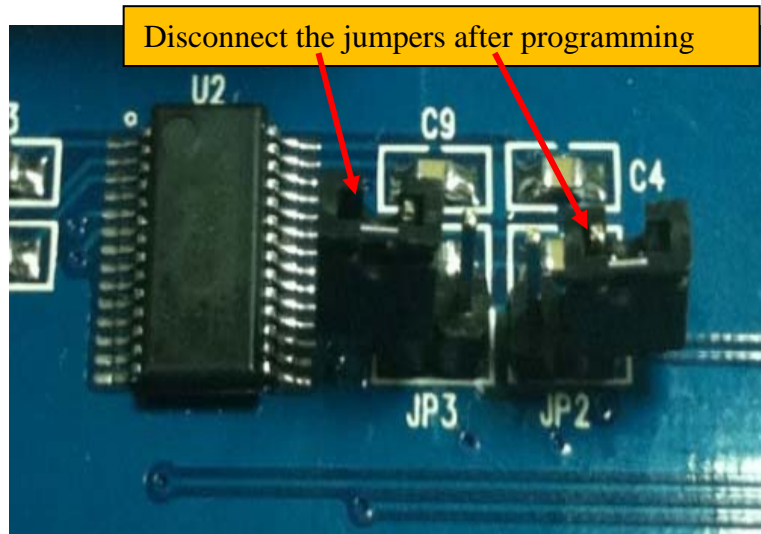
The screenshot shows the same software upgrade dialog box as in Fig. 1.2.1-2, but with the following changes:


- Step 1 - Communications:** Device: LPC2132, Baud Rate: 115200, COM Port: COM1, Oscillator(KHz): 14318.18.
- Step 2 - Hex File:** Hex File: F:\cop.hex, with a Browse.. button.
- Step 3 - Operation:** Contains Start and Exit buttons. The Start button is now disabled (greyed out).

At the bottom left of the dialog, the text "Download Success!" is displayed.

Step 6:

after writing flash out the COP program, make sure to pull jumper wire cap out (must operate under the consideration of interruption of power supply of analyzer), can hang on one foot of J2, J3, such as



	<p><i>If connect COP jumpers wire cap at the runtime, may cause the COP programs and data loss, cannot continue to do the experiment.</i></p>
--	--

1.2.2 M600- 02~04 board or M800-02~05 program upgrade writing flash out

Upgrade procedure:

- 1) Before upgrade, turn off power supply. Use RS232 interface data line provided by company, program download line connect (shown as below) to computer COM ports and analyzer 02-04 master board program download interface, program download line and connections method as below shown

Fig. 1.2.2-1: MAGLUMI600 analyzer master board 02-04, program download line



Fig. 1.2.2-2: MAGLUMI600 analyzer master board 02 program download interface: J4

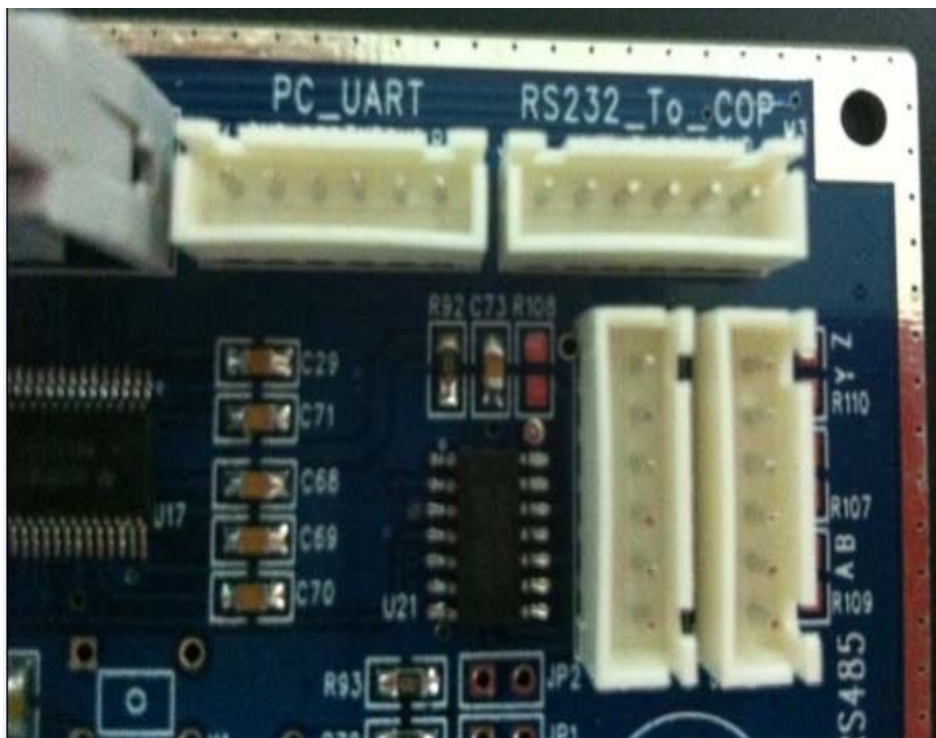


Fig. 1.2.2-3: MAGLUMI600 analyzer master board 03program download interface: J4



Fig. 1.2.2-4: MAGLUMI600 analyzer master board 04program download interface: J7



Fig. 1.2.2-5: MAGLUMI800 analyzer master board 02 program download interface: J4

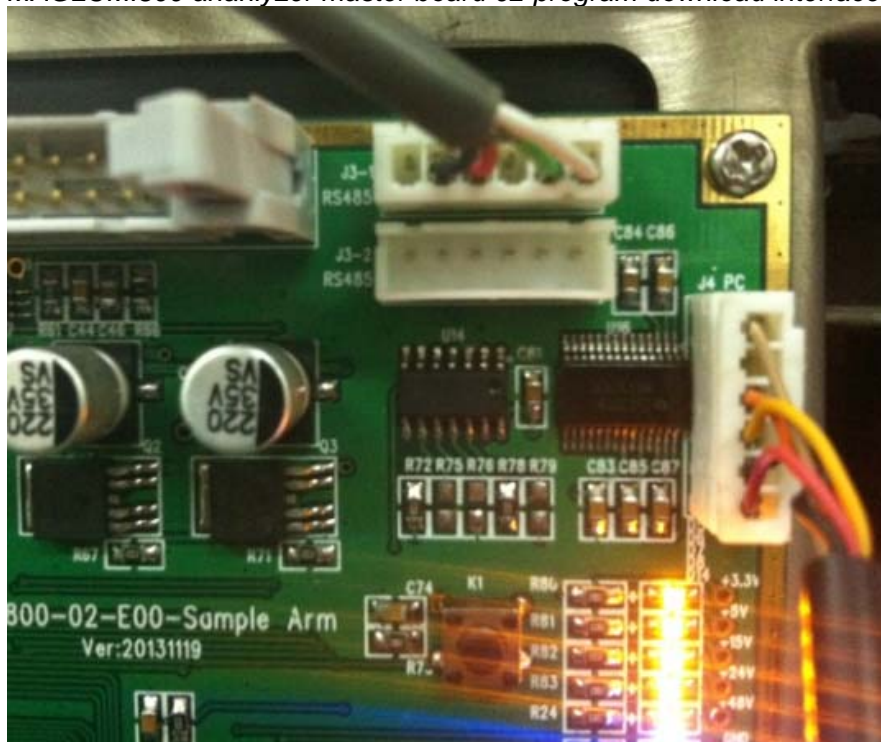


Fig. 1.2.2-6: MAGLUMI800 analyzer master board 03 program download interface: J7

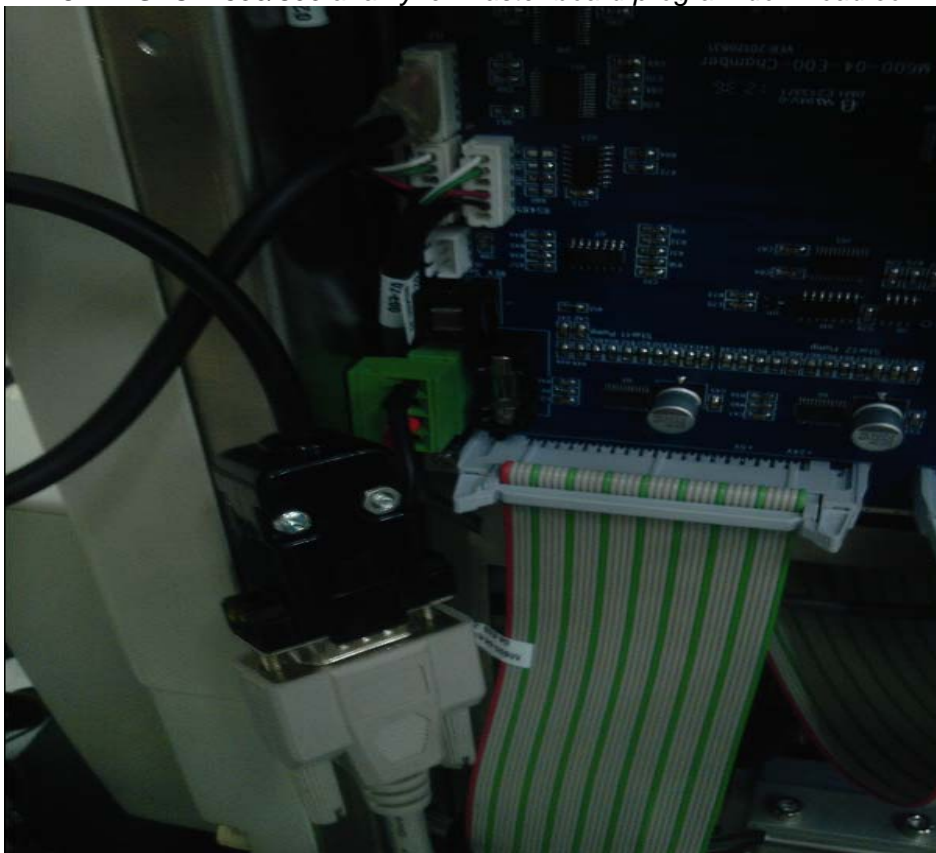


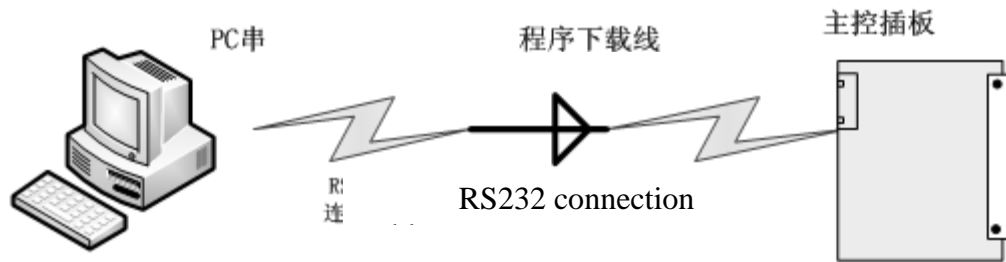
Note: The M800-04-E00 PCB update procedure is the same as M600-04-E00 PCB. Please refer to Fig 1.2.2-4.

Fig. 1.2.2-7: MAGLUMI800 analyzer master board 05 program download interface: J4



Fig. 1.2.2-8: MAGLUMI600/800 analyzer master board program download connections method





connections method schematic diagram

- 2) After connect line, start the computer and analyzer. Operate FLASHLOAD EXE. program on computer , select options as follows

Step1-Communications:

step	option	content	meaning
1	Device		write the flash out of chip
2	COM Port	COM1	Communication port
3	Baud Rate	115200	write the flash out of speed
4	Oscillator(MHz)	14.31818	Frequency (fixed)

Analyzer	PCB	Device#
Maglumi 600	M600-02-E00-Sample&Reagent	LPC2387
	M600-03-E00-Incubator&Washer&Pusher	LPC2387
	M600-04-E00-MeasureChamber	LPC2132
Maglumi 800	M800-02-E00-Sample Arm	LPC2387
	M800-03-E00-Washer	LPC2132
	M800-04-E00-MeasureChamber	LPC2312
	M800-05-E00-Multiple Modules	LPC2468

Step2-Erase:

step	option	content	meaning
1	Erase all Flash+Code Rd Prot	√	Remove all flash and codes

Step3-Hex File:

step	option	content	meaning
1	Hex Filehex document	select document written the flash out. These 3 master control boards have 3 different files respectively, the file names are corresponding to circuit names, provided by SNIBE

Step4-Option:

step	option	content	meaning
1	Verify after programming	√	Proofread after writing flash out

Completing to set the four major steps as above, as shown in the diagram below

Fig. 1.2.2-6: Procedure of MAGLUMI600/800 analyzer master board02-05 program upgrade

The screenshot shows a software interface for upgrading the analyzer master board. It is organized into three main sections:

- Step 1 - Communications:** Contains four configuration fields: Device (set to LPC2387), Baud Rate (set to 115200), COM Port (set to COM1), and Oscillator (KHz) (set to 14318.18).
- Step 2 - Hex File:** Contains a text field for the Hex File path (F:\Sample&Reagent.hex) and a 'Browse..' button.
- Step 3 - Operation:** Contains two buttons: 'Start' and 'Exit'.

At the bottom of the window, a status bar displays the message 'Download Success!'.

Step 5 - Start!:

Press the “start” button, software will start to write program into the CMOS chip .

After that, Software will display “finished” at left bottom.

Step6:

- 1) After writing flash out the program, exit Flash Download.EXE program
- 2) *Switch off analyzer*, separate data line, reconnect RS232 data line with analyzer’s RS232 interface



Upgrading program must be followe the principles, not charged when plug and pull out connecting lines, must turn off power supply when plug and pull out connecting lines, otherwise you'll burn master control circuit